

中华人民共和国金融行业标准

JR/T 0078—2014

银行间市场数据接口

Inter-bank market data interface

2014 - 1 - 16 发布

2014 - 1 - 16 实施

中国人民银行 发布

目 次

前言	IV
引言	V
1 范围	1
2 规范性引用文件	1
3 术语和定义	1
4 银行间市场数据接口描述	2
5 银行间市场数据接口规范维护与管理	3
6 应用编程接口规范	3
6.1 应用编程接口总体结构	3
6.2 编程接口定义	6
6.3 编程接口调用规范	16
6.4 编程接口异常处理规范	22
6.5 编程接口调用示例	25
7 IMIX 报文接口规范	40
7.1 报文格式简介	40
7.2 报文接口定义	41
7.3 基于 XML 的 IMIXML 接口定义	55
8 数据传输压缩接口规范	55
8.1 压缩算法定义	55
8.2 传输方式	56
8.3 压缩接口方法定义	56
9 数据落地接口规范	57
9.1 Store 数据落地规范	57
9.2 Queue 数据落地规范	59
9.3 数据落地编程接口规范	60
10 日志接口规范	63
11 配置文件接口规范	64
12 报文快速访问接口规范	69
13 订阅发布模式接口规范	69
13.1 主题 Topic 的定义	69
13.2 订阅报文定义	70
14 业务数据精度标准	70
14.1 报价数据精度标准	70

14.2 成交数据精度标准.....	72
附录 A (资料性附录) IMIX 协议元数据模板.....	75
附录 B (资料性附录) IMIX 协议元数据模板结构定义.....	265
参考文献.....	268
图 1 数据接口整体结构框图.....	3
图 2 Client 部分主要类图.....	5
图 3 Server 部分主要类图.....	6
图 4 Client 端数据接口建立时序图.....	17
图 5 Server 端数据接口建立时序图.....	18
图 6 Client 端数据接口会话销毁时序图.....	19
图 7 Server 端数据接口会话销毁时序图.....	20
图 8 Client 端数据交换时序图.....	21
图 9 Server 端数据交换时序图.....	22
图 10 IMIX 报文接口类图.....	42
图 11 数据传输压缩接口流程.....	55
图 12 数据压缩传输方式.....	56
图 13 Store 数据文件名示例.....	57
图 14 Sequms 文件结构.....	57
图 15 Body 文件结构.....	57
图 16 Header 文件结构.....	57
图 17 Session 文件结构.....	58
图 18 Queue 数据文件名示例.....	60
图 19 Time 文件结构.....	60
图 20 Queue 文件结构.....	60
图 21 Offset 文件结构.....	60
图 22 分层次主题命名.....	70
表 1 Client 部分主要类描述.....	4
表 2 Server 部分主要类描述.....	4
表 3 监听回调接口公共方法.....	6
表 4 IMIX 会话类公共方法.....	8
表 5 IMIX 应用类公共方法.....	10
表 6 事件回调接口公共方法.....	11
表 7 报文接收回调接口公共方法.....	11
表 8 报文发送回调接口公共方法.....	12
表 9 登录验证回调接口公共方法.....	13
表 10 IMIX 会话类公共方法.....	14
表 11 IMIX 应用类公共方法.....	16
表 12 Field 类公共方法.....	42
表 13 布尔型基类公共方法.....	43
表 14 BidPx 类公共方法.....	45

表 15	域集合类公共方法.....	45
表 16	报文基类公共方法.....	47
表 17	IMIX1.0 报文基类公共方法	50
表 18	ExecutionReport 报文类公共方法	51
表 19	NoUnderlyings 重复组域集合公共方法	52
表 20	IMIX 数据字典类公共方法	53
表 21	SessionTable 表结构	58
表 22	MessageTable 表结构	58
表 23	MessageStoreTable 表结构	59
表 24	数据落地编程接口公共方法.....	60
表 25	日志编程接口公共方法.....	63
表 26	会话 ID 属性.....	64
表 27	IMIX 配置文件说明	64
表 28	报价数据精度标准.....	70
表 29	成交数据精度标准.....	72

前 言

本标准依据GB/T 1.1-2009给出的规则起草。

本标准由全国金融标准化技术委员会（SAC/TC 180）归口。

本标准提出单位：中国外汇交易中心暨全国银行间同业拆借中心。

本标准负责起草单位：中国外汇交易中心暨全国银行间同业拆借中心。

本标准主要起草人：许再越、戴德毅、崔嵬、许琳、胡剑、姜才康、许继红、朱荣、酆永达、王成勇、叶胜国、孙小林、沈薇薇、茅廷、陈晓跃、孙英昊、崔奇、何帆、周毅、王晓光、赵俊峰、程晓松、尹秀资、刘丽莉、胡卫平、夏志江、方剑锋、徐振端。

本标准为首次制定。

引 言

本标准是根据银行间市场的业务需求制定的。本标准所包含的接口规范是银行间市场系统基于银行间市场业务数据交换协议（IMIX协议）实现数据交换的约定。本标准通过一组规范的接口属性及规范说明对数据接口进行描述。本标准是实施银行间市场系统的数据采集、数据交换和信息发布的重要基础标准。

银行间市场数据接口

1 范围

本标准规定了银行间市场业务（外汇交易、信用拆借、债券回购、现券买卖、票据等）数据交换和共享所使用的应用接口规范、使用方式和所使用的银行间市场数据交换报文的内容、格式及其使用方法。本标准的内容覆盖应用编程接口描述、数据传输压缩接口规范、数据落地接口规范、日志接口规范、配置接口规范、业务报文内容快速访问接口规范、订阅发布模式接口规范、业务数据精度标准。

本标准适用于银行间市场业务活动中涉及到的银行间市场系统的所有业务流程中的数据交换接口及所有使用银行间市场数据交换协议的相关系统。

2 规范性引用文件

下列文件对于本文件的应用是必不可少的。凡是注日期的引用文件，仅所注日期的版本适用于本文件。凡是不注日期的引用文件，其最新版本（包括所有的修改单）适用于本文件。

JR/T 0065-2011 银行间市场基础数据元

JR/T 0066-2011 银行间市场业务数据交换协议

3 术语和定义

下列术语和定义适用于本文件。

3.1

外汇交易 foreign exchange trading

在我国银行间市场进行的不同货币之间的交易。目前国内银行间外汇市场可进行人民币与外币的即期、远期、掉期交易。

3.2

外汇交易系统 foreign exchange trading system

外汇交易中心为会员之间进行外汇交易和资金清算所提供的电子系统。

3.3

银行间外汇交易市场 inter-bank foreign exchange trading market

中国外汇交易中心为会员间进行外汇交易（目前为人民币和外币之间的即期、远期、掉期交易）所提供的交易和清算服务场所或系统。

3.4

银行间市场 inter-bank market

银行间市场是金融市场体系的核心。在银行间市场产生的指数，如拆借利率指数、债券回购指数、债券收益率，是其他金融产品和衍生工具定价的基础。银行间市场由拆借市场、债券市场和人民币利率衍生品市场组成。通过信用拆借、质押式回购、买断式回购、现券买卖、债券借贷、债券远期、利率互换、远期利率协议等交易，金融机构可以利用银行间市场管理资金头寸、调整资产负债结构和进行投资理财。在银行间市场交易的证券种类包括国债、央行票据、金融债、次级债、公司债、国际开发机构债券、短期融资券、资产支持证券等。本币市场成员涵盖商业银行、证券公司、保险公司、信托公司、基金、企业年金等各类金融机构。

3.5

应用编程接口 application programming interface (API)

应用编程接口是软件系统不同组成部分衔接的约定。近年来金融系统软件的规模日益庞大，常常需要把复杂的系统划分成小的组成部分，编程接口的设计十分重要。程序设计的实践中，编程接口的设计首先要使软件系统的职责得到合理划分。良好的接口设计可以降低系统各部分的相互依赖，提高组成单元的内聚性，降低组成单元间的耦合程度，从而提高系统的维护性和扩展性。

3.6

银行间市场数据接口 inter-bank market data interface

银行间市场数据接口是银行间市场系统业务数据交换衔接的约定。包括银行间市场数据应用编程接口、业务数据使用规范、数据传输压缩加密规范等。

3.7

银行间市场业务数据交换 inter-bank market data exchange (IMIX)

银行间市场业务数据交换是银行间市场业务活动中涉及到的银行间市场系统的数据交换行为及内容约定。

3.8

银行间市场业务数据交换报文 inter-bank market data exchange message (IMIX message)

银行间市场业务数据交换报文是银行间市场业务活动中涉及到的银行间市场系统的数据交换的基本单位。

4 银行间市场数据接口描述

银行间市场数据接口是银行间市场基础数据元标准（标准号JR/T 0065）和银行间市场业务数据交换（IMIX）协议标准（标准号JR/T 0066）的延伸和系统实现。JR/T 0065标准规定了银行间市场业务活动中涉及到的银行间市场系统的数据元的标记、名称、说明及相关内容；JR/T 0066标准规定了银行间市场参与者之间进行银行间交易所需的通讯协议。JR/T 0065和JR/T0066标准组成了银行间市场业务数据标准体系，完整定义了相关业务系统数据交互所需使用的数据结构。在此基础上，银行间市场数据接口封装了银行间市场业务数据交换协议和银行间市场基础数据元标准的使用方法和系统实现，提供了规范的应用编程、IMIX报文等接口，完整定义了银行间市场业务系统数据交互技术标准。

银行间市场数据接口包含以下内容：

- a) 应用编程接口：基于 IMIX 协议构建银行业务应用系统编程接口，具体规范定义见第 6 章。

- b) 报文接口：基于 IMIX 协议的业务报文接口，具体规范定义见第 7 章。
- c) IMIX 传输压缩接口：基于 IMIX 协议的报文传输压缩接口，具体规范定义见第 8 章。
- d) 数据落地接口：基于 IMIX 协议的数据落地接口，具体规范定义见第 9 章。
- e) 日志接口：IMIX 应用系统日志接口，具体规范定义见第 10 章。
- f) 配置文件接口：IMIX 应用系统配置文件规范，具体描述见第 11 章。
- g) 报文快速访问接口：IMIX 报文内容快速访问规范，具体描述见第 12 章。
- h) 订阅发布模式接口：基于 IMIX 协议的订阅发布模式规范，具体描述见第 13 章。
- i) 业务精度标准：IMIX 协议的业务数据精度标准规范，具体描述见第 14 章。

银行间市场数据接口整体结构描述如图1所示。



图1 数据接口整体结构框图

5 银行间市场数据接口规范维护与管理

本标准由全国金融标准化技术委员会授权的机构负责维护与管理。鉴于银行间市场业务（包括外汇交易、信用拆借、债券回购、现券买卖、票据等）涉及银行机构的流动性等风险，监管部门因监管需要可对涉及使用此标准的银行间市场业务的信息系统进行延伸检查。

6 应用编程接口规范

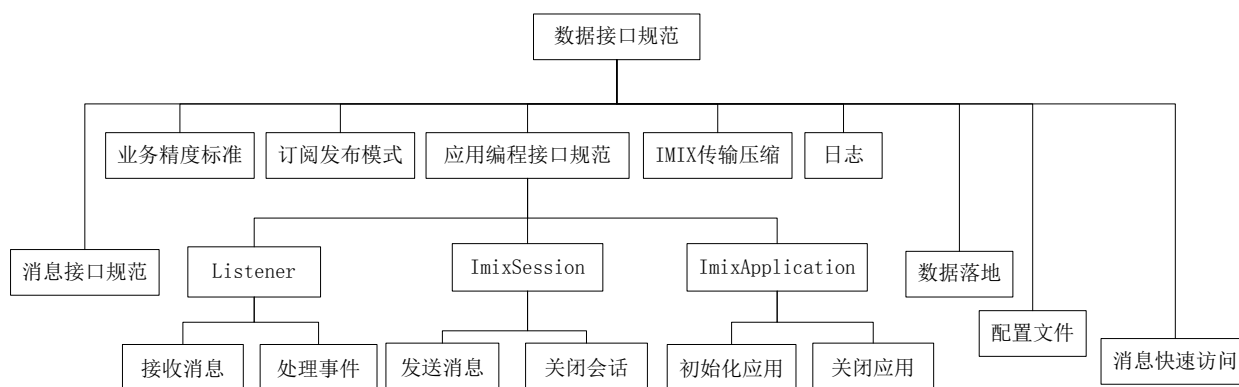
应用编程接口提供构建银行应用系统进行业务数据交换和共享功能必要的接口与方法。考虑到银行间市场业务系统平台繁多，本章定义了基于跨平台的Java编程语言的接口、方法、函数、参数及使用规范。

6.1 应用编程接口总体结构

使用应用编程接口构建系统时需要实现自定义的回调函数以完成对报文以及事件的处理，同时需要根据指定的配置文件创建标准 IMIX 会话。

标准 IMIX 会话分为 Initiator 和 Acceptor。Initiator 用于发起连接请求，Acceptor 监听特定端口并接受连接请求。

根据应用编程接口使用者的角色不同，编程接口分为Client部分和Server部分。Client部分封装了Initiator，主要用于发起连接请求；Server部分则封装了Initiator/Accpetor，用于接受连接请求并做验证。

Client部分主要类描述见表1。

表1 Client 部分主要类描述

序号	类名	描述
1	imix.client.core.Listener	提供给用户使用报文及事件回调函数。
2	imix.client.core.ImixSession	标准 IMIX 会话类。
3	imix.client.core.ImixApplication	所启动的 IMIX 应用实例。

Server部分主要类描述见表2。

表2 Server 部分主要类描述

序号	类名	描述
1	imix.core.api.EventListener	提供给用户事件回调函数。
2	imix.core.api.MessageReceiveListener	提供给用户报文接收回调函数。
3	imix.core.api.MessageSendListener	提供给用户报文发送回调函数。
4	imix.core.api.UserListener	提供给用户登录验证回调函数。
5	imix.core.api.ImixSession	标准 IMIX 会话类。支持 Initiator/Acceptor 类型。
6	imix.core.api.ImixApplication	所启动的 IMIX 应用实例。

Client部分主要类图如图2所示。



图2 Client 部分主要类图

Server部分主要类图如图3所示。

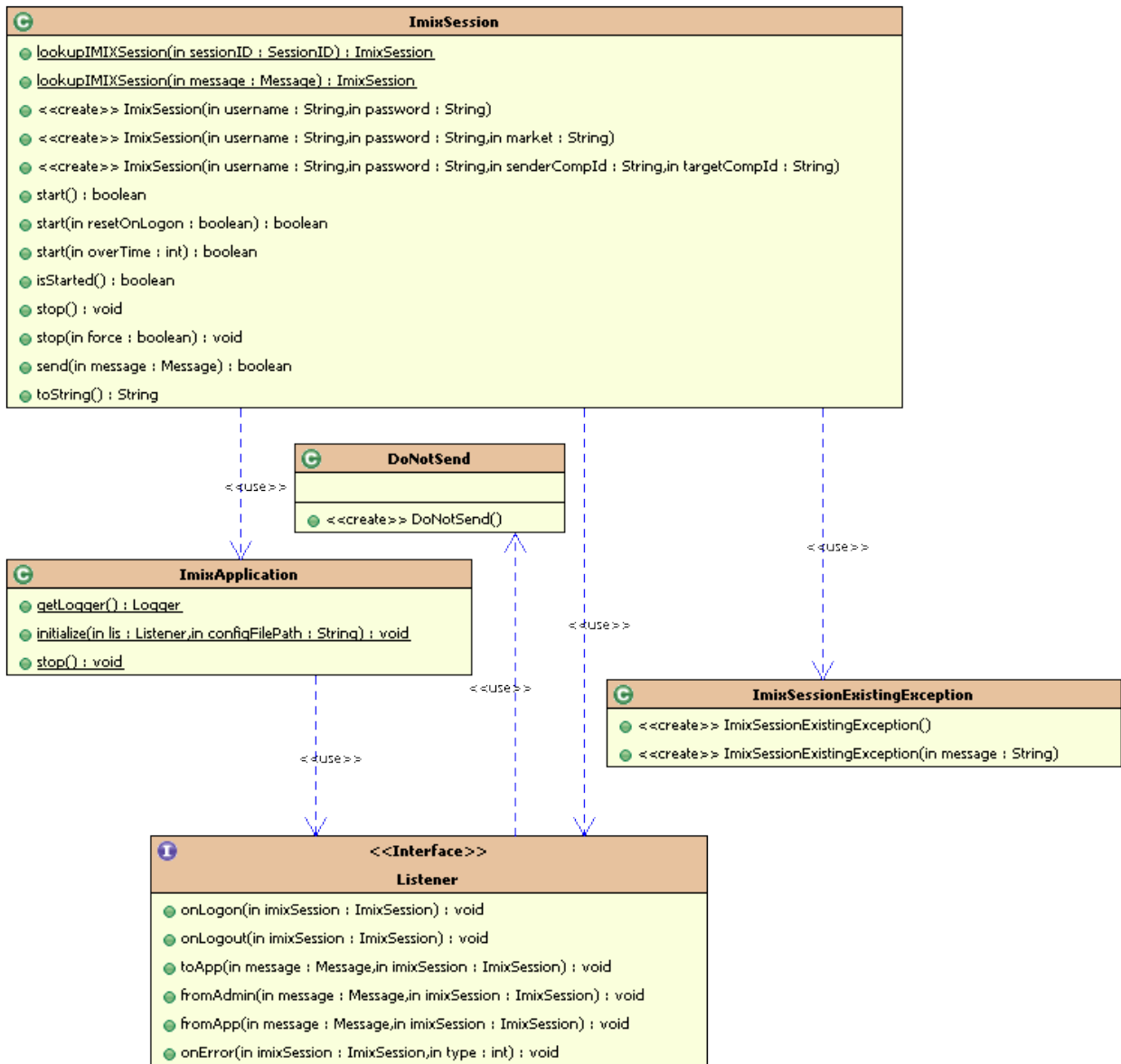

图3 Server 部分主要类图

6.2 编程接口定义

6.2.1 Client 部分

应用编程接口Client部分包含以下Interface及Class:

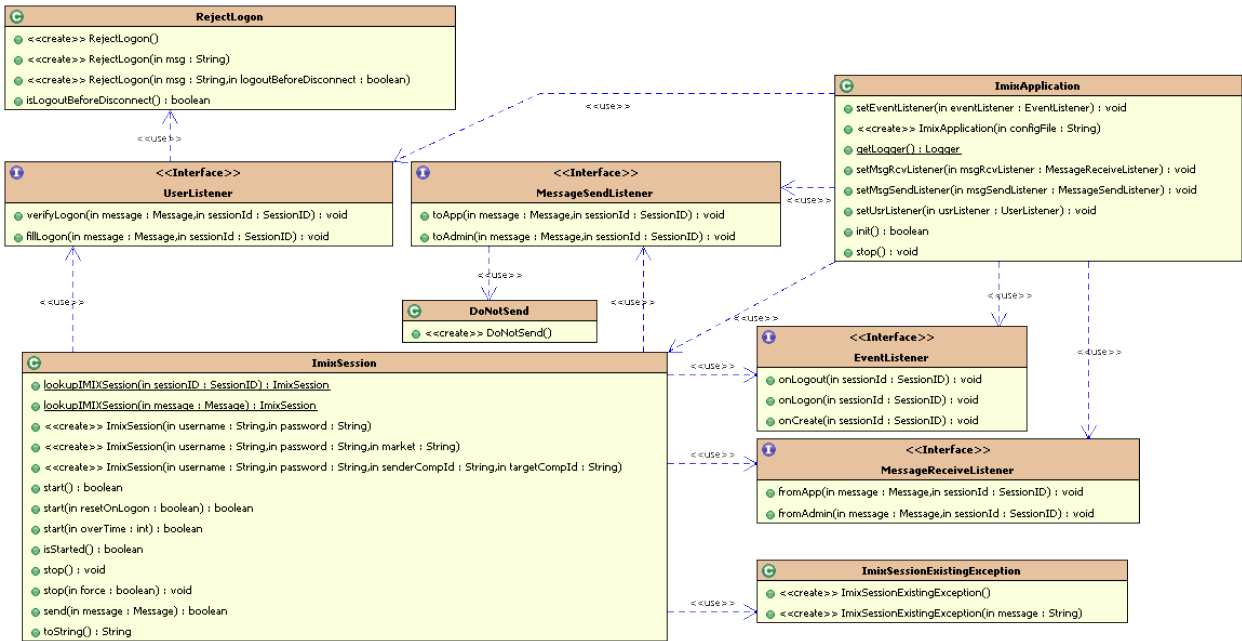
——Interface 名称: final public interface imix.client.core.Listener

此Interface定义收发数据各状态时的监听回调接口方法。其公共方法如表3。

表3 监听回调接口公共方法

报文回调接口方法		
public void	toApp(Message message, ImixSession imixSession) throws DoNotSend;	所有发出的应用类报文都会调用此回调。
public void	fromAdmin(Message message, ImixSession imixSession) throws FieldNotFound, IncorrectDataFormat, IncorrectTagValue;	所有收到的管理类报文都会调用此回调。
public void	fromApp(Message message, ImixSession imixSession) throws FieldNotFound, IncorrectDataFormat, IncorrectTagValue, UnsupportedMessageType;	所有收到的应用类报文都会调用此回调。
登陆事件回调接口方法		
public void	onLogon(ImixSession imixSession);	会话成功登陆后会调用此回调。
public void	onLogout(ImixSession imixSession);	会话结束后会调用此回调。
异常信息回调接口方法		
public void	onError(ImixSession imixSession, int type);	出现异常情况时会调用此回调。

Listener Interface接口方法定义如下:

a) toApp 方法

方法名称: toApp

返回类型: void

方法说明: 此回调方法会在任意报文发送时被调用。如此方法抛出 DoNotSend 异常, 则此报文将不会被发送。如果是因为序列号有 gap 在恢复 session 的时候导致 API 底层自动重发 (即 PossDup 被设置为 True, 43 号域), 此时 API 不会继续发这条报文, 取而代之的是发一条 sequence reset, 让对方跳过本条报文。应用场景比如当向市场发送一条已经过期的 Order 的报文时, 可以使用。

异常申明:

- 1) quickfix.DoNotSend 报文不发送异常, 具体参见相应类定义。

参数定义:

- 1) imix.Message message IMIX 报文对象类型, 具体参见相应类定义。
- 2) imix.client.core.ImixSession imixSession IMIX 会话对象类型, 具体参见相应类定义。

b) fromAdmin 方法

方法名称: fromAdmin

返回类型: void

方法说明: 此回调方法会在收到管理类报文时被调用。可能收到的管理类报文包括 Reject Session-level (MsgType=3) 报文和 logout (MsgType=5) 报文。并在报文中 Text 域包含登出或拒绝原因。如当应用发送的 logon 报文包含错误用户信息 (密码错误) 时, 此应用将收到 58 域包含错误码为 4 (4=密码错) 的 logout 报文。

异常申明:

- 1) imix.FieldNotFound 报文域未发现异常, 具体参见相应类定义。
- 2) imix.IncorrectDataFormat 数据格式错误异常, 具体参见相应类定义。
- 3) imix.IncorrectTagValue 数据域错误异常, 具体参见相应类定义。

参数定义:

- 1) imix.Message message IMIX 报文对象类型, 具体参见相应类定义。
- 2) imix.client.core.ImixSession imixSession IMIX 会话对象类型, 具体参见相应类定义。

c) fromApp 方法

方法名称: fromApp

返回类型: void

方法说明: 此回调方法会在收到业务类报文时被调用。此方法为构建应用系统核心接入点。如应用系统为卖方交易系统, 此方法将收到成交请求报文; 如应用系统为买方系统, 此方法将收到成交确认报文。如抛出 FieldNotFound 异常, 对端系统将收到拒绝报文表示相应的域缺失; 对于单一 IMIX Session 而言, 此方法是同步的, 即单一 IMIX Session 接收的报文会排队等待。

异常申明:

- 1) imix.FieldNotFound 报文域未发现异常, 具体参见相应类定义。
- 2) imix.IncorrectDataFormat 数据格式错误异常, 具体参见相应类定义。
- 3) imix.IncorrectTagValue 数据域错误异常, 具体参见相应类定义。
- 4) imix.UnsupportedMessageType 报文类型未支持异常, 具体参见相应类定义。

参数定义:

- 1) imix.Message message IMIX 报文对象类型, 具体参见相应类定义。
- 2) imix.client.core.ImixSession imixSession IMIX 会话对象类型, 具体参见相应类定义。

d) onLogon 方法

方法名称: onLogon

返回类型: void

方法说明: 此回调方法会在收到 IMIX 会话建立成功后调用。

异常申明: N/A

参数定义:

- 1) imix.client.core.ImixSession imixSession IMIX 会话对象类型, 具体参见相应类定义。

e) onLogout 方法

方法名称: onLogout

返回类型: void

方法说明: 此回调方法会在收到 IMIX 会话出现异常时调用。

异常申明: N/A

参数定义:

- 1) imix.client.core.ImixSession IMIX 会话对象类型, 具体参见相应类定义。
- 2) int type 错误码, 具体可由数据交换双方应用系统协商定义。

f) onError 方法

方法名称: onError

返回类型: void

方法说明: 此回调方法会在收到 IMIX 会话登出后调用。

异常申明: N/A

参数定义:

- 1) imix.client.core.ImixSession imixSession IMIX 会话对象类型, 具体参见相应类定义。

——**Class 名称: final public class imix.client.core.ImixSession**

标准IMIX会话类, 封装Initiator类型, 维护标准IMIX会话生命周期、定义所有操作。其公共方法如表4。

表4 IMIX 会话类公共方法

IMIX 会话类方法		
public static ImixSession	lookupIMIXSession(Message message);	根据接收到的报文检索对应的 IMIX 会话。
public static ImixSession	lookupIMIXSession(SessionID sessionID);	根据 SessionID, 检索对应的 IMIX 会话。
public Boolean	isStarted();	检查 IMIX 会话是否启动成功。
public Boolean	send(Message message);	发送报文到 IMIX 会话对端。
public synchronized boolean	start();	启动 IMIX 会话。
public synchronized boolean	start(int overTime);	启动 IMIX 会话并设定最长超时事件。
public synchronized void	stop();	停止 IMIX 会话。
public synchronized void	stop(boolean force);	不等待 IMIX 会话对端 Logout 报文, 强行终止会话。

Class ImixSession类方法定义如下:

a) lookupIMIXSession 方法

方法名称: lookupIMIXSession

方法类型: 静态

返回类型: imix.ImixSession IMIX会话类型。

方法说明：根据接收到的报文检索对应的IMIX会话。

异常申明：N/A

参数定义：

1) `imix.Message message` IMIX 报文对象类型，具体参见相应类定义。

b) `lookupIMIXSession` 方法

方法名称：`lookupIMIXSession`

方法类型：静态

返回类型：`imix.ImixSession` IMIX会话类型。

方法说明：根据会话ID检索对应的IMIX会话。

异常申明：N/A

参数定义：

1) `imix.SessionID sessionID` IMIX 会话 ID 对象类型，具体参见相应类定义。

c) `isStarted` 方法

方法名称：`isStarted`

返回类型：`boolean`

方法说明：检查IMIX会话是否启动成功。

异常申明：N/A

参数定义：N/A

d) `send` 方法

方法名称：`send`

返回类型：`boolean`

方法说明：发送报文到IMIX会话对端。发送成功返回`true`，失败返回`false`。

异常申明：N/A

参数定义：

1) `imix.Message message` IMIX 报文对象类型，具体参见相应类定义。

e) `start` 方法

方法名称：`start`

方法类型：同步

返回类型：`boolean`

方法说明：启动IMIX会话。成功返回`true`，失败返回`false`。

异常申明：N/A

参数定义：N/A

f) `start` 方法

方法名称：`start`

方法类型：同步

返回类型：`boolean`

方法说明：启动IMIX会话并设置最大超时时间。成功返回`true`，失败返回`false`。

异常申明：N/A

参数定义：

1) `int overTime` 超时时间，单位毫秒。

g) `stop` 方法

方法名称：`stop`

方法类型：同步

返回类型: void

方法说明: 停止IMIX会话。

异常申明: N/A

参数定义: N/A

h) stop 方法

方法名称: stop

方法类型: 同步

返回类型: void

方法说明: 根据参数强行停止IMIX会话或停止会话。强行停止会话将不等待对端logout报文。

异常申明: N/A

参数定义:

1) boolean force 是否强行停止会话。

——**Class 名称:** final public class imix.client.core.ImixApplication

标准IMIX应用类, 维护IMIX应用生命周期、定义所有操作。其公共方法如表5。

表5 IMIX 应用类公共方法

IMIX 应用类方法		
public static final Logger	getLogger();	得到 IMIX 应用使用的 Logger。
public static void	initialize(Listener lis, String configFilePath) throws ConfigError;	初始化 IMIX 应用。
public static void	stop();	关闭 IMIX 应用。

Class ImixApplication类方法定义如下:

a) getLogger 方法

方法名称: getLogger

方法类型: 静态

返回类型: org.slf4j.Logger slf4j框架Logger类型。

方法说明: 得到IMIX应用使用的Logger。

异常申明: N/A

参数定义: N/A

b) initialize 方法

方法名称: initialize

方法类型: 静态

返回类型: void

方法说明: 初始化IMIX应用。注册监听类并通过配置文件初始化应用。配置文件具体规范见相应章节。

异常申明: N/A

参数定义:

1) imix.Listener lis IMIX 回调接口实现类型。

2) String configFilePath 配置文件路径。

c) stop 方法

方法名称: stop

方法类型：静态

返回类型：void

方法说明：停止IMIX应用。

异常申明：N/A

参数定义：N/A

——**Class 名称**：`final public class quickfix.DoNotSend`

IMIX报文不发送异常，用于触发不发送报文行为。

6.2.2 Server 部分

应用编程接口Server部分包含以下Interface及Class：

——**Interface 名称**：`final public interface imix.core.api.EventListener`

事件回调接口，定义标准IMIX会话生命周期中各类事件回调接口。其公共方法如表6。

表6 事件回调接口公共方法

事件回调接口方法		
public void	<code>onLogout(ImixSession session);</code>	会话登出回调。
public void	<code>onLogon(ImixSession session);</code>	会话登录回调。
public void	<code>onCreate(ImixSession session);</code>	会话创建回调。

Interface `EventListener`接口方法定义如下：

a) `onLogon` 方法

方法名称：`onLogon`

返回类型：void

方法说明：此回调方法会在收到IMIX会话建立成功后调用。

异常申明：N/A

参数定义：

1) `imix.core.api.ImixSession imixSession` IMIX 会话对象类型，具体参见相应类定义。

b) `onLogout` 方法

方法名称：`onLogout`

返回类型：void

方法说明：此回调方法会在收到IMIX会话出现异常时调用。

异常申明：N/A

参数定义：

1) `imix.core.api.ImixSession imixSession` IMIX 会话对象类型，具体参见相应类定义。

c) `onCreate` 方法

方法名称：`onCreate`

返回类型：void

方法说明：此回调方法会在收到IMIX会话建立时调用。

异常申明：N/A

参数定义：

1) `imix.core.api.ImixSession imixSession` IMIX 会话对象类型，具体参见相应类定义。

——**Interface 名称**：`final public interface imix.core.api.MessageReceiveListener`

此接口类定义报文接收回调接口。其公共方法如表7。

表7 报文接收回调接口公共方法

报文回调		
public void	fromAdmin(Message message, ImixSession session) throws FieldNotFound, IncorrectDataFormat, IncorrectTagValue, UnsupportedMessageType, IOException;	所有收到的管理类报文都会调用此回调。
public void	void fromApp(Message message, ImixSession sessionId) throws FieldNotFound, IncorrectDataFormat, IncorrectTagValue, UnsupportedMessageType, IOException;	所有收到的应用类报文都会调用此回调。

Interface MessageReceiveListener接口方法定义如下：

a) fromAdmin 方法

方法名称：fromAdmin

返回类型：void

方法说明：此回调方法会在收到管理类报文时被调用。可能收到的管理类报文包括Reject Session-level (MsgType=3) 报文和logout (MsgType=5) 报文。并在报文中Text域包含登出或拒绝原因。如当应用发送的logon报文包含错误用户信息（密码错误）时，此应用将收到58域包含错误码为4（=密码错）的logout报文。

异常申明：

- 1) imix.FieldNotFound 报文域未发现异常，具体参见相应类定义。
- 2) imix.IncorrectDataFormat 数据格式错误异常，具体参见相应类定义。
- 3) imix.IncorrectTagValue 数据域错误异常，具体参见相应类定义。

参数定义：

- 1) imix.Message message IMIX 报文对象类型，具体参见相应类定义。
- 2) imix.core.api.ImixSession imixSession IMIX 会话对象类型，具体参见相应类定义。

b) fromApp 方法

方法名称：fromApp

返回类型：void

方法说明：此回调方法会在收到业务类报文时被调用。此方法为构建应用系统核心接入点。如应用系统为卖方交易系统，此方法将收到成交请求报文；如应用系统为买方系统，此方法将收到成交确认报文。如抛出FieldNotFound异常，对端系统将收到拒绝报文表示相应的域缺失；对于单一IMIX Session而言，此方法是同步的，即单一IMIX Session接收的报文会排队等待。

异常申明：

- 1) imix.FieldNotFound 报文域未发现异常，具体参见相应类定义。
- 2) imix.IncorrectDataFormat 数据格式错误异常，具体参见相应类定义。
- 3) imix.IncorrectTagValue 数据域错误异常，具体参见相应类定义。
- 4) imix.UnsupportedMessageType 报文类型未支持异常，具体参见相应类定义。

参数定义：

- 1) imix.Message message IMIX 报文对象类型，具体参见相应类定义。
- 2) imix.core.api.ImixSession imixSession IMIX 会话对象类型，具体参见相应类定义。

——**Interface 名称：**final public interface imix.core.api.MessageSendListener

此接口类定义报文发送时的回调接口。其公共方法如表8。

表8 报文发送回调接口公共方法

报文回调		
public void	toApp(Message message, ImixSession imixSession) throws DoNotSend;	所有发出的应用类报文都会调用此回调。
public void	toAdmin(Message message, ImixSession imixSession);	所有发送管理类报文都会调用此回调。

Interface MessageSendListener接口方法定义如下：

a) toApp 方法

方法名称：toApp

返回类型：void

方法说明：此回调方法会在任意报文发送时被调用。如此方法抛出DoNotSend异常，则此报文将不会被发送。如果是因为序列号有gap在恢复session的时候导致API底层自动重发（即PossDup被设置为True，43号域），此时API不会继续发这条报文，取而代之的是发一条sequence reset，让对方跳过本条报文。应用场景比如当向市场发送一条已经过期的Order的报文时，可以使用。

异常申明：

- 1) quickfix.DoNotSend 报文不发送异常，具体参见相应类定义。

参数定义：

- 1) imix.Message message IMIX 报文对象类型，具体参见相应类定义。
- 2) imix.core.api.ImixSession imixSession IMIX 会话对象类型，具体参见相应类定义。

b) toAdmin 方法

方法名称：toAdmin

返回类型：void

方法说明：此回调方法会在任意管理类报文发送时被调用。

异常申明：N/A

参数定义：

- 1) imix.Message message IMIX 报文对象类型，具体参见相应类定义。
- 2) imix.core.api.ImixSession imixSession IMIX 会话对象类型，具体参见相应类定义。

——**Interface 名称：final public interface imix.core.api.UserListener**

此接口类定义登录验证时的回调接口。其公共方法如表9。

表9 登录验证回调接口公共方法

登录验证回调接口		
public void	verifyLogon(Message message, ImixSession session) throws FieldNotFound, IncorrectDataFormat, IncorrectTagValue, RejectLogon;	验证登录报文时调用此回调。
public void	void fillLogon(Message message, ImixSession session);	发送登录报文时会调用此回调。

Interface UserListener接口方法定义如下：

a) verifyLogon 方法

方法名称：verifyLogon

返回类型：void

方法说明：此方法会在验证登录报文时被调用。

异常申明：

- 1) imix.FieldNotFound 报文域未发现异常，具体参见相应类定义。
- 2) imix.IncorrectDataFormat 数据格式错误异常，具体参见相应类定义。
- 3) imix.IncorrectTagValue 数据域错误异常，具体参见相应类定义。

4) `imix.engine.core.RejectLogon` 拒绝登录异常，具体参见相应类定义。

参数定义：

1) `imix.Message message` IMIX 报文对象类型，具体参见相应类定义。

2) `imix.core.api.ImixSession imixSession` IMIX 会话对象类型，具体参见相应类定义。

b) `fillLogon` 方法

方法名称：`fillLogon`

返回类型：`void`

方法说明：此方法会在发送登录报文时被调用。

异常申明：`N/A`

参数定义：

1) `imix.Message message` IMIX 报文对象类型，具体参见相应类定义。

2) `imix.core.api.ImixSession imixSession` IMIX 会话对象类型，具体参见相应类定义。

——**Class 名称：**`final public class imix.core.api.ImixSession`

标准IMIX会话类，封装Initiator/Acceptor类型会话。其公共方法如表10。

表10 IMIX 会话类公共方法

IMIX会话类方法		
<code>public static ImixSession</code>	<code>lookupIMIXSession(Message message);</code>	根据接收到的报文检索对应的 IMIX 会话。
<code>public static ImixSession</code>	<code>lookupIMIXSession(SessionID sessionId);</code>	根据 SessionID, 检索对应的 IMIX 会话。
<code>public Boolean</code>	<code>isStarted();</code>	检查 IMIX 会话是否启动成功。
<code>public Boolean</code>	<code>send(Message message);</code>	发送报文到 IMIX 会话对端。
<code>public synchronized boolean</code>	<code>start();</code>	启动 IMIX 会话。
<code>public synchronized boolean</code>	<code>start(int overTime);</code>	启动 IMIX 会话并设定最长超时事件。
<code>public synchronized void</code>	<code>stop();</code>	停止 IMIX 会话。
<code>public synchronized void</code>	<code>stop(boolean force);</code>	不等待 IMIX 会话对端 Logout 报文, 强行终止会话。

Class `ImixSession`类方法定义如下：

a) `lookupIMIXSession` 方法

方法名称：`lookupIMIXSession`

方法类型：静态

返回类型：`imix.ImixSession` IMIX会话类型。

方法说明：根据接收到的报文检索对应的IMIX会话。

异常申明：`N/A`

参数定义：

1) `imix.Message message` IMIX 报文对象类型，具体参见相应类定义。

b) `lookupIMIXSession` 方法

方法名称：`lookupIMIXSession`

方法类型：静态

返回类型：`imix.ImixSession` IMIX会话类型。

方法说明：根据会话ID检索对应的IMIX会话。

异常申明: N/A

参数定义:

1) `imix.SessionID sessionID` IMIX 会话 ID 对象类型, 具体参见相应类定义。

c) `isStarted` 方法

方法名称: `isStarted`

返回类型: `boolean`

方法说明: 检查IMIX会话是否启动成功。

异常申明: N/A

参数定义: N/A

d) `send` 方法

方法名称: `send`

返回类型: `boolean`

方法说明: 发送报文到IMIX会话对端。发送成功返回`true`, 失败返回`false`。

异常申明: N/A

参数定义:

1) `imix.Message message` IMIX 报文对象类型, 具体参见相应类定义。

e) `start` 方法

方法名称: `start`

方法类型: 同步

返回类型: `boolean`

方法说明: 启动IMIX会话。成功返回`true`, 失败返回`false`。

异常申明: N/A

参数定义: N/A

f) `start` 方法

方法名称: `start`

方法类型: 同步

返回类型: `boolean`

方法说明: 启动IMIX会话并设置最大超时时间。成功返回`true`, 失败返回`false`。

异常申明: N/A

参数定义:

1) `int overTime` 超时时间, 单位毫秒。

g) `stop` 方法

方法名称: `stop`

方法类型: 同步

返回类型: `void`

方法说明: 停止IMIX会话。

异常申明: N/A

参数定义: N/A

h) `stop` 方法

方法名称: `stop`

方法类型: 同步

返回类型: `void`

方法说明: 根据参数强行停止IMIX会话或停止会话。强行停止会话将不等待对端`logout`报文。

异常申明: N/A

参数定义:

1) boolean force 是否强行停止会话。

——**Class 名称:** final public class imix.core.api.ImixApplication

IMIX应用类, 维护IMIX应用。其公共方法如表11。

表11 IMIX 应用类公共方法

IMIX应用类方法		
public static final Logger	getLogger();	得到IMIX应用使用的Logger。
public static void	initialize(Listener lis, String configFilePath) throws ConfigError;	初始化IMIX应用。
public static void	stop();	关闭IMIX应用。

Class ImixApplication类方法定义如下:

a) getLogger 方法

方法名称: getLogger

方法类型: 静态

返回类型: org.slf4j.Logger slf4j框架Logger类型。

方法说明: 得到IMIX应用使用的Logger。

异常申明: N/A

参数定义: N/A

b) initialize 方法

方法名称: initialize

方法类型: 静态

返回类型: void

方法说明: 初始化IMIX应用。注册监听类并通过配置文件初始化应用。配置文件具体规范见相应章节。

异常申明: N/A

参数定义:

1) imix.Listener lis IMIX 回调接口实现类型。

2) String configFilePath 配置文件路径。

c) stop 方法

方法名称: stop

方法类型: 静态

返回类型: void

方法说明: 停止IMIX应用。

异常申明: N/A

参数定义:

——**Class 名称:** final public class imix.engine.core.DoNotSend

IMIX报文不发送异常, 用以触发不发送报文行为。

——**Class 名称:** final public class imix.engine.core.RejectLogon

IMIX会话登录异常, 用以触发发送Logout报文行为。

6.3 编程接口调用规范

本条定义了构建系统时各类场景编程接口的调用规范及通用的异常流程处理规范。

6.3.1 数据接口会话建立

Client端数据接口会话建立时序如图4。



图4 Client 端数据接口建立时序图

流程说明：

- 用户系统调用 `ImixApplication.intialize` 方法进行初始化。
 - 调用 `ImixSession` 构造方法创建 `ImixSession` 会话实例。
 - 调用 `ImixSession.start` 方法启动会话，如启动成功则调用 `Listener.onLogon` 回调方法。
 - 调用 `ImixSession.start` 方法启动会话，如启动失败则调用 `Listener.onLogout` 回调方法。
- Server端数据接口会话建立时序如图5。

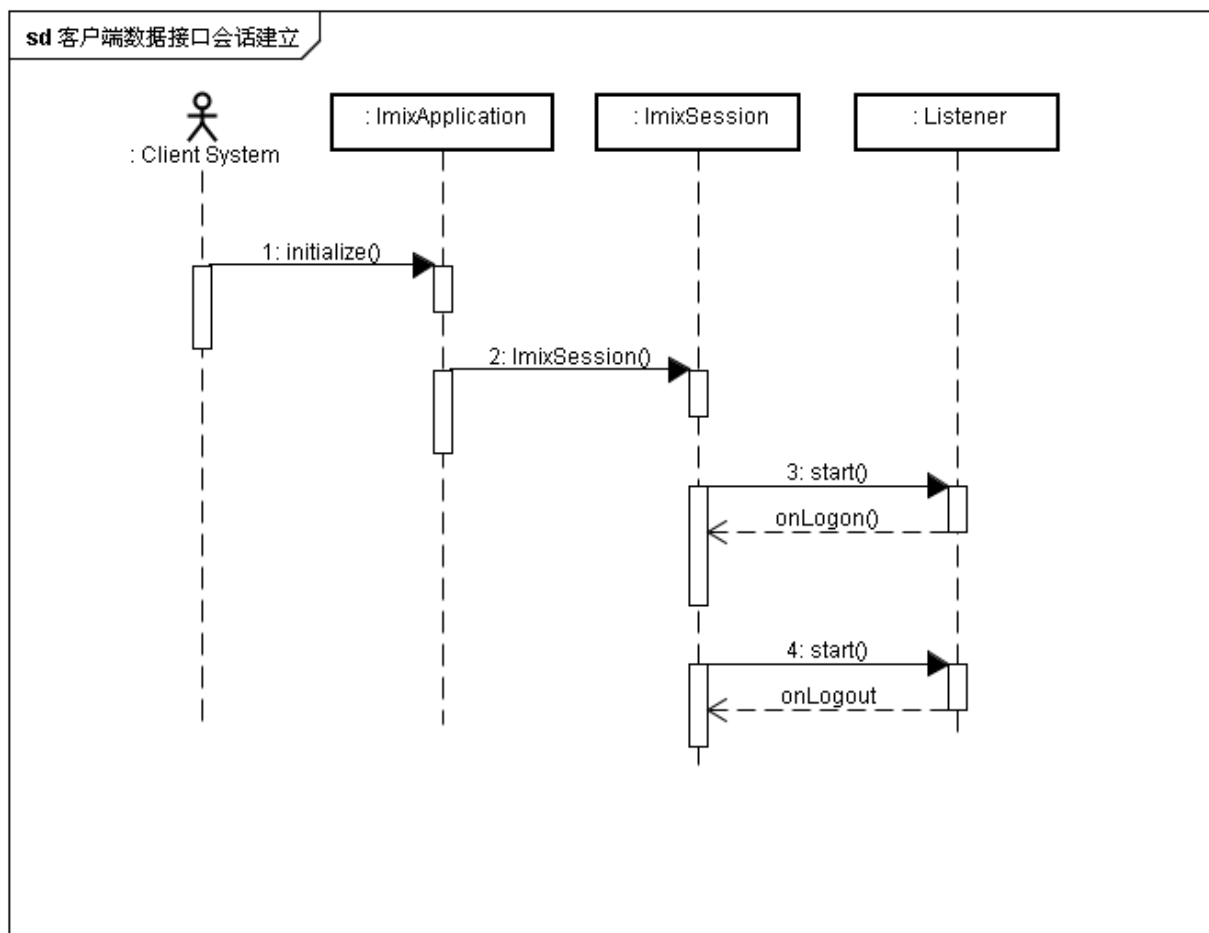

图5 Server 端数据接口建立时序图

流程说明：

- a) 服务器系统调用 ImixApplication.intialize 方法进行初始化。
- b) 收到客户端发送的 Logon 登录请求后，ImixApplication 调用 fromAdmin 方法，通知 MessageReceiveListener。
- c) MessageReceiveListener 实例调用 fromAdmin 回调方法。
- d) 收到客户端发送的 Logon 登录请求后，ImixApplication 调用 fromAdmin 方法，通知 UserListener。
- e) UserListener 实例调用 verifyLogon 回调方法。

6.3.2 数据接口会话销毁

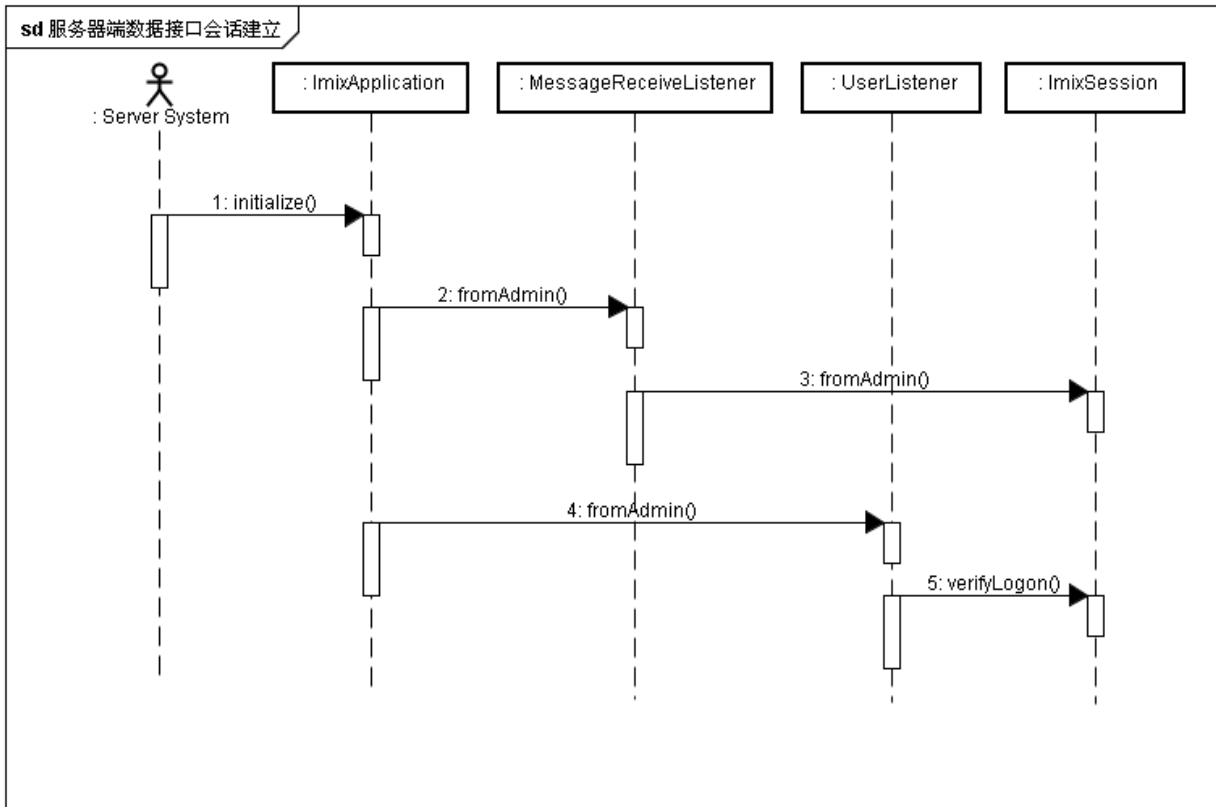
Client端数据接口会话销毁时序如图6。



图6 Client 端数据接口会话销毁时序图

流程说明：

- a) 调用 ImixSession 方法主动销毁会话。
- b) Listener.onLogout 回调方法被调用。
- c) 如出现会话状态异常，Listener.onLogout 回调方法被调用；并 Listener.onError 回调方法被调用。

Server端数据接口会话销毁时序如图7。

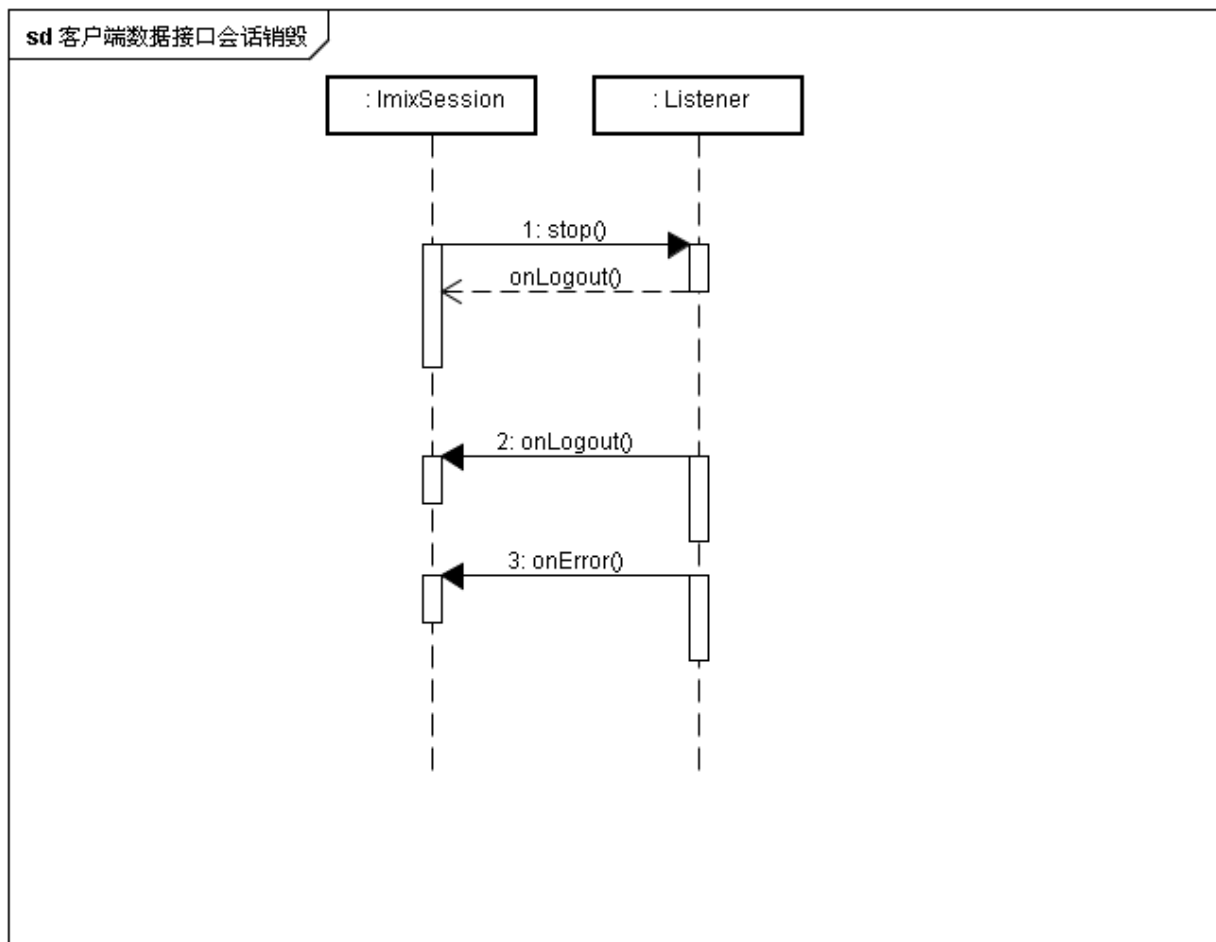

图7 Server 端数据接口会话销毁时序图

流程说明：

- a) 收到客户端发来 Logout 报文，MessageReceiveListener.fromAdmin 回调方法被调用。
- b) UserListener.onLogout 回调方法被调用。
- c) 服务端主动断开会话，调用 ImixSession.stop 方法；Listener.onLogout 回调方法被调用。

6.3.3 数据交换

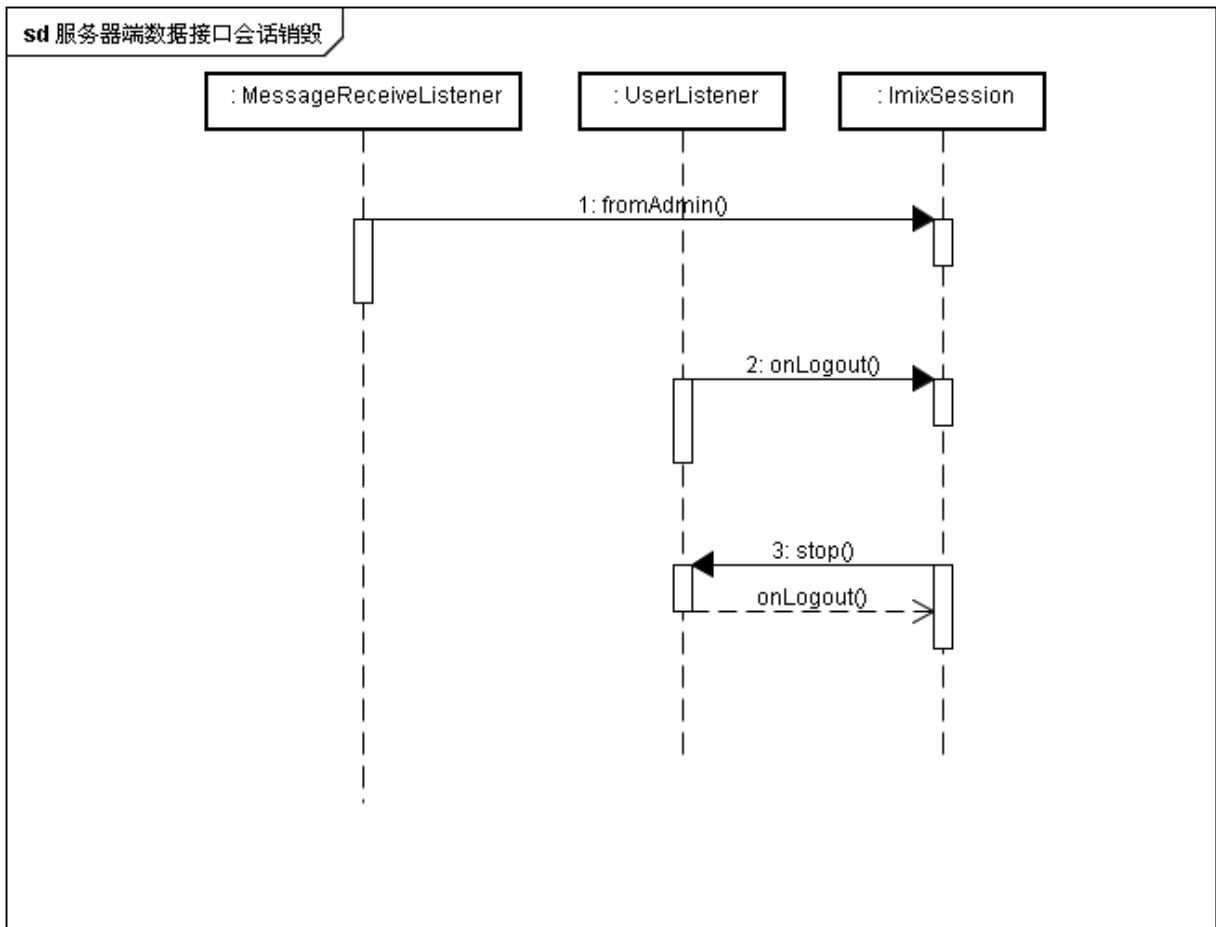
Client端数据交换时序如图8。



图8 Client 端数据交换时序图

流程说明:

- a) 调用 `ImixSession.send` 方法发送报文; `Listener.toApp` 回调方法被调用。
- b) 如收到 Admin 报文, `Listener.fromAdmin` 回调方法被调用。
- c) 如收到 App 报文, `Listener.fromApp` 回调方法被调用。

Server端数据交换时序如图9。

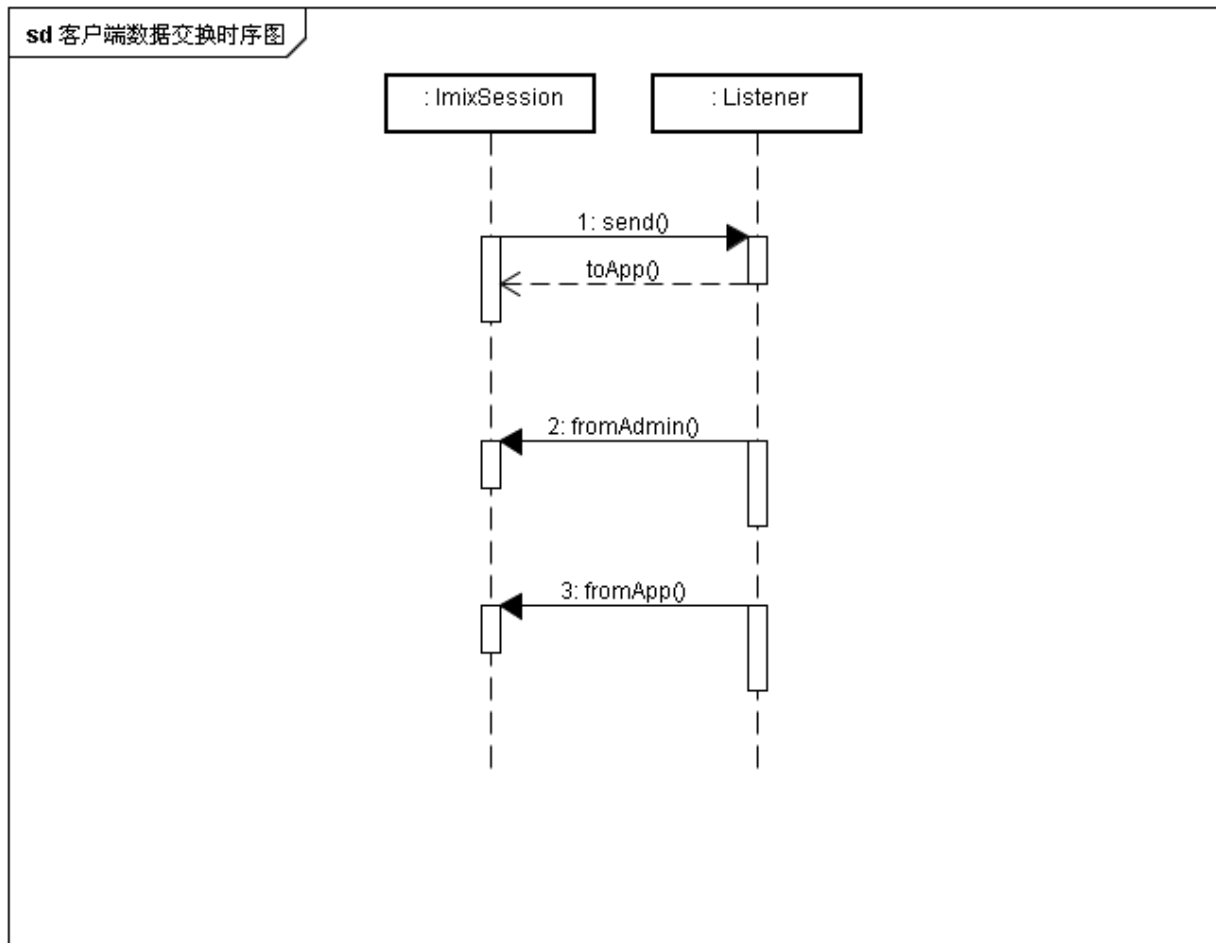

图9 Server 端数据交换时序图

流程说明:

- a) 调用 ImixSession.send 方法发送 Admin 报文; MessageSendListener.toAdmin 回调方法被调用。
- b) 调用 ImixSession.send 方法发送 App 报文; MessageSendListener.toApp 回调方法被调用。
- c) 如收到 Admin 报文, MessageReceiveListener.fromAdmin 回调方法被调用。
- d) 如收到 App 报文, MessageReceiveListener.fromApp 回调方法被调用。

6.4 编程接口异常处理规范

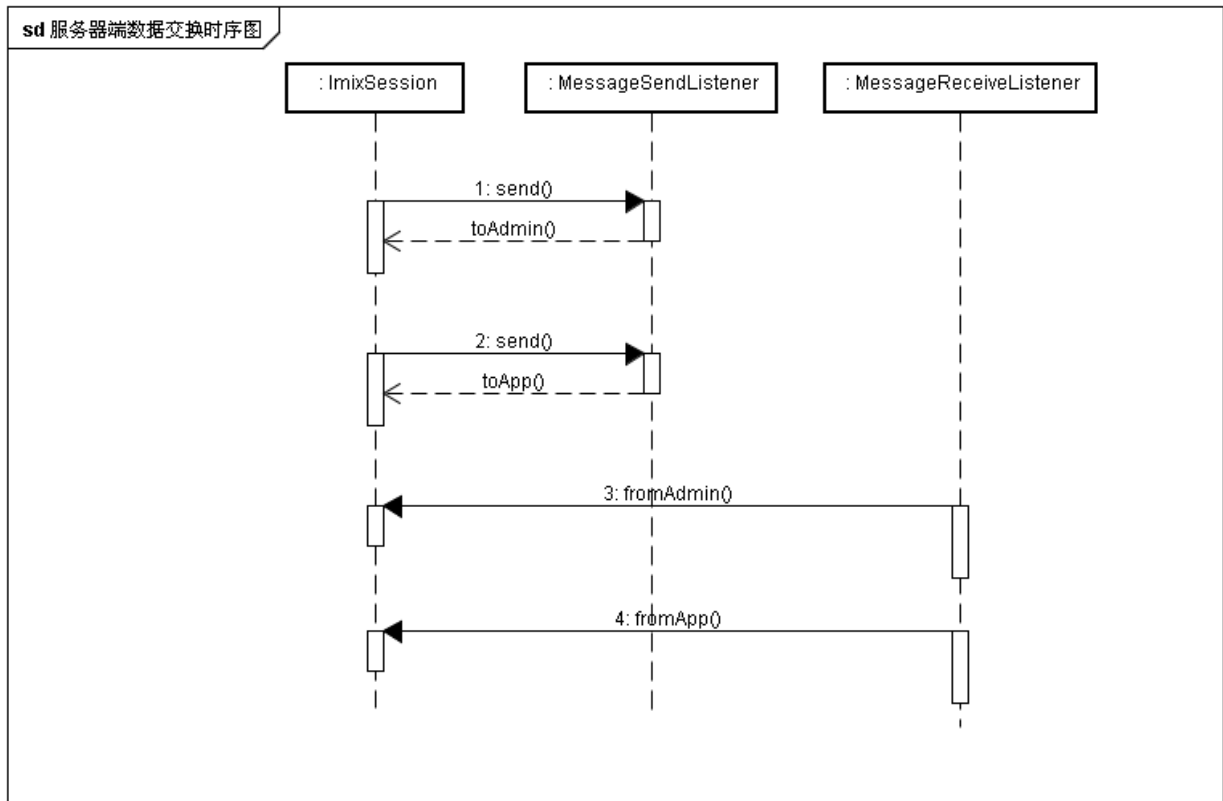
本条定义了编程接口异常返回码、异常流程处理及异常报文格式说明。

6.4.1 异常返回码

编程接口规定 1 至 100000 为保留异常返回码; 100000 以上为自定义码, 开放给客户系统使用。

返回码定义如下:

- 1=Logged in
- 2=Not logged in
- 3=User not recognized
- 4>Password incorrect
- 7=Client's SenderCompID is not right
- 8=Client's SenderSubID is not right
- 11=client logout
- 12=agent logout

13=hub logout
 14=server logout
 15=client not working(BE message,client logout or crashes)
 16=agent not working
 17=server not working
 18=hub or server not working
 19=username is null
 20=bad CompID
 21=can not find the correct Session to Hub
 22=schedule is overtime

6.4.2 异常处理规范

异常类型和处理规范定义如下：

——public class **ConfigError** extends java.lang.Exception

此异常在接口检测到配置错误时抛出。用户应用捕获此异常后，需检测相关配置错误、进行相应修正并再次处理。常见的可能引发配置错误异常的情况包括：

- a) 配置文件读取失败，如配置文件不存在、无读取权限、读取过程被强制终端等。
- b) 缺少关键配置项信息，如缺少 SessionID 相关配置项、缺少版本信息等。
- c) 配置项错误配置，如配置重复的 SessionID、数据字典路径错误、数据字典文件内容错误等。

——public static class DataDictionary.Exception extends java.lang.RuntimeException

此异常为DataDictionary对象内建静态异常类，在数据字典处理相关过程出现错误后抛出。用户应用捕获此异常后，需重新建立DataDictionary对象实例。常见的可能引发此异常的情况包括：

- a) 数据字典文件不存在。
- b) 应用无数据字典文件读权限。
- c) 应用读数据字典文件时出现 IO 错误。

——public class **DoNotSend** extends java.lang.Exception

用户应用可以通过抛出此异常用于终止发送或重发一个报文。用户应用可根据需求自行设计是否持久化终止发送的报文内容。常见用户应用可能需终止发送的情况包括：

- a) 用户应用在发送报文前检测到报文内容异常。
- b) 用户应用在发送报文前检测到会话状态异常。
- c) 用户应用在发送报文前检测到其他异常。

——public class **FieldConvertError** extends java.lang.Exception

IMIX域值转换问题异常。当无法正常将报文内域内容转换为域对象时抛出。用户应用可根据需求自行设计在该错误发生时，应用是否继续处理。常见域值转换问题场景包括：

- a) Int 转换错误。
- b) Boolean 转换错误。
- c) Char 转换错误。
- d) 日期转换错误。
- e) Double 转换错误。
- f) Decimal 转换错误。

——public class **FieldException** extends java.lang.RuntimeException

报文域值运行时异常。在数据交互双方发送的报文未按约定规则封装时抛出，通常会引发会话层的报文拒绝场景（发送拒绝类型报文，详见JR/T 0066标准中相关规定）。建议用户应用在捕获此异常后按JR/T 0066中相关规定发送会话拒绝报文。常见发生报文域值运行时异常的情况包括：

- a) 0 - 存在无效的域
- b) 1 - 该消息中必须的域丢失
- c) 2 - 该消息中出现未曾定义的域
- d) 3 - 未定义域号
- e) 4 - 域未赋值
- f) 5 - 域取值错误（范围溢出）
- g) 6 - 取值格式错误
- h) 7 - 解密错误
- i) 8 - 签名错误
- j) 9 - 会话标识错误
- k) 10 - 发送时间精度错误
- l) 11 - 无效的消息类型
- m) 12 - XML 验证错误
- n) 13 - 同一个域多次出现（非重复组）
- o) 14 - 有序的域出现次序错误
- p) 15 - 重复组域次序错误
- q) 16 - 重复组重复次数错误
- r) 17 - 非 data 数据域中出现域界定符

——public class **FieldNotFound** extends java.lang.Exception

在报文中读取域未找到时抛出的异常。用户应用捕获此异常时，需确定是在正确的报文区域内读取域，如报文头域需在报文头区块中读取，直接在报文体中读取会导致错误。

——public class **IncorrectDataFormat** extends java.lang.Exception

域格式错误异常。IMIX报文中域均有格式规定（详见JR/T 0066标准中相关规定），报文中域内容未按规定格式填写，数据接口抛出此异常。用户应用需捕获此异常并按需求设计处理方式。此异常可视为**FieldConvertError**异常的子集。当域格式错误时，对用户应用暴露的通常为**IncorrectDataFormat**异常。常见导致域格式错误异常发生的情况包括：

- a) 日期格式错误。
- b) 双精度格式错误。
- c) 整型格式错误。
- d) 布尔型格式错误。
- e) 字符型格式错误。
- f) 其他强类型域格式错误，通常为枚举值不符。

——public class **IncorrectTagValue** extends java.lang.Exception

当域号在数据字典中未定义时由数据接口抛出的异常。通常是由于数据交互双方使用的IMIX协议版本不一致导致。用户应用可根据自身需求，决定是否忽略此异常。

——public class **InvalidMessage** extends java.lang.Exception

非法报文异常，在报文不合规定时由数据接口抛出。用户应用捕获后根据自身需求决定是否忽略或请求重发。导致报文异常的场景，除上述各类异常外，常见的还包括：

- a) 分隔符错误。
- b) 等号错误。

- c) 域号格式错误。
- d) 报文类型未定义。
- e) 报文头域乱序。
- f) 域重复设置。

——public class **NoTagValue** extends java.lang.RuntimeException

域值未定义异常，在某个域号下未设置域值时由接口抛出。

——public class **RejectLogon** extends java.lang.Exception

此异常引发登陆请求拒绝，并立即断开会话连接。用户应用在收到登陆请求报文后，如验证失败，可抛出此异常，用于断开连接。

——public class **RuntimeError** extends java.lang.RuntimeException

用户应用引发的严重的运行时错误。用户应用必须捕获并处理。

——public class **SessionNotFound** extends java.lang.Exception

会话未定义异常。通常因配置错误引发。用户应用捕获此异常后，需检测相关配置文件并重启应用。

——public class **UnsupportedMessageType** extends java.lang.Exception

报文类型未支持异常。通常是由于用户应用使用的IMIX协议版本过久导致。用户应用捕获此异常后可根据需求决定是否更新协议版本并重启应用。

6.4.3 异常流程处理规范

常见异常流程处理规范定义如下：

——登录异常

验证登录报文未通过时，如密码错等，需在UserListener.verifyLogon方法中抛出RejectLogon异常，RejectLogon异常中的message将作为拒绝登录原因填充至返回给客户端的Logout报文。

——发送报文异常

发送报文过程中，可在Listener.toApp方法中实现校验逻辑，如出现异常，需抛出DoNotSend异常，中断报文发送流程。

——接收报文异常

接收报文过程中，可在Listener.fromApp方法中实现校验逻辑，如出现异常，根据异常种类，分别抛出FieldNotFound、IncorrectDataFormat、IncorrectTagValue、UnsupportMessageType，以中断该报文接收流程。

6.4.4 异常对象规范

各类异常均继承自java.lang.Exception类和java.lang.RuntimeException类。

6.5 编程接口调用示例

基于应用编程接口，用户可构建包括Client端和Server端在内的业务数据交换系统。举例说明如下：

——Client 部分

示例1：Client 应用类，用于创建 Client 端应用、管理会话生命周期以及发送 IMIX 报文。

```
/**
 * Client.java
 *
 * Copyright (c) 2007 China Foreign Exchange Trade System and National Interbank Funding
 Center.
 * Building 30,1387 zhangdong Road, Shanghai, China.
```

```

* All rights reserved.
*
* "[Description of code or deliverable as appropriate] is the copyrighted,
* proprietary property of State Street Bank and Trust Company and its
* subsidiaries and affiliates which retain all right, title and interest
* therein."
*
* Revision History
*
* Date           Programmer           Notes
* -----
* 2007-8-24     Mike Gu, Bill Zhou       initial
*/

```

```
package demo;
```

```
import java.util.concurrent.BlockingQueue;
```

```
import java.util.concurrent.LinkedBlockingQueue;
```

```
import imix.ConfigError;
```

```
import imix.DataDictionary;
```

```
import imix.InvalidMessage;
```

```
import imix.Message;
```

```
import imix.client.core.ImixApplication;
```

```
import imix.client.core.ImixSession;
```

```
import imix.client.core.ImixSessionExistingException;
```

```
import imix.imix10.ExecutionReport;
```

```
public class Client {
```

```
    private static BlockingQueue<Message> messages = new LinkedBlockingQueue<Message>();
```

```
    public static void main(String[] args) throws ConfigError, InvalidMessage,
    InterruptedException {
```

```
        DataDictionary dd = new DataDictionary("IMIX10.xml");
```

```
        ClientListener listener = new ClientListener();
```

```
        String configfile = "";
```

```
        if (args.length == 0) {
```

```
            configfile = "cfg/client.cfg";
```

```
        } else if (args.length == 1) {
```

```
            configfile = args[0];
```

示例2: Listener 回调方法实现类, 用于处理接收会话事件和 IMIX 报文。

```

/**
 * Demo.java
 *
 * Copyright (c) 2007 China Foreign Exchange Trade System and National Interbank Funding
Center.
 * Building 30,1387 zhangdong Road, Shanghai, China.
 * All rights reserved.
 *
 * "[Description of code or deliverable as appropriate] is the copyrighted,
 * proprietary property of State Street Bank and Trust Company and its
 * subsidiaries and affiliates which retain all right, title and interest
 * therein."
 *
 * Revision History
 *
 * Date          Programmer          Notes
 * -----
 * 2007-8-24    Mike Gu          initial
 */
package demo;

import imix.DataDictionary;
import imix.Field;
import imix.FieldMap;
import imix.FieldNotFound;
import imix.FieldType;
import imix.Group;
import imix.IncorrectTagValue;
import imix.Message;
import imix.StringField;
import imix.UnsupportedMessageType;
import imix.client.core.ImixSession;
import imix.client.core.Listener;
import imix.client.core.MessageCracker;
import imix.field.DBSQLStatement;
import imix.field.DataBaseName;
import imix.field.DeliverToCompID;
import imix.field.MsgType;
import imix.field.QueryDBSchemaName;
import imix.field.QueryDBTableName;
import imix.field.QueryDataBaseName;
import imix.field.QueryPageSize;

```

```

import imix.field.QueryRequestID;
import imix.field.QueryStartNumber;
import imix.field.QueryType;
import imix.imix10.ExecutionReport;
import imix.imix10.QueryReject;
import imix.imix10.QueryRequest;
import imix.imix10.QueryResult;
import imix.imix10.QueryResult.NoDBNames;

import java.util.Iterator;

public class ClientListener extends MessageCracker implements Listener {

    public void fromApp(Message message, ImixSession imixSession) throws
UnsupportedMessageType, FieldNotFound, IncorrectTagValue {
        // System.out.println("=====fromApp()=====");
        // System.out.println("imixSession:" + imixSession);
        // messageCrack(message);
        // System.out.println("=====");
    }

    public void onLogon(ImixSession imixSession) {
        System.out.println("=====onLogon()=====");
        System.out.println("imixSession:" + imixSession);
        System.out.println("=====");
    }

    public void onLogout(ImixSession imixSession) {
        System.out.println("=====onLogout()=====");
        System.out.println("imixSession:" + imixSession);
        System.out.println("=====");
    }

    public void toApp(Message message, ImixSession imixSession) {
        // System.out.println("=====toApp()=====");
        // System.out.println("imixSession:" + imixSession);
        // System.out.println("=====");
    }

    public void fromAdmin(Message message, ImixSession imixSession) {
        // System.out.println("=====fromAdmin()=====");
        // System.out.println("imixSession:" + imixSession);
        // System.out.println("=====");
    }

```

```

}
```

```

public void onError(ImixSession imixSession, int type) {
    System.out.println("=====onError()=====");
    if (Listener.CONNECTION_FAILURE == type) {
        System.out.println("connection failure");
        System.out.println("=====");
    }
}
}
```

```

public void onMessage(QueryReject queryReject) throws FieldNotFound,
UnsupportedMessageType, IncorrectTagValue {
    // print message received
    DataDictionary dd =
ImixSession.LookupIMIXSession(queryReject).getDataDictionary();
    String msgType = queryReject.getHeader().getString(MsgType.FIELD);
    System.out.println("\r\n\r\n");//
    printFieldMap("", dd, msgType, queryReject);
    System.out.println("\r\n\r\n");//

    // get message received
    QueryRequestID queryRequestID = new QueryRequestID();
    QueryType queryType = new QueryType();
    queryReject.get(queryRequestID);
    queryReject.get(queryType);

    QueryRequest queryRequest = new QueryRequest();
    queryRequest.setString(queryRequestID.getField(), idPlusOne(queryRequestID));
    queryRequest.set(queryType);
    queryRequest.set(new QueryDataBaseName("D*"));

    /**
     * set the DeliverToCompID
     */
    queryRequest.getHeader().setString(DeliverToCompID.FIELD, "CFETS");
    ImixSession.LookupIMIXSession(queryReject).send(queryRequest);
}
}
```

```

public void onMessage(QueryResult queryResult) throws FieldNotFound,
UnsupportedMessageType, IncorrectTagValue {
    // print message received
    DataDictionary dd =
ImixSession.LookupIMIXSession(queryResult).getDataDictionary();
}
```

```

String msgType = queryResult.getHeader().getString(MsgType.FIELD);
System.out.println("\r\n\r\n");//
printFieldMap("", dd, msgType, queryResult);
System.out.println("\r\n\r\n");//

// get message received
Message msg = new Message();
QueryType queryType = new QueryType();
queryResult.get(queryType);

if (queryType.getValue() == 21) {
    msg = queryRequest_QueryType_22(queryResult);
} else if (queryType.getValue() == 22) {
    msg = queryRequest_QueryType_23(queryResult);
} else if (queryType.getValue() == 23) {
    msg = queryRequest_QueryType_25(queryResult);
} else if (queryType.getValue() == 25) {
    msg = queryRequest_QueryType_30(queryResult);
} else {
    msg = null;
}

if (msg != null) {
    msg.getHeader().setString(DeliverToCompID.FIELD, "CFETS");
    ImixSession.LookupIMIXSession(queryResult).send(msg);
}

}

public static QueryRequest queryRequest_QueryType_22(QueryResult queryResult)
throws FieldNotFound {
    // get message received
    QueryRequestID queryRequestID = new QueryRequestID();
    NoDBNames noDBNames = new NoDBNames();
    DataBaseName dataBaseName = new DataBaseName();
    queryResult.get(queryRequestID);
    queryResult.getGroup(1, noDBNames);
    noDBNames.get(dataBaseName);

    QueryRequest queryRequest = new QueryRequest();
    queryRequest.setString(queryRequestID.getField(), idPlusOne(queryRequestID));
    queryRequest.set(new QueryType(22));
    queryRequest.set(new QueryDataBaseName(dataBaseName.getValue()));
}

```

```

        queryRequest.set(new QueryDBSchemaName("D*"));

        return queryRequest;
    }

    public static QueryRequest queryRequest_QueryType_23(QueryResult queryResult)
throws FieldNotFound {
        // get message received
        QueryRequestID queryRequestID = new QueryRequestID();
        QueryDataBaseName queryDataBaseName = new QueryDataBaseName();
        queryResult.get(queryRequestID);
        queryResult.get(queryDataBaseName);

        QueryRequest queryRequest = new QueryRequest();
        queryRequest.setString(queryRequestID.getField(), idPlusOne(queryRequestID));
        queryRequest.set(new QueryType(23));
        queryRequest.set(queryDataBaseName);

        return queryRequest;
    }

    public static QueryRequest queryRequest_QueryType_25(QueryResult queryResult)
throws FieldNotFound {
        // get message received
        QueryRequestID queryRequestID = new QueryRequestID();
        QueryDataBaseName queryDataBaseName = new QueryDataBaseName();
        queryResult.get(queryRequestID);
        queryResult.get(queryDataBaseName);

        QueryRequest queryRequest = new QueryRequest();
        queryRequest.setString(queryRequestID.getField(), idPlusOne(queryRequestID));
        queryRequest.set(new QueryType(25));
        queryRequest.set(queryDataBaseName);
        queryRequest.set(new QueryDBSchemaName("FC"));
        queryRequest.set(new QueryDBTableName("u*"));

        return queryRequest;
    }

    public static QueryRequest queryRequest_QueryType_30(QueryResult queryResult)
throws FieldNotFound {
        // get message received
        QueryRequestID queryRequestID = new QueryRequestID();

```



```

QueryDataBaseName queryDataBaseName = new QueryDataBaseName();
queryResult.get(queryRequestID);
queryResult.get(queryDataBaseName);

QueryRequest queryRequest = new QueryRequest();
queryRequest.setString(queryRequestID.getField(), idPlusOne(queryRequestID));
queryRequest.set(new QueryType(30));
queryRequest.set(queryDataBaseName);
queryRequest.set(new DBSQLStatement("select * from user"));
queryRequest.set(new QueryPageSize(5));
queryRequest.set(new QueryStartNumber(10));

return queryRequest;
}

```

```

public void onMessage(ExecutionReport executionReport) throws FieldNotFound,
UnsupportedMessageType, IncorrectTagValue {

```

```

// get message received
// ExecID execID = new ExecID();
// TradeDate tradeDate = new TradeDate();
// TotNumReports totNumReports = new TotNumReports();
// LastRptRequested lastRptRequested = new LastRptRequested();
// QueryRequestID queryRequestID = new QueryRequestID();
// QueryPageNumber queryPageNumber = new QueryPageNumber();
// NoPartyIDs noPartyIDs = new NoPartyIDs();
// PartyID partyID = new PartyID();
// PartyRole partyRole = new PartyRole();
// NoPartySubIDs noPartySubIDs = new NoPartySubIDs();
// PartySubID partySubID = new PartySubID();
// PartySubIDType partySubIDType = new PartySubIDType();
//
// SimpleDateFormat datafmt = new SimpleDateFormat("yyyyMMdd");
// try{
// executionReport.set(new TradeDate(datafmt.parse("20071123")));
// }catch(ParseException e){
//
// }
//
// executionReport.get(execID);
// executionReport.get(tradeDate);
// executionReport.get(totNumReports);
// executionReport.get(lastRptRequested);
// executionReport.get(queryRequestID);

```

```

// executionReport.get(queryPageNumber);
// System.out.println(execID.getValue());
// System.out.println(tradeDate.getValue());
// System.out.println(totNumReports.getValue());
// System.out.println(lastRptRequested.getValue());
// System.out.println(queryRequestID.getValue());
// System.out.println(queryPageNumber.getValue());
//
// System.out.println("-----");
// System.out.println(executionReport.get(new
// imix.field.NoPartyIDs()).getValue());
// System.out.println(" -----");
//
// for(int i = 1; i <= executionReport.get(new
// imix.field.NoPartyIDs()).getValue(); i++)
// {
// executionReport.getGroup(i, noPartyIDs);
// noPartyIDs.get(partyID);
// noPartyIDs.get(partyRole);
// System.out.println(" -> " + partyID.getValue());
// System.out.println(" -> " + partyRole.getValue());
//
// System.out.println(" -----");
// System.out.println(" -> " + noPartyIDs.get(new
// imix.field.NoPartySubIDs()).getValue());
// System.out.println(" -----");
//
// for(int j = 1; j <= noPartyIDs.get(new
// imix.field.NoPartySubIDs()).getValue(); j++)
// {
// noPartyIDs.getGroup(j, noPartySubIDs);
// noPartySubIDs.get(partySubID);
// noPartySubIDs.get(partySubIDType);
// System.out.println(" -> -> " + partySubID.getValue());
// System.out.println(" -> -> " + partySubIDType.getValue());
// System.out.println(" -----");
// }
//
// System.out.println(" -----");
// }
//
// System.out.println("-----");

```

```

// print message received
DataDictionary dd =
ImixSession.LookUpIMIXSession(executionReport).getDataDictionary();

String msgType = executionReport.getHeader().getString(MsgType.FIELD);
printFieldMap("", dd, msgType, executionReport.getHeader());
printFieldMap("", dd, msgType, executionReport);
printFieldMap("", dd, msgType, executionReport.getTrailer());
}

private static void printFieldMap(String prefix, DataDictionary dd, String msgType,
FieldMap fieldMap) throws FieldNotFound {
    Iterator fieldIterator = fieldMap.iterator();
    while (fieldIterator.hasNext()) {
        Field field = (Field) fieldIterator.next();
        if (!isGroupCountField(dd, field)) {
            String value = fieldMap.getString(field.getTag());
            if (dd.hasFieldValue(field.getTag())) {
                value = dd.getValueName(field.getTag(),
fieldMap.getString(field.getTag())) + " (" + value + ")";
            }
            System.out.println(prefix + dd.getFieldName(field.getTag()) + ": " +
value);
        }
    }
}

Iterator groupsKeys = fieldMap.groupKeyIterator();
while (groupsKeys.hasNext()) {
    int groupCountTag = ((Integer) groupsKeys.next()).intValue();
    System.out.println(prefix + dd.getFieldName(groupCountTag) + ": count = " +
fieldMap.getInt(groupCountTag));
    Group g = new Group(groupCountTag, 0);
    int i = 1;
    while (fieldMap.hasGroup(i, groupCountTag)) {
        if (i > 1) {
            System.out.println(prefix + " ----");
        }
        fieldMap.getGroup(i, g);
        printFieldMap(prefix + " ", dd, msgType, g);
        i++;
    }
}
}
}

```

```

private static boolean isGroupCountField(DataDictionary dd, Field field) {
    return dd.getFieldTypeEnum(field.getTag()) == FieldType.NumInGroup;
}

private static String idPlusOne(StringField field) {
    String str = field.getValue();
    char[] id = new char[str.length()];
    str.getChars(0, str.length(), id, 0);

    str = new String(plusOne(id, str.length() - 1));
    return str;
}

private static char[] plusOne(char[] id, int address) {
    char a = id[address];
    if (a < '9' && a >= '0') {
        id[address] = (char) (a + 1);
    } else if (a == '9') {
        id[address] = '0';
        if (address > 0) {
            plusOne(id, address - 1);
        }
    }
    return id;
}
}
}

```

——Server 部分

示例3: Client 应用类, 用于创建 Client 端应用、管理会话生命周期以及发送 IMIX 报文。

```

package server;

import java.io.IOException;

import imix.core.api.IMIXApplication;

public class Server {

    /**
     * @param args
     * @throws IOException
     */
    public static void main(String[] args) throws IOException {
        IMIXApplication app = new IMIXApplication("cfg/server.cfg");
    }
}

```

```

    if(!app.init()){
        System.out.println("Init failed!");
        return;
    }

    app.setUsrListener(new ServerUserListenerImpl());
    app.setMsgRcvListener(new MessageReceiveListenerImpl());
    app.setMsgSendListener(new MessageSendListenerImpl());
    app.setEventListener(new EventListenerImpl());

    app.start();

    System.in.read();

    app.stop();
}
}

```

示例4: 会话验证 Listener 回调方法实现类, 用于处理会话登陆。

```

package server;

import imix.FieldNotFound;
import imix.IncorrectDataFormat;
import imix.IncorrectTagValue;
import imix.Message;
import imix.SessionID;
import imix.core.api.UserListener;
import imix.engine.core.RejectLogon;
import imix.engine.core.Session;
import imix.field.Password;
import imix.field.Username;

public class ServerUserListenerImpl implements UserListener {

    public void verifyLogon(Message message, SessionID sessionId)
        throws FieldNotFound, IncorrectDataFormat, IncorrectTagValue,
        RejectLogon {
        //server need to verify username and password
        if(message.getString(Username.FIELD).contains("reject")){
            throw new RejectLogon("contains reject");
        }else{
            System.out.println("user:" + message.getString(Username.FIELD) + " will pass

```

```

logon!");
    }
    Session session = Session.LookupSession(sessionId);
    //session.send(message);
}

public void fillLogon(Message message, SessionID sessionId) {
    //server do not need to fill username and password
    //ignore
}
}

```

示例5: 报文接收 Listener 回调方法实现类, 用于接收到的 IMIX 报文。

```

package server;

import java.io.IOException;

import imix.FieldNotFound;
import imix.IncorrectDataFormat;
import imix.IncorrectTagValue;
import imix.Message;
import imix.SessionID;
import imix.UnsupportedMessageType;
import imix.core.api.MessageReceiveListener;
import imix.engine.core.RejectLogon;
import imix.imix10.ExecutionReport;
import imix.imix10.HeartBeat;
import imix.imix10.MessageCracker;

public class MessageReceiveListenerImpl extends MessageCracker implements
    MessageReceiveListener {

    @Override
    public void onMessage(HeartBeat message) throws FieldNotFound,
        UnsupportedMessageType, IncorrectTagValue {

    }

    @Override
    public void onMessage(ExecutionReport message) throws FieldNotFound,
        UnsupportedMessageType, IncorrectTagValue {

    }
}

```

```

public void fromApp(Message message, SessionID sessionId)
    throws FieldNotFound, IncorrectDataFormat, IncorrectTagValue,
        UnsupportedMessageType, IOException {
    System.out.println("fromApp(), message: " + message + " from:"
        + sessionId);

    // fire the MessageCracker dispatcher here!
    crack(message);
}

public void fromAdmin(Message message, SessionID sessionId)
    throws FieldNotFound, IncorrectDataFormat, IncorrectTagValue,
        RejectLogon {
    System.out.println("fromAdmin(), message: " + message + " from:"
        + sessionId);

    // fire the MessageCracker dispatcher here!

    try {
        crack(message);
    } catch (UnsupportedMessageType e) {
        e.printStackTrace();
    }
}
}

```

示例6: 报文发送 Listener 回调方法实现类, 用于处理发送的 IMIX 报文。

```

package server;

import imix.Message;
import imix.SessionID;
import imix.core.api.MessageSendListener;
import imix.engine.core.DoNotSend;

public class MessageSendListenerImpl implements MessageSendListener {

    public void toApp(Message message, SessionID sessionId) throws DoNotSend {
        // TODO Auto-generated method stub
    }

    public void toAdmin(Message message, SessionID sessionId) {

```

```

        // TODO Auto-generated method stub

    }

}

```

示例7：事件 Listener 回调方法实现类，用于处理会话事件。

```

package server;

import imix.SessionID;
import imix.core.api.EventListener;

public class EventListenerImpl implements EventListener {

    public void onLogout(SessionID sessionId) {
        System.out.println("onLogout(): " + sessionId);
    }

    public void onLogon(SessionID sessionId) {
        System.out.println("onLogon(): " + sessionId);
    }

    public void onCreate(SessionID sessionId) {
        System.out.println("onCreate(): " + sessionId);
    }

}

```

7 IMIX 报文接口规范

IMIX报文是银行间市场业务数据交换的基本单位。IMIX报文接口提供构建银行应用系统进行业务数据解析和封装必要的接口与方法。本章定义了接口、方法、函数、参数及使用规范。

7.1 报文格式简介

IMIX 报文分为报文头 (Header)、报文体 (Body)、报文尾 (Trailer) 三部分，报文头 (Header) 主要承载报文传输协议本身所需要的一些信息；报文体 (Body) 主要承载报文内容本身；报文尾 (Trailer) 主要负责检验等工作。

为保证报文被正确传输，域“8、9、10、34、35、49、52、56”在“IMIX1.0”协议中为必需域，在报文头 (Header)、报文尾 (Trailer) 中使用。

- 8 BeginString
- 9 BodyLength
- 35 MsgType
- 49 SenderCompID
- 56 TargetCompID

- 34 MsgSeqNum
- 52 SendingTime
- 10 CheckSum

域“43、50、57、89、90、91、93、97、115、116、122、128、129、142、143、144、145、212、213、347、369、627、628、629、630”在 IMIX 协议中作为可选域，在报文头(Header)、报文尾(Trailer)中使用，来保证报文被正确、安全地在多方之间传输。

报文头(Header)中的MsgType域(域 35)被用来设定报文类型；其中，“0”、“1”、“2”、“3”、“4”、“5”、“A”七种报文类型被用来作为 Admin报文，以保证报文通讯。其他报文类型均为App报文。

7.2 报文接口定义

本条将对描述IMIX报文的主要类及接口进行定义。
IMIX报文接口整体类图如图10。



图10 IMIX 报文接口类图

IMIX报文接口主要包含以下Interface及Class:

——**Class 名称:** `public class imix.Field`

IMIX报文域基类，用于描述业务内容的最小单位。所有业务域均继承自此类。其主要公共方法如表12。

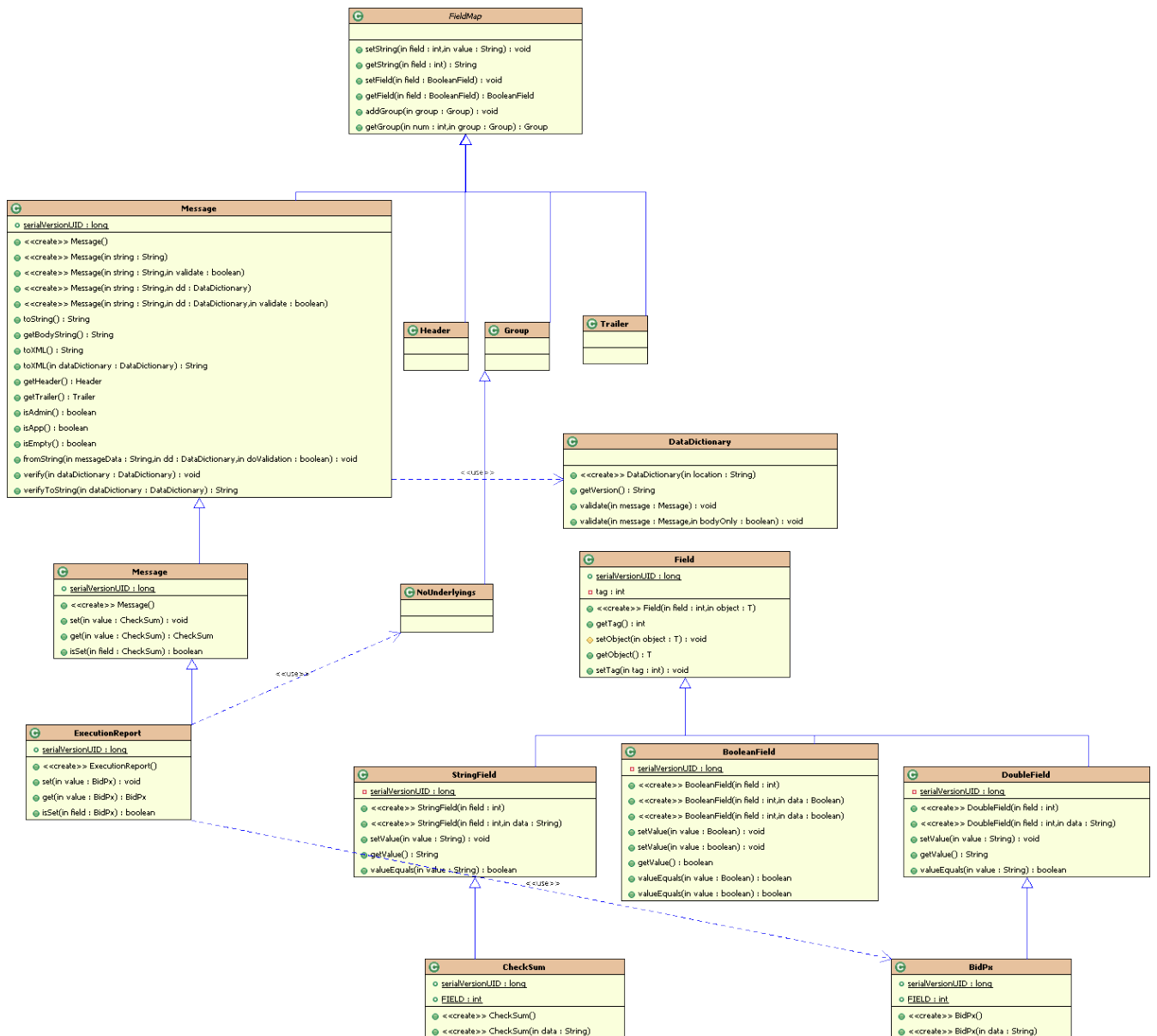
表12 Field 类公共方法

构造函数		
<code>public Field</code>	<code>Field(int tag, T object);</code>	构造函数。
域内容接口		
<code>public int</code>	<code>getTag();</code>	获取域号。
<code>public void</code>	<code>setTag(int tag);</code>	对域号赋值。
<code>public T</code>	<code>getObject();</code>	获取域值对象。
<code>public void</code>	<code>setObject(T object);</code>	域赋值。

Class Field类方法定义如下:

a) Field 方法

方法名称: Field

返回类型: Field

方法说明: 报文域构造函数，初始化域标号及域值对象。

异常申明: N/A

参数定义:

- 1) `int tag` 报文域标号。
- 2) `T object` 域值对象。

b) getTag 方法

方法名称: getTag

返回类型: `int`

方法说明: 获取域标号。

异常申明: N/A

参数定义: N/A

c) setTag 方法

方法名称: setTag

返回类型: `void`

方法说明: 对域标号赋值。

异常申明: N/A

参数定义:

- 1) `int tag` 报文域标号。

d) getObject 方法

方法名称: getObject

返回类型: `T`

方法说明: 获取域值对象。

异常申明: N/A

参数定义: N/A

e) setObject 方法
 方法名称: setObject
 返回类型: void
 方法说明: 对域赋值。
 异常申明: N/A
 参数定义:

1) T object 域值对象。

——**Class 名称:** public class imix.BooleanField 等

IMIX报文接口定义了一组IMIX基本类型报文域基类,用于描述各种类型的报文域值。此处以布尔型基类为例说明,所有的域类型可查询附录A。其主要公共方法如表13。

表13 布尔型基类公共方法

构造函数		
public BooleanField	BooleanField(int tag);	构造函数。
public BooleanField	BooleanField(int tag, boolean data);	构造函数。
public BooleanField	BooleanField(int tag, Boolean data);	构造函数。
域内容接口		
public boolean	getValue();	获取域值。
public void	setValue(boolean value);	对域赋值。
public void	setValue(Boolean value);	对域赋值。
public boolean	valueEquals(boolean value);	比较域值。
public boolean	valueEquals(Boolean value);	比较域值。

Class BooleanField类方法定义如下:

a) BooleanField 方法

方法名称: BooleanField

返回类型: BooleanField

方法说明: 报文域构造函数,初始化域标号,默认域值初始为false。

异常申明: N/A

参数定义:

1) int tag 报文域标号。

b) BooleanField 方法

方法名称: BooleanField

返回类型: BooleanField

方法说明: 报文域构造函数,初始化域标号及域值。

异常申明: N/A

参数定义:

1) int tag 报文域标号。

2) boolean data 报文域值。

c) BooleanField 方法

方法名称: BooleanField

返回类型: BooleanField

方法说明：报文域构造函数，初始化域标号及域值。

异常申明：N/A

参数定义：

- 1) int tag 报文域标号。
- 2) Boolean data 报文域值。

d) getValue 方法

方法名称：getValue

返回类型：boolean

方法说明：获取域值。

异常申明：N/A

参数定义：N/A

e) setValue 方法

方法名称：setValue

返回类型：void

方法说明：对域赋值。

异常申明：N/A

参数定义：

- 1) boolean value 域值。

f) setValue 方法

方法名称：setValue

返回类型：void

方法说明：对域赋值。

异常申明：N/A

参数定义：

- 1) Boolean value 域值。

g) valueEquals 方法

方法名称：valueEquals

返回类型：boolean

方法说明：比较域值，如相同返回true，否则返回false。

异常申明：N/A

参数定义：

- 1) Boolean value 域值。

h) valueEquals 方法

方法名称：valueEquals

返回类型：boolean

方法说明：比较域值，如相同返回true，否则返回false。

异常申明：N/A

参数定义：

- 1) boolean value 域值。

——**Class 名称：**public class imix.field.BidPx 等

imix.field包下定义了一组IMIX业务报文域，继承自相应类型域基类。此处以imix.field.BidPx为例说明，所有的域类可查询附录A。其主要公共方法如表14。

表14 BidPx 类公共方法

构造函数		
public BidPx	BidPx ();	构造函数。
public BidPx	BidPx (String data);	构造函数。

Class BidPx类方法定义如下:

a) BidPx 方法

方法名称: BidPx

返回类型: BidPx

方法说明: 报文域构造函数, 域标号根据域类型内置, 无需构造。

异常申明: N/A

参数定义: N/A

b) BidPx 方法

方法名称: BidPx

返回类型: BidPx

方法说明: 报文域构造函数, 初始化域值。

异常申明: N/A

参数定义:

1) String data 报文域值。

——Class 名称: **public class** imix.FieldMap

描述IMIX域集合基类。所有IMIX报文类均继承此基类。通过定义一系列getField方法及setField方法用于域值获取及赋值, 同时也提供更为基础的通过域标号获取及对域赋值的方法。其主要公共方法如表15。

表15 域集合类公共方法

报文域接口		
public Field<?>	getField(Field<?> field) throws FieldNotFound;	获取域。
public void	setField(Field<?> field);	对域赋值。
public String	getString(int field) throws FieldNotFound;	以 String 形式获取域。
public void	setString(int field, String value);	以 String 形式对域赋值。
报文重复组接口		
public Group	getGroup(int num, Group group) throws FieldNotFound;	获取重复组内容。
public void	addGroup(Group group);	添加重复组内容。

Class FieldMap类方法定义如下:

a) getField 方法

方法名称: getField

返回类型: Field<?> 一组域类型

方法说明: 获取域, 对传入域对象赋值。注: 为值拷贝而非引用赋值。

异常申明:

- 1) FieldNotFound 域未发现异常。

参数定义:

- 1) Field<?> field 不同的继承自 Field 类的基础类型, 如 BooleanField。

- b) setField 方法

方法名称: setField

返回类型: void

方法说明: 域赋值, 根据传入参数域对象进行赋值。注: 为值拷贝而非引用赋值。

异常申明: N/A

参数定义:

- 1) Field<?> field 不同的继承自 Field 类的基础类型, 如 BooleanField。

- c) getString 方法

方法名称: getString

返回类型: String

方法说明: 以string形式获取域。

异常申明:

- 1) FieldNotFound 域未发现异常。

参数定义:

- 2) int field 域号。

- d) setString 方法

方法名称: setString

返回类型: void

方法说明: 域赋值, 根据传入域值及域号进行赋值。

异常申明: N/A

参数定义:

- 1) int field 域号。
- 2) String value 域值。

- e) getGroup 方法

方法名称: getGroup

返回类型: imix.Group

方法说明: 获取重复组内容, 通过传入重复组下标及重复组对象, 对重复组对象进行值拷贝。

异常申明:

- 1) FieldNotFound 域未发现异常。

参数定义:

- 1) int num 重复组下标, 从 1 开始。
- 2) imix.Group group 重复组对。

- f) addGroup 方法

方法名称: addGroup

返回类型: void

方法说明: 重复组内容赋值, 根据传入重复组, 对其内容添加值域集合中。

异常申明: N/A

参数定义:

- 1) imix.Group group 重复组对。

——Class 名称: `public class imix.Message`

IMIX报文基类。所有业务报文类均继承此基类。其主要公共方法如表16。

表16 报文基类公共方法

构造函数		
public Message	Message();	构造函数。
public Message	Message(String string) throws InvalidMessage;	构造函数，通过报文文本构造报文对象。
public Message	Message(String string, boolean validate) throws InvalidMessage;	构造函数，通过报文文本构造报文对象，并设置是否检查校验码。
public Message	Message(String string, DataDictionary dd) throws InvalidMessage;	构造函数，通过报文文本构造报文对象，并通过数据字典验证。
public Message	Message(String string, DataDictionary dd, boolean validate) throws InvalidMessage;	构造函数，通过报文文本构造报文对象，并通过数据字典验证，同时设置是否检查校验码。
public void	fromString(String messageData, DataDictionary dd, boolean doValidate) throws InvalidMessage;	初始化函数，通过报文文本初始化报文对象，并通过数据字典验证，同时设置是否检查校验码。
报文内容获取接口		
public String	getBodyString();	获取报文体文本。
public final Header	getHeader();	获取报文头结构体。
public final Trailer	getTrailer();	获取报文末结构图。
报文内容验证接口		
public void	verify(DataDictionary dd) throws InvalidMessage;	根据数据字典验证报文内容。
public String	verifyToString(DataDictionary dd) throws InvalidMessage;	根据数据字典验证报文内容后返回报文文本。
public Boolean	isAdmin();	是否是管理类报文。
public Boolean	isApp();	是否是业务类报文。
public Boolean	isEmpty();	报文是否为空。
报文内容转换接口		
public String	toString();	返回报文内容文本。
public String	toXML();	返回 XML 格式报文内容文本。
public String	toXML(DataDictionary dataDictionary);	根据数据字典验证报文内容后返回 XML。

Class Message类方法定义如下：

a) Message 方法

方法名称：Message

返回类型：Message

方法说明：报文构造函数。

异常申明：N/A

参数定义：N/A

b) Message 方法

方法名称: Message

返回类型: Message

方法说明: 报文构造函数, 通过报文文本构造报文对象。

异常申明:

- 1) imix.InvalidMessage 非法报文异常。

参数定义:

- 1) String string 报文内容文本。

c) Message 方法

方法名称: Message

返回类型: Message

方法说明: 报文构造函数, 通过报文文本构造报文对象, 并设置是否检查校验码。

异常申明:

- 1) imix.InvalidMessage 非法报文异常。

参数定义:

- 1) String string 报文内容文本。
- 2) boolean validate 是否验证校验码。

d) Message 方法

方法名称: Message

返回类型: Message

方法说明: 报文构造函数, 通过报文文本构造报文对象, 并设置是否检查校验码。

异常申明:

- 1) imix.InvalidMessage 非法报文异常。

参数定义:

- 1) String string 报文内容文本。
- 2) imix.DataDictionary dd IMIX 数据字典。

e) Message 方法

方法名称: Message

返回类型: Message

方法说明: 报文构造函数, 通过报文文本构造报文对象, 并设置是否检查校验码。

异常申明:

- 1) imix.InvalidMessage 非法报文异常。

参数定义:

- 1) String string 报文内容文本。
- 2) imix.DataDictionary dd IMIX 数据字典。
- 3) boolean valiate 是否验证校验码。

f) fromString 方法

方法名称: fromString

返回类型: void

方法说明: 初始化报文内容。

异常申明:

- 1) imix.InvalidMessage 非法报文异常。

参数定义:

- 1) String messageData 报文内容文本。

2) `imix.DataDictionary dd` IMIX 数据字典。

3) `boolean valiate` 是否验证校验码。

g) `getBodyString` 方法

方法名称: `getBodyString`

返回类型: `String`

方法说明: 获取报文体文本内容 (除头尾结构)。

异常申明: N/A

参数定义: N/A

h) `getHeader` 方法

方法名称: `getHeader`

返回类型: `imix.Message.Header`

方法说明: 获取报文头结构。

异常申明: N/A

参数定义: N/A

i) `getTrailer` 方法

方法名称: `getTrailer`

返回类型: `imix.Message.Trailer`

方法说明: 获取报文尾结构。

异常申明: N/A

参数定义: N/A

j) `verify` 方法

方法名称: `verify`

返回类型: `void`

方法说明: 根据数据字典验证报文。

异常申明:

1) `imix.InvalidMessage` 非法报文异常。

参数定义:

1) `imix.DataDictionary dd` 数据字典。

k) `verifyToString` 方法

方法名称: `verifyToString`

返回类型: `String`

方法说明: 根据数据字典验证报文并返回报文内容文本。

异常申明:

1) `imix.InvalidMessage` 非法报文异常。

参数定义:

1) `imix.DataDictionary dd` 数据字典。

l) `isAdmin` 方法

方法名称: `isAdmin`

返回类型: `boolean`

方法说明: 是否为管理类报文类型。

异常申明: N/A

参数定义: N/A

m) `isApp` 方法

方法名称: isApp
 返回类型: boolean
 方法说明: 是否为业务类报文类型。
 异常申明: N/A
 参数定义: N/A

n) isEmpty 方法
 方法名称: isEmpty
 返回类型: boolean
 方法说明: 报文内容是否为空。
 异常申明: N/A
 参数定义: N/A

o) toString 方法
 方法名称: toString
 返回类型: String
 方法说明: 返回报文内容文本。
 异常申明: N/A
 参数定义: N/A

p) toXML 方法
 方法名称: toXML
 返回类型: String
 方法说明: 以XML形式返回报文内容文本。
 异常申明: N/A
 参数定义: N/A

q) toXML 方法
 方法名称: toXML
 返回类型: String
 方法说明: 根据数据字典验证并以XML形式返回报文内容文本。
 异常申明: N/A
 参数定义:

1) imix.DataDictionary dd 数据字典。

——Class 名称: **public class** imix.Message.Header
 IMIX报文头类。

——Class 名称: **public class** imix.Message.Trailer
 IMIX报文头类。

——Class 名称: **public class** imix.imix10.Message

IMIX 1.0版报文基类, 继承自imix.Message并实现必要的方法支持IMIX1.0协议报文。此类定义了同名但参数及返回类型各不相同的三组方法用于报文内数据获取和设置: get方法组、set方法组、isSet方法组。其主要公共方法如表17。

表17 IMIX1.0 报文基类公共方法

构造函数		
public Message	Message();	构造函数。

报文内容接口		
public Field<?>	get(Field<?> field) throws FieldNotFound;	get 方法组，用于获取报文体内数据。
public void	set(Field<?> field);	set 方法组，用于设置报文内容。
public Boolean	isSet(Field<?> field);	判断域是否被赋值。

Class IMIX1.0 Message类方法定义如下：

a) Message 方法

方法名称：Message

返回类型：Message

方法说明：报文构造函数。

异常申明：N/A

参数定义：N/A

b) get 方法

方法名称：get

返回类型：Field<?> 一组域类型

方法说明：获取域，对传入域对象赋值。注：为值拷贝而非引用赋值。

异常申明：

- 1) FieldNotFound 域未发现异常。

参数定义：

- 1) Field<?> field 不同的继承自 Field 类的业务类型，如 BidPx。

c) set 方法

方法名称：set

返回类型：void

方法说明：域赋值，根据传入参数域对象进行赋值。注：为值拷贝而非引用赋值。

异常申明：N/A

参数定义：

- 1) Field<?> field 不同的继承自 Field 类的业务类型，如 BidPx。

d) isSet 方法

方法名称：isSet

返回类型：boolean

方法说明：判断此域是否被赋值。

异常申明：N/A

参数定义：

- 1) Field<?> field 不同的继承自 Field 类的业务类型，如 BidPx。

——**Class 名称：**public class imix.imix10.ExecutionReport 等

在imix.imix10包内定义了各类业务报文类，继承自imix.imix10.Message并实现必要的方法支持各类业务。此种类定义了同名但参数及返回类型各不相同的三组方法用于报文内数据获取和设置：get方法组、set方法组、isSet方法组，详细报文类型参见附录A。以下以imix.imix10.ExecutionReport类为例说明。其主要公共方法如表18。

表18 ExecutionReport 报文类公共方法

构造函数		
public ExecutionReport	ExecutionReport();	构造函数。
报文内容接口		

public Field<?>	get(Field<?> field) throws FieldNotFound;	get 方法组, 用于获取报文体内数据。
public void	set(Field<?> field);	set 方法组, 用于设置报文内容。
public Boolean	isSet(Field<?> field);	判断域是否被赋值。

Class IMIX1.0 ExecutionReport类方法定义如下:

a) ExecutionReport 方法

方法名称: ExecutionReport

返回类型: ExecutionReport

方法说明: 报文构造函数。

异常申明: N/A

参数定义: N/A

b) get 方法

方法名称: get

返回类型: Field<?> 一组域类型

方法说明: 获取域, 对传入域对象赋值。注: 为值拷贝而非引用赋值。

异常申明:

- 1) FieldNotFound 域未发现异常。

参数定义:

- 1) Field<?> field 不同的继承自 Field 类的业务类型, 如 BidPx。

c) set 方法

方法名称: set

返回类型: void

方法说明: 域赋值, 根据传入参数域对象进行赋值。注: 为值拷贝而非引用赋值。

异常申明: N/A

参数定义:

- 1) Field<?> field 不同的继承自 Field 类的业务类型, 如 BidPx。

d) isSet 方法

方法名称: isSet

返回类型: boolean

方法说明: 判断此域是否被赋值。

异常申明: N/A

参数定义:

- 1) Field<?> field 不同的继承自 Field 类的业务类型, 如 BidPx。

——**Class 名称:** public class imix.Group

IMIX重复组基类。对报文内重复出现的域聚合为重复组对象, 用于描述重复出现的域集合。

——**Class 名称:** public class imix.imix10.ExecutionReport.NoUnderlyings 等

IMIX重复组业务类, 作为静态类定义在不同的业务报文内, 对其报文内重复组域集合进行定义。其重要公告方法如表19。

表19 NoUnderlyings 重复组域集合公共方法

构造函数		
public NoUnderlyings	NoUnderlyings();	构造函数。
报文内容接口		

public Field<?>	get(Field<?> field) throws FieldNotFound;	get方法组，用于获取报文体内数据。
public void	set(Field<?> field);	set方法组，用于设置报文内容。
public boolean	isSet(Field<?> field);	判断域是否被赋值。

Class NoUnderlyings类方法定义如下：

a) NoUnderlyings 方法

方法名称：NoUnderlyings

返回类型：NoUnderlyings

方法说明：报文构造函数。

异常申明：N/A

参数定义：N/A

b) get 方法

方法名称：get

返回类型：Field<?> 一组域类型

方法说明：获取域，对传入域对象赋值。注：为值拷贝而非引用赋值。

异常申明：

1) FieldNotFound 域未发现异常。

参数定义：

1) Field<?> field 不同的继承自 Field 类的业务类型，如 BidPx。

c) set 方法

方法名称：set

返回类型：void

方法说明：域赋值，根据传入参数域对象进行赋值。注：为值拷贝而非引用赋值。

异常申明：N/A

参数定义：

1) Field<?> field 不同的继承自 Field 类的业务类型，如 BidPx。

d) isSet 方法

方法名称：isSet

返回类型：boolean

方法说明：判断此域是否被赋值。

异常申明：N/A

参数定义：

1) Field<?> field 不同的继承自 Field 类的业务类型，如 BidPx。

——**Class 名称：**public class imix.DataDictionary

IMIX数据字典类。根据不同协议版本的元数据模板初始化，用于验证报文结构、报文内容、域格式、域取值等。其主要公共方法如表20。

表20 IMIX 数据字典类公共方法

构造函数		
public DataDictionary	DataDictionary(String location);	构造函数，通过元数据模板路径初始化。
验证接口		
public String	getVersion();	获取协议版本号。
public void	validate(Message message) throws	根据模板验证报文。

	IncorrectTagValue, FieldNotFound, IncorrectDataFormat;	
public void	validate(Message message, boolean bodyOnly) throws IncorrectTagValue, FieldNotFound, IncorrectDataFormat, UnsupportedVersion;	根据模板验证报文,并设置是否值验证报文体而忽略头尾。

Class DataDictionary类方法定义如下:

a) DataDictionary 方法

方法名称: DataDictionary

返回类型: DataDictionary

方法说明: 报文构造函数。

异常申明: N/A

参数定义:

- 1) String location 协议元数据模板路径。

b) getVersion 方法

方法名称: getVersion

返回类型: String

方法说明: 获取协议版本号

异常申明: N/A

参数定义: N/A

c) validate 方法

方法名称: validate

返回类型: void

方法说明: 根据模板验证报文。

异常申明:

- 1) IncorrectTagValue 域标号错误异常。
- 2) FieldNotFound 域未发现异常。
- 3) IncorrectDataFormat 域格式错误异常。

参数定义:

- 1) imix.Message message imix 报文对象。

d) validate 方法

方法名称: validate

返回类型: void

方法说明: 根据模板验证报文,并设置是否值验证报文体而忽略头尾。

异常申明:

- 1) IncorrectTagValue 域标号错误异常。
- 2) FieldNotFound 域未发现异常。
- 3) IncorrectDataFormat 域格式错误异常。
- 4) UnsupportedVersion 协议版本不支持异常。

参数定义:

- 1) imix.Message message imix 报文对象。
- 2) boolean bodyOnly 是否只验证报文体。

——Class 名称: **public class** imix.FieldNotFound

IMIX域未发现异常类。

——Class 名称: `public class imix.InvalidMessage`

IMIX非法报文异常类。

——Class 名称: `public class imix.IncorrectDataFormat`

IMIX域数据格式错误异常类。

——Class 名称: `public class imix.IncorrectTagValue`

IMIX域标号错误异常类。

——Class 名称: `public class imix.UnsupportedMessageType`

IMIX报文类型未支持异常类。

——Class 名称: `public class imix.UnsupportedVersion`

IMIX协议版本未支持异常类。

——Class 名称: `public class imix.ConfigError`

IMIX配置错误类。

7.3 基于 XML 的 IMIXML 接口定义

IMIX报文可以通过Schema的约束转换成XML格式，对应的方法如下：

——获得 IMIXML 字符串方法

```
public static String toIMIXML(imix.imix10.Message imixMsg)
```

——从 IMIXML 字符串获得报文方法

```
public static imix.imix10.Message fromIMIXML(String imixmlStr)
```

8 数据传输压缩接口规范

8.1 压缩算法定义

压缩算法分为三个阶段：报文转换、域转换和传输转换三个阶段，对其进行二进制化处理，如图11所示。



图11 数据传输压缩接口流程

压缩算法关键步骤如下：

——报文模板

基于 IMIX 协议，为每种报文类型建立统一的报文模板。传输时，只需按照模板中定义的报文域顺序，在模板编号后添加所有的域值（未赋值的可选域用 NULL 表示，占 1 个字节）和域分隔符即可，以节省报文域号的传输。

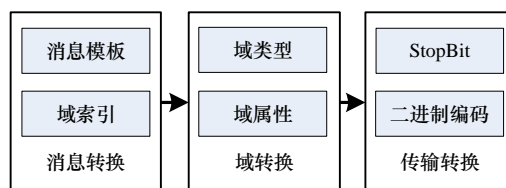
——域索引

根据报文模板，在报文及每个重复组最前面设置域索引，每个比特位 0 或 1 的取值表示相应的域或重复组是否存在。避免使用 NULL 替代未赋值的域，将开销从字节级降至比特级。

——域类型

在模板中将字符串类型的域细分为 ASCII、UTF8、DATE 三个模板域类型。ASCII 对应英文字符；UTF8

对应中文字符；DATE 对应日期、时间和时间戳，本策略将日期、时间转化为 32 位整型，将时间戳转化为 64 位整型，以便二进制编码时进一步压缩空间。

——域属性

在模板中设置某些域的 default 属性及其默认值。若该域在索引中比特位为 1，且域值为 NULL，则取其默认值；若域值不为 NULL，则取其域值。

——StopBit

除 UTF8 以外的域类型，均使用每个字节 8 个比特中的最高位作为 StopBit，来代替 IMIX 报文中的域分隔符<SOH>：1 表示域分隔；0 表示仍为同一域。其余 7 个比特为数据位，从而缩减了域分隔符。而对于 UTF8 域类型，其对应的中文字符编码最高位为 1，使用 StopBit 反而增加编码长度和复杂度，因此通过附加 1 个字节的长度域的方式进行域分隔。

——二进制编码

将整数和浮点数类型的域值作为数值转为二进制形式，而不是以文本字符形式传输；并利用 StopBit，缩减整型数值传输时所占字节数。如：以字符方式传输 IMIX 中的报文时间戳“20090726-13:06:58.100”需 21 个字节，而以 64 位整型数值 20060726130658100 传输只需要 8 个字节；整数 10 传输时只占用 1 个字节。

8.2 传输方式

压缩完的报文是完全的二进制数据流，当通过网络字节流传输时接收方需要能够将报文完整的从字节流中分离出来，所以需要在每条被压缩后的报文头增加报文长度，建议使用 4 个字节长度来表示下面被压缩的报文的长度（可以支持最大 4G 大小被压缩后的报文）。如图 12 所示。

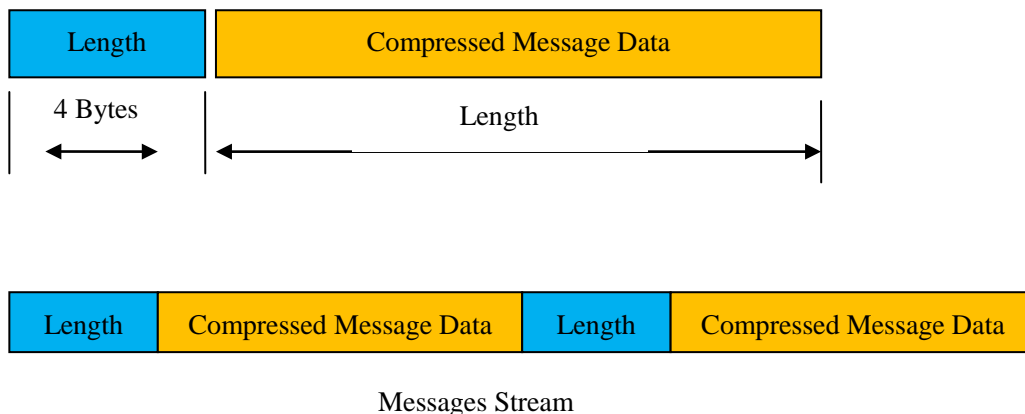

注：统一传输标准，开头的 4 个字节的 long 类型的长度使用的是网络字节序（即 Big-Endian）

图 12 数据压缩传输方式

8.3 压缩接口方法定义

压缩方法定义如下：

——public static byte[] encode(imix.imix10.Message imixMsg)

——public static byte[] encode(String messageData)

解压方法定义如下：

——public static imix.imix10.Message decode(byte[] encoding)

9 数据落地接口规范

IMIX应用系统涉及需要落地的数据分为两类：Store和Queue。Store数据用于存储报文和序列号，保证异步通信的可靠性；Queue数据用于缓解服务器压力，临时存储报文。

9.1 Store 数据落地规范

9.1.1 Store 文件落地规范

文件落地规范包括以下部分：

——文件命名规范

Store文件保存在应用系统配置的路径“FileStorePath”配置项下，缺省为“data/store”。每个IMIX会话store包含4个文件，文件以store的SessionID命名，后缀分别为“.body”、“.header”、“.seqnums”和“.session”。

因为序列号顺序存储，所以各文件在数据交换过程中不可被删除。只有在store被reset时，文件会被自动删除或重命名。

示例：ID为“IMIX.0.1-SENDER-TARGET0”的store所使用的数据文件如图13。



图13 Store 数据文件名示例

——文件结构规范

“.seqnums”文件是定长文件，长10个字节，存储进出两个序列号，结构如图14。

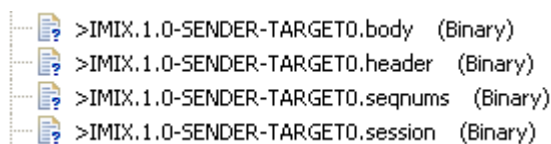

图14 Seqnums 文件结构

“.body”文件是变长文件，里面按顺序存储每条发送过的报文，结构如图15。

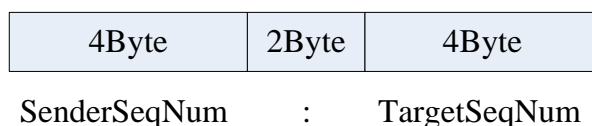

图15 Body 文件结构

“.header”文件是变长文件，存储每条报文的序列号、头部偏移量和长度，用于对发送报文做索引，结构如图16。



图16 Header 文件结构

“.session”文件是定长文件，格式是UTF-8编码的字符串，长度是17字节或21字节，存储store创建时间，结构如图17。

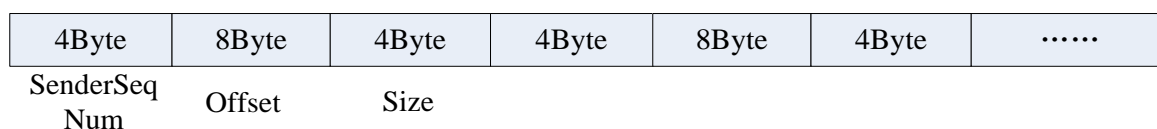

图17 Session 文件结构

9.1.2 Store 数据库落地规范

若使用数据库存储Store数据，需要创建三个表，分别为：SessionTable、MessageTable和MessageStoreTable。

SessionTable用于存放会话信息；MessageTable和MessageStoreTable存储报文内容，使用MsgID字段关联，如报文长度小于4000，直接存放在MessageTable中，超过4000，则存放在MessageStoreTable中。

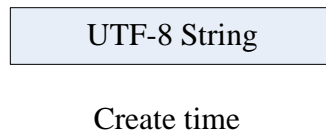
表结构定义如下：

——SessionTable 表结构如表 21。

表21 SessionTable 表结构

字段名	数据类型	长度	是否非空	描述
BeginString	Varchar2	20	是	SessionID 元素。
SenderCompId	Varchar2	50	是	SessionID 元素。
SenderSubId	Varchar2	50	否	SessionID 元素。
TargetCompId	Varchar2	50	是	SessionID 元素。
TargetSubId	Varchar2	50	否	SessionID 元素。
CreationTime	Date		是	Session 创建时间。
IncomingSeqNum	Number	30	是	接收最大序列号。
OutgoingSeqNum	Number	30	是	发送最大序列号。

——MessageTable 表结构如表 22。

表22 MessageTable 表结构

字段名	数据类型	长度	是否非空	描述
MsgId	Number	50	是	报文唯一 ID。
BeginString	Varchar2	20	是	SessionID 元素。
SenderCompId	Varchar2	50	是	SessionID 元素。
SenderSubId	Varchar2	50	否	SessionID 元素。
TargetCompId	Varchar2	50	是	SessionID 元素。
TargetSubId	Varchar2	50	否	SessionID 元素。
MsgSeqNum	Number	30	是	发送的序列号。
Message	Varchar2	4000	否	报文字符串。

——MessageStoreTable 表结构如表 23。

表23 MessageStoreTable 表结构

字段名	数据类型	长度	是否非空	描述
MsgId	Number	50	是	报文唯一 ID。
Message	Clob		是	报文字符串。

9.1.3 Store 数据归档清理规范

Store数据存储报文序列号和报文内容，用于维护数据交换会话通信可靠性。因此Store数据生命周期必须与数据交换会话生命周期保持一致。在会话状态重置或创建新会话时，历史Store数据需被归档清理。

Store数据清理规范如下：

——交互一方发起重置请求流程

根据《银行间市场业务数据交换协议》标准（标准号JR/T 0066）中规定，数据交互会话中一方可发起重置请求报文，进行会话重置和Store数据清理。步骤如下：

- 1、重置发起方发送序号重设模式（SeqReset）SequenceReset报文。
- 2、重置接收方接收请求并出发Store清理工作。
- 3、对于以文件形式落地的Store数据，删除该SessionID下包括后缀为“.body”、“.header”、“.seqnums”和“.session”在内的所有文件；对于以数据库落地的Store数据，以“BeginString”、“SenderCompId”、“SenderSubId”、“TargetCompId”和“TargetSubId”为组合键值（即SessionID），删除“SessionTable”、“MessageTable”和“MessageStoreTable”三张表中数据。

4、序列号重置从自然数1开始。

——定时重置流程

数据交互双方可对会话约定重置周期，如每日0时重置、每周日0时重置等。步骤如下：

- 1、双方断开会话。
- 2、对于以文件形式落地的Store数据，删除该SessionID下包括后缀为“.body”、“.header”、“.seqnums”和“.session”在内的所有文件；对于以数据库落地的Store数据，以“BeginString”、“SenderCompId”、“SenderSubId”、“TargetCompId”和“TargetSubId”为组合键值（即SessionID），删除“SessionTable”、“MessageTable”和“MessageStoreTable”三张表中数据。
- 3、序列号重置从自然数1开始。

9.2 Queue 数据落地规范

基于性能考虑，Queue数据目前只定义一种方式存储，即文件。规范包括以下部分：

——文件命名规范

文件保存在配置的路径下，例如“data/queue”。每个queue生成1个后缀为“time”的文件（文件以queue的ID命名）和若干后缀为“.offset”和“.queue”的文件。Queue中每天的报文存储在不同的文件里，以日期来区分，每天对应一个“.offset”和一个“.queue”文件。此外，“FS.queueTime”文件记录整个QueueServer的操作时间。

通过配置文件设定queue过期的期限，缺省为5天，5天外的数据将不被使用，可根据需要自行备份或删除过期的报文文件。

示例：ID为“IMIX.0.1-SENDER-TARGET0”的queue所使用的的数据文件，该queue生成了3天（2009-6-18到2009-6-20）的数据文件，如图18。



图18 Queue 数据文件名示例

——文件结构规范

“.time”文件是定长文件，格式是UTF-8编码的字符串，长度是17字节或21字节，存储queue操作时间，结构如图19。

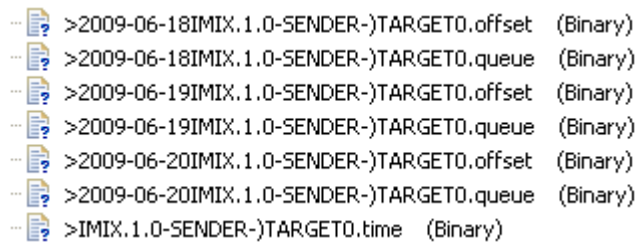

Operate time

图19 Time 文件结构

“.queue”文件是变长文件，格式是一个int型整数和一条报文字符串的循环，存储每条报文，结构如图20。



图20 Queue 文件结构

“.offset”文件是变长文件，存储queue的偏移量，以及最后一条报文是否被取过，结构如图21。

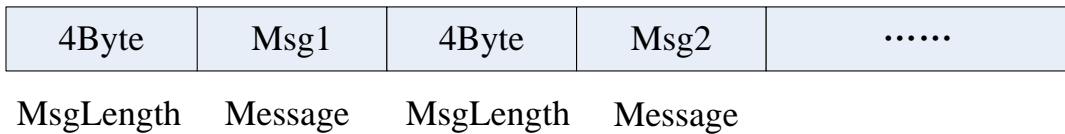

图21 Offset 文件结构

9.3 数据落地编程接口规范

数据落地编程接口公共方法定义如表24。

表24 数据落地编程接口公共方法

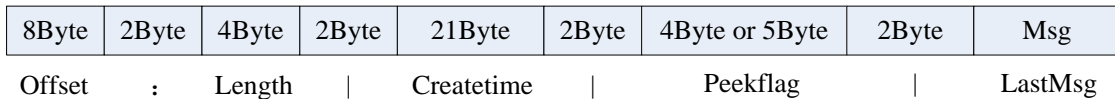
数据处理接口		
public boolean	set(int sequence, String message);	
public void	get(int startSequence, int endSequence, Collection messages) throws IOException;	
public int	getNextSenderMsgSeqNum() throws IOException;	
public int	getNextTargetMsgSeqNum() throws IOException;	
public void	setNextSenderMsgSeqNum(int next) throws IOException;	

public void	setNextTargetMsgSeqNum(int next) throws IOException;	
public void	incrNextSenderMsgSeqNum() throws IOException;	
public void	incrNextTargetMsgSeqNum() throws IOException;	
public Date	getCreationTime() throws IOException;	
public void	reset() throws IOException;	
public void	refresh() throws IOException;	

公共方法具体定义如下：

a) set 方法

方法名称：set

方法类型：非静态

返回类型：boolean

方法说明：设置序列号为sequence的报文为message

异常申明：N/A

参数定义：

1) int sequence 报文保存时对应的报文序列号

2) String message 待保存的报文

b) get 方法

方法名称：get

方法类型：非静态

返回类型：boolean

方法说明：将序列号从startSequence到endSequence的报文放到messages中

异常申明：

1) IOException，若出现 IO 问题，抛出此异常

参数定义：

1) int startSequence 开始的报文对应的序列号

2) int endSequence 结束的报文对应的序列号

3) Collection messages 存放从开始到结束对应的所有报文的容器，用于返回

c) getNextSenderMsgSeqNum 方法

方法名称：getNextSenderMsgSeqNum

方法类型：非静态

返回类型：int

方法说明：得到本方将要发送的下一条报文对应的序列号

异常申明：

1) IOException，若出现 IO 问题，抛出此异常

参数定义：N/A

d) getNextTargetMsgSeqNum 方法

方法名称：getNextTargetMsgSeqNum

方法类型：非静态

返回类型：int

方法说明：得到对手方将要发送的下一条报文对应的序列号

异常申明：

1) IOException，若出现 IO 问题，抛出此异常

参数定义：N/A

e) setNextSenderMsgSeqNum 方法

方法名称: setNextSenderMsgSeqNum

方法类型: 非静态

返回类型: int

方法说明: 设置本方将要发送的下一条报文的序列号

异常申明:

- 1) IOException, 若出现 IO 问题, 抛出此异常

参数定义:

- 1) int next

f) setNextTargetMsgSeqNum 方法

方法名称: setNextTargetMsgSeqNum

方法类型: 非静态

返回类型: int

方法说明: 设置对手方将要发送的下一条报文的序列号

异常申明:

- 1) IOException, 若出现 IO 问题, 抛出此异常

参数定义:

- 1) int next

g) incrNextSenderMsgSeqNum 方法

方法名称: incrNextSenderMsgSeqNum

方法类型: 非静态

返回类型: void

方法说明: 本方待发送报文的序列号增加1

异常申明:

- 1) IOException, 若出现 IO 问题, 抛出此异常

参数定义: N/A

h) incrNextTargetMsgSeqNum 方法

方法名称: incrNextTargetMsgSeqNum

方法类型: 非静态

返回类型: void

方法说明: 对手方待发送报文的序列号增加1

异常申明:

- 1) IOException, 若出现 IO 问题, 抛出此异常

参数定义: N/A

i) getCreationTime 方法

方法名称: getCreationTime

方法类型: 非静态

返回类型: Date

方法说明: 获得session对应创建时间

异常申明: IOException, 若出现IO问题, 抛出此异常

参数定义: N/A

j) reset 方法

方法名称: reset

方法类型：非静态
 返回类型：void
 方法说明：重置整个Message Store
 异常申明：IOException，若出现IO问题，抛出此异常
 参数定义：N/A

k) refresh 方法

方法名称：refresh
 方法类型：非静态
 返回类型：void
 方法说明：从存储介质中重新读取Message Store信息进行刷新
 异常申明：IOException，若出现IO问题，抛出此异常
 参数定义：N/A

10 日志接口规范

日志编程接口公共方法定义如表25。

表25 日志编程接口公共方法

数据处理接口		
public void	clear();	清除日志并且删除所有持久化的日志记录。
public void	onIncoming(String message);	记录一条收到的报文。
public void	onOutgoing(String message);	记录一条发出的报文。
public void	onEvent(String text);	记录一个会话事件。

公共方法具体定义如下：

a) clear 方法

方法名称：clear
 方法类型：非静态
 返回类型：void
 方法说明：清除日志并且删除所有持久化的日志记录
 异常申明：N/A
 参数定义：N/A

b) onIncoming 方法

方法名称：onIncoming
 方法类型：非静态
 返回类型：void
 方法说明：记录一条收到的报文
 异常申明：N/A
 参数定义：

1) String message , String 类型的报文

c) onOutgoing 方法

方法名称：onOutgoing
 方法类型：非静态
 返回类型：void

方法说明：记录一条发出的报文

异常申明：N/A

参数定义：

- 1) String message , String 类型的报文

d) onEvent 方法

方法名称：onEvent

方法类型：非静态

返回类型：void

方法说明：记录一个会话事件

异常申明：N/A

参数定义：

- 1) String message , String 类型的事件

11 配置文件接口规范

IMIX应用允许同时建立多个IMIX会话，包括Initiator和Acceptor。一个IMIX会话可由配置文件中的一块配置中的一组设置来唯一确定（也可以从default 段落继承），其会话ID的设置属性如表26。其中，Sender的设置(SenderCompID和SenderSubID)是本方ID，而Target的设置是对手方的ID。

表26 会话 ID 属性

Setting	Required
BeginString	Y
SenderCompID	Y
SenderSubID	N
TargetCompID	Y
TargetSubID	N

配置文件由两种“配置块头”(heading)构成，分别为[DEFAULT]和[SESSION]头；[SESSION]表示一个新的IMIX Session将要在下面被定义。[DEFAULT]是存放那些可以被其他session继承的设定，前提是这些属性在session各自的定义段落中没有显示地被定义。如果没有提供IMIX 需要的设置，IMIX接口需抛出一个ConfigError，表示找不到配置文件或者配置错误。

具体配置文件说明如表27。

表27 IMIX 配置文件说明

ID	Description	Valid Values	Default
Session			
BeginString	当前 Session 应该用的版本号。	协议版本号。 如：IMIX.1.0。	
SenderCompID	与该 Session 相关的本方 ID。如果属性值为*（针对 acceptor）或%（针对 initiator），则表示真实的值会被动态设定。	大小写敏感的字母-数字的字符串。	

TargetCompID	与该 Session 相关的对手方 ID。如果属性值为* (针对 acceptor) 或% (针对 initiator), 则表示真实的值会被动态设定。	大小写敏感的字母-数字的字符串。	
ConnectionType	定义该 session 充当的类型, 是 initiator 还是 acceptor。	initiator/acceptor Note: Client 只能是 initiator; Server 只能是 acceptor。	
SenderSubID	与该 Session 相关的本方 SubID。如果属性值为* (针对 acceptor) 或% (针对 initiator), 则表示真实的值会被动态设定。	大小写敏感的字母-数字的字符串。	
TargetSubID	与该 Session 相关的对手方 SubID。如果属性值为* (针对 acceptor) 或% (针对 initiator), 则表示真实的值会被动态设定。	大小写敏感的字母-数字的字符串。	
Market	与该 Session 相关的市场类型。(只适用于 Client 和 Hub)。	CFETS-FX/CFETS-FI。	
TimeZone	该 Session 的 Time Zone; 如果设置了该值, session 的开始时间和结束时间将从当前时区转换为 UTC。	Time zone ID (America/New_York, Asia/Tokyo, Europe/London 等)。	
StartTime	该 IMIX Session 启动的时间。	时间格式为 HH:MM:SS [timezone]。其中 timezone 是可选的。如果设置了 TimeZone, 则启用其设定, 如果没有, 则启用缺损的设定, 即 UTC 时区。表示 timezone 的 String 必须是 TimeZone class 能够辨别的字符串。比如, “15:00:00 US/Central”。	
EndTime	该 IMIX Session 停用的时间。	时间格式为 HH:MM:SS [timezone]。其中 timezone 是可选的。如果设置了 TimeZone, 则启用其设定, 如果没有, 则启用缺损的设定, 即 UTC 时区。表示 timezone 的 String 必须是 TimeZone class 能够辨别的字符串。比如, “09:00:00 US/Eastern”。	
StartDay	用于连接长度为期 (或超过) 一周的 session。表示 session 启动的日期。与 StartTime 一起使用。	默认语境中的星期几 (比如 Monday, mon, lundi, lun 等)(注: lundi 是法文)。	
EndDay	用于连接长度为期 (或超过) 一周的 session。表示 session 停用的日期。与 EndTime 一起使用。	默认语境中的星期几 (比如 Monday, mon, lundi, lun 等)(注: lundi 是法文)。	
MillisecondsInTimeStamp	表示是否在 timestamps 中添加	Y 或 N。	Y

	milliseconds.		
LogoutReasonFilePath	Logout reasons 文件的存放路径。	有效的目录或文件路径。	
SessionMappingFilePath	sessionMapping 文件的存放路径。 (只适用于 Agent)	有效的目录或文件路径。	
ImixReceiveQueueSize	receive queue 的大小, 表示在该 queue 中可以 buffer 的报文的数量。用于报文的流量限制。	positive integer.	3000
ImixMaximumConnectionBufferSize	Connection 的 buffer size 的最大值。单位是 byte。用于报文的流量限制。	positive integer.	1048576
Validation			
UseDataDictionary	表示 Session 是否使用数据字典(data dictionary)。如果你会用到 repeating groups, 建议总是使用数据字典。	Y 或 N	Y
DataDictionary	即数据字典, 用于验证收到的 IMIX 报文正确性的 XML 定义文件。如果没有提供数据字典, 则只能验证基础报文的正确性。	Valid XML data dictionary file. Likes IMIX0.xml. 有效的 XML 字典文件, 比如 IMIX10.xml。 如果设定了 UserDataDictionary=Y, 但却没有指定 DataDictionary, 那么 IMIX 会首先根据 session 的 BeginString(比如 , IMIX.1.0=iMIX10.xml) 来查找默认的字典。字典文件的查找策略是首先使用 URL, 然后是文件系统, 然后是线程上下文的 Classloader, (如果有的话)。然后是 DataDictionary 实例的类加载器。	
ValidateFieldsOutOfOrder	如果设置为 N, 则 field 可以乱序排列(比如, body 的 field 在 header 中, 或者 header 的 field 在 body 中)不会被视为非法而被拒绝。适合于连接那些没有进行对 field 进行适当而有序排列的系统。	Y 或 N。	Y
ValidateFieldsHaveValues	如果设置为 N, 则那些不含值(empty)的 field 不会被视为非法而被拒绝。适合于连接那些常不恰当发送空 tag 的系统。	Y 或 N。	Y
ValidateUserDefinedFields	If set to N, user defined fields will not be rejected if they are not defined in the data dictionary, or are present in messages they do not belong to.	Y 或 N。	N

	如果设置为N,首先用户自定义的 field 不会被拒绝,即使这些 field 在字典中没有定义,另外如果这些 field 被放置在了它本不属于的报文中也不会被拒绝。		
CheckLatency	如果设置为 Y,则从对手方发出的报文必须在一个定义的时间区间内(秒为单位)被接收到(查看 MaxLatency)。如果系统使用 localTime 作为它的时间戳,而不是 GMT,则应将其设置为 N。	Y 或 N	Y
MaxLatency	如果 CheckLatency 被设置为 Y,则该值表示了可允许报文延迟最大时间(单位是秒)。默认值是 120 秒。	positive integer。	120
Initiator			
InitiatorTemplate	表示该 session 是 static session 的还是 dynamic session。	Y 或 N。	N
ReconnectInterval	两次重连尝试之间的时间间隔,单位是秒。只用于 initiators。	positive integer。	30
ResetOnLogon	表示在 logon 过程中,是否重置序列号。	Y 或 N。	N
HeartBtInt	心跳间隔,单位是秒。只用于 initiators。	positive integer。	
LogonTimeout	等待 logon response 的时间,单位是秒,如果等待超时,则断开 session。	positive integer。	10
LogoutTimeout	等待 logout response 的时间,单位是秒,如果等待超时,则断开 session。	positive integer。	2
SocketConnectPort	用于建立 session 连接的 Socket 端口号。只适用于 SocketInitiator。	positive integer。	
SocketConnectHost	要连接的 Host 地址。只适用于 SocketInitiator。	格式可以是 x.x.x.x 的有效 IP 地址,或者是一个 domain name。	
SocketConnectHost<n>	用于 session 的失败恢复的可选的 socket 主机地址,其中 n 是一个整数。 比如: SocketConnectHost1, SocketConnectHost2... 必须是连续的,而且要有一个相匹配的 SocketConnectPort[n]	格式可以是 x.x.x.x 的有效 IP 地址,或者是一个 domain name。	
SocketConnectPort<n>	用于 session 的失败恢复的可选的 socket 端口,其中 n 是一个整数。必须与 SocketConnectHost[n] 匹配使用。	positive integer。	
Acceptor			
AcceptorTemplate	表示该 session 是 static session 的还是 dynamic session。	Y 或 N。	N

SocketAcceptPort	用于监听连接的 Socket 端口。只适用于 SocketAcceptor。	有效并被开启的 socket 端口。目前，该值必须在 [DEFAULT] 段落中定义。	
SocketAcceptAddress	用于绑定监听端口的本地 IP 地址。	一个主机名，或者能够被 java.net.InetAddress 解读的 IP 地址。目前，该值必须在 [DEFAULT] 段落中定义。	
RefreshOnLogon	表示当接收到 logon 报文后，刷新 session 的状态。当 message store data 被持久化时，这样的设置可以起到简单的失败恢复的功能。如果 message store data 没有被持久化（如 MemoryStore），那么该设置会被忽略。（在 Hub 和 Server 上，该设置也适用于 Initiator。	Y 或 N。	N
Secure Communication Options			
CAEnable	表示 Session 是否使用 CA 验证（只适用于 agent 和 hub）。	Y 或 N。	N
CAConfigFilePath	CA 配置文件的路径。（只适用于 agent 和 hub）。	有效的目录或文件路径。	
Storage			
FileStoreResetMode	如果设置为 Delete，当 session 被重置后，所有的 message store 会被删除。如果设置为 Rename，当 session 被重置后，所有的 message store 会被重新命名，规则是在每个文件末尾添加时间戳。	Rename/Delete。	Delete
PersistMessages	如果设置为 N，则报文不会被持久化。该设置会强迫 IMIX 总是发送 GapFills 报文，而不是重新发送报文。如果你知道你永远不会重新发送报文，则可以使用该设置。适合于市场数据流。	Y 或 N。	Y
FileStorePath	用于存放 sequence number 和 message 文件的路径。只用于 FileStoreFactory 类。	有效的目录路径。该目录要用于存储文件，所以必须有写权限。	
Miscellaneous			
StoppingPort	接收 STOP 命令的端口（只适用于 agent 和 hub）。	Number。	
ResetOnLogout	表示一个正常的 logout 终止后，是否将报文的 sequence number 重置为 1。	Y 或 N。	N
ResetOnDisconnect	表示一个异常的终止后，是否将报文的 sequence number 重置为 1。	Y 或 N。	N
SendResetSeqNumFlag	当初初始化一个 logon 时，发送一个序列	Y 或 N。	N

	号 reset 报文。		
ContinueInitializationOn Error	如果异常发生依旧初始化 session。	Y 或 N。	N

12 报文快速访问接口规范

IMIX报文采用树形嵌套方式描述复杂业务数据，即业务报文下也循环包含重复组（group）、重复组下可循环嵌套包含重复组。通过快速访问接口方法可直接访问深层嵌套的重复组，包括group中的group。方法定义如下：

——Message.getGroup(String...para)

其中的可变参数需按如下规则使用：

在奇数*i* (*i*=1, 3, 5...) 位置填入需要访问的group的名字，在*i*+1填入需要访问的group的序列号。参数的个数必须是偶数。

示例：

Message_A中有3个Group_a，而每个Group_a中含有4个SubGroup_aa，而每个SubGroup_aa中含有2个域Field_1和Field_2。现在用户想访问该类型报文message_A中第2个Group_a中的第3个SubGroup_aa中的域Field_2，可如下通过该方法得到。

```
SubGroup_aa tmpSubGrp = message_A.getGroup(“Grop_a”, “2”, “SubGoup_aa”, “3”);
Field_2 field_2 = tmpSubGrp.getField_2();
```

以此类推，如果想定位访问第N嵌套层的第K个GroupN，可通过如下调用方法得到：

```
message.getGroup(“Group1”, “i”, “Group2”, “j” …… “GroupN”, “k”);
```

其中“i”，“j”，“k”分别是第1嵌套，第2嵌套和第N嵌套层Group所在的索引。

注意事项：

表示group（或component）位置的序列号必须是从1开始的int值对应的字符串，如果此参数不是int或其代表的int值小于1，则抛出IllegalArgumentException异常。

如果某一group（或component）只有一个，则其对应序列号参数为“1”。

如果参数列表错误，则抛出IllegalArgumentException，如果在解析group或component时出错，则抛出FieldNotFound异常。

如果想得到报文QueryRequest 中的第2个重复组UndInstrmtGrp中的UnderlyingInstrument的域UnderlyingCouponPaymentDate：

```
QueryRequest.getGroup(“UndInstrmtGrp”, “2”, ” UnderlyingInstrument”, “1”).get();
getUnderlyingIssueDate();
```

13 订阅发布模式接口规范

13.1 主题 Topic 的定义

服务器根据一定的规则定义可用的主题名字，并将数据发布到不同的主题上。客户端登录后，根据其订阅的主题发送相应的报文。

主题的命名分两种方式：无层次结构的字符串命名和分层次的主题命名。

无层次的命名方式比较简单，保证名称唯一即可。

分层次主题命名是一种主题(Topic)分组定义的方法，使主题更便于管理和使用。除此之外，还可以使用模式匹配的方式同时订阅多个主题，从而可以完成在单主题订阅模式下无法完成的特性。当对一个主题命名时也同时定义了这个主题所处的层次结构。在一个不分层的命名系统中，所有的名字都是孤

立的，彼此之间没有任何关系，当主题增加时会带来很大的管理负担。而在一个分层次命名系统中名字之间具有一定的上下级关系，从而可以对层次结构中的一组结点进行管理并明确指明结点之间的关系。分层次命名方式使用‘.’分隔符来指明这种上下级关系，类似于文件系统中使用‘/’分隔符来区分上下级目录。向主题发布报文时可以发布到层次结构中的任何一个结点上，而在订阅报文时可以使用模式匹配的方式同时订阅多个主题，这些主题可以是层次结构中的某个分支，也可以是一些并没有命名关系的主题。模式匹配所使用的语法很简单但很强大，可以灵活地选择需要的主题。如图22所示，定义了一个分层次的主题A.B.C.D，订阅者可以直接订阅最顶端的主题A，也可以订阅某一层级上的子主题A.B.C。



图22 分层次主题命名

13.2 订阅报文定义

用于订阅的报文包括：

——订阅请求报文

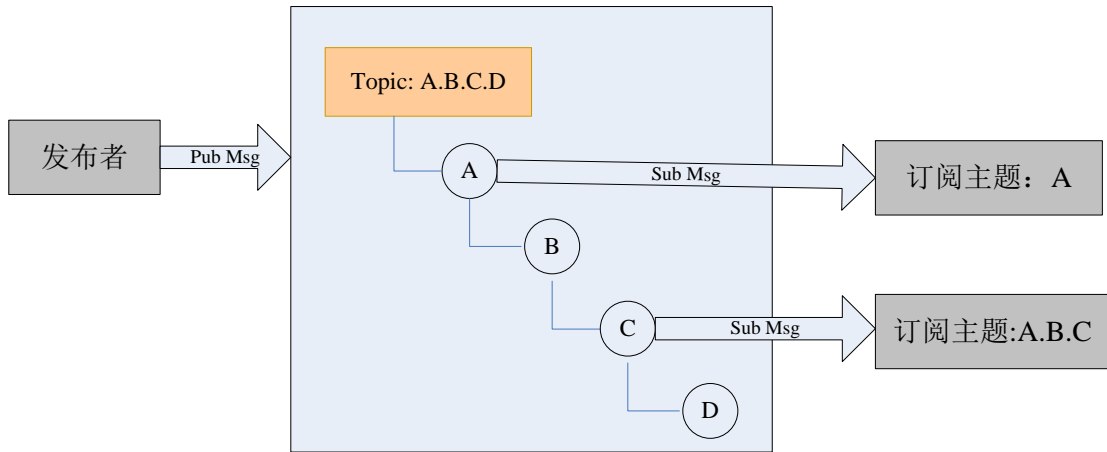
客户端登录后，如果想接收某个主题上的报文，需发送一个订阅请求，报文内至少含有订阅的主题名字和订阅者两部分信息。如果订阅请求被接收，客户端将会收到订阅主题上的业务报文。

——取消订阅报文

当用户不再需要订阅的报文时，需要发送一条取消订阅的请求，报文内含有取消订阅的主题名和订阅者信息，告诉服务器自己不再接收这个主题上的报文。

——订阅异常报文

服务器端在处理订阅请求和取消订阅报文时可能会出现错误，比如订阅的主题不存在，此时需要通过订阅异常报文通知客户端，该报文包含一个错误编码，用户可以根据不同的编码进行相应的处理。

14 业务数据精度标准

14.1 报价数据精度标准

报价数据精度标准如表28。

表28 报价数据精度标准

产品	属性	界面精度	XML 数据精度	报文数据精度
债券买卖	净价（元）	4	4	4
	全价（元）	4	4	4

	交易金额（元）	2	2	2
	券面总额（万元）	0	0	0
	应计利息（元）	5	5	5
	收益率（%）	4	4	4
	结算金额（元）	2	2	2
质押式回购	回购利率（%）	4	4	4
	交易金额（元）	2	2	2
	到期结算金额（元）	2	2	2
	券面总额（万元）	0	0	0
买断式回购	首次净价（元）	4	4	4
	首次收益率（%）	4	4	4
	首次应计利息（元）	5	5	5
	到期净价（元）	4	4	4
	到期收益率（%）	4	4	4
	到期应计利息（元）	5	5	5
	首次全价（元）	4	4	4
	首次结算金额（元）	2	2	2
	到期全价（元）	4	4	4
	到期结算金额（元）	2	2	2
	保证金金额（万元）	4	4	4
	保证金券面总额合计（万元）	0	0	0
债券远期	远期净价（元）	4	4	4
	远期收益率（%）	4	4	4
	券面总额（万元）	0	0	0
	交易金额（元）	2	2	2
	应计利息（元）	5	5	5
	全价（元）	4	4	4
	结算金额（元）	2	2	2
	保证金金额（万元）	4	4	4
	保证金券面总额合计（万元）	0	0	0
信用拆借	拆借利率（%）	4	4	4
	拆借金额（万元）	2	2	2
	应计利息（元）	2	2	2
	到期还款金额（元）	2	2	2
远期利率协议	名义本金（万元）	0	0	0
	固定利率（%）	4	4	4
	浮动利率（%）	6	6	6
	贴现率（%）	6	6	6
	保证金金额（万元）	4	4	4
	保证金全面总额（万元）	0	0	0
	券面总额合计（万元）	0	0	无此域

债券借贷	借贷费率 (%)	4	4	4
	标的债券券面总额 (万元)	0	0	0
	借贷费用 (元)	2	2	2
	质押债券券面总额 (万元)	0	0	0
利率互换	名义本金金额 (万元)	0	0	0
	固定利率 (%)	4	4	4
	参考利率利差 (bps)	2	2	2
	初始互换金额 (元)	0	0	0
	名义本金重置百分比 (%)	2	2	2
	名义本金重置金额 (万元)	0	0	0
	保证金金额 (万元)	4	4	4
	保证金券面总额 (万元)	0	0	0
资产支持证券	每百元本金额 (元)	2	2	2
	净价 (元)	4	4	4
	券面总额 (万元)	0	0	0
	当前本金额 (元)	2	2	2
	交易金额 (元)	2	2	2
	应计利息 (元)	5	5	5
	全价 (元)	5	5	5
	应计利息总额 (元)	2	2	2
	结算金额 (元)	2	2	2
	最小成交券面总额 (万元)	0	0	0
	最大成交券面总额 (万元)	0	0	0
	最大显示券面总额 (万元)	0	0	0
	最小变动单位 (万元)	0	0	0
	已成交券面总额 (万元)	0	0	0
	未成交量 (万元)	0	0	0

14.2 成交数据精度标准

成交数据精度标准如表29。

表29 成交数据精度标准

产品	属性	界面精度	XML 数据精度	报文数据精度
债券买卖	净价 (元)	4	4	4
	全价 (元)	4	4	4
	交易金额 (元)	2	2	2
	券面总额 (万元)	0	0	0
	应计利息 (元)	5	5	5
	应计利息总额 (元)	2	2	2

	收益率 (%)	4	4	4
	结算金额 (元)	2	2	2
质押式回购	回购利率 (%)	4	4	4
	交易金额 (元)	2	2	2
	到期结算金额 (元)	2	2	2
	券面总额 (万元)	0	0	0
买断式回购	首次净价 (元)	4	4	4
	首次收益率 (%)	4	4	4
	首次应计利息 (元)	5	5	5
	到期净价 (元)	4	4	4
	到期收益率 (%)	4	4	4
	到期应计利息 (元)	5	5	5
	首次全价 (元)	4	4	4
	首次结算金额 (元)	2	2	2
	到期全价 (元)	4	4	4
	到期结算金额 (元)	2	2	2
	保证金金额 (万元)	4	4	4
	保证金券面总额合计 (万元)	0	0	0
债券远期	远期净价 (元)	4	4	4
	远期收益率 (%)	4	4	4
	券面总额 (万元)	0	0	0
	交易金额 (元)	2	2	2
	应计利息 (元)	5	5	5
	全价 (元)	4	4	4
	结算金额 (元)	2	2	2
	保证金金额 (万元)	4	4	4
	保证金券面总额合计 (万元)	0	0	0
信用拆借	拆借利率 (%)	4	4	4
	拆借金额 (万元)	2	2	2
	应计利息 (元)	2	2	2
	到期还款金额 (元)	2	2	2
远期利率协议	名义本金 (万元)	0	0	0
	固定利率 (%)	4	4	4
	浮动利率 (%)	6	6	6
	贴现率 (%)	6	6	6
	保证金金额 (万元)	4	4	4
	保证金全面总额 (万元)	0	0	0
	券面总额合计 (万元)	0	0	无此域
债券借贷	借贷费率 (%)	4	4	4
	标的债券券面总额 (万元)	0	0	0
	借贷费用 (元)	2	2	2

	质押债券券面总额 (万元)	0	0	0
利率互换	名义本金金额 (万元)	0	0	0
	固定利率 (%)	4	4	4
	参考利率利差 (bps)	2	2	2
	初始互换金额 (元)	0	0	0
	名义本金重置百分比 (%)	2	2	2
	名义本金重置金额 (万元)	0	0	0
	保证金金额 (万元)	4	4	4
	保证金券面总额 (万元)	0	0	0
	保证金券面总额合计 (万元)	0	0	0
资产支持证券	每百元本金额 (元)	2	2	2
	净价 (元)	4	4	4
	券面总额 (万元)	0	0	0
	当前本金额 (元)	2	2	2
	交易金额 (元)	2	2	2
	应计利息 (元)	5	5	5
	全价 (元)	4	4	4
	应计利息总额 (元)	2	2	2
	结算金额 (元)	2	2	2
	最小成交券面总额 (万元)	0	0	无此域
	最大成交券面总额 (万元)	0	0	无此域
	最大显示券面总额 (万元)	0	0	无此域
	最小变动单位 (万元)	0	0	无此域
	已成交券面总额 (万元)	0	0	0
	未成交量 (万元)	0	0	0

附 录 A
(资料性附录)
IMIX 协议元数据模板

```

<?xml version="1.0" encoding="utf-8"?>
<imix major="1" minor="0" version="1.109">
  <header>
    <field name="BeginString" required="Y" />
    <field name="BodyLength" required="Y" />
    <field name="MsgSeqNum" required="Y" />
    <field name="MsgType" required="Y" />
    <field name="SenderCompID" required="Y" />
    <field name="SendingTime" required="Y" />
    <field name="TargetCompID" required="Y" />
    <field name="DeliverToCompID" required="N" />
    <field name="DeliverToSubID" required="N" />
    <field name="ErrorCode" required="N" />
    <field name="LastMsgSeqNumProcessed" required="N" />
    <field name="MessageEncoding" required="N" />
    <field name="OnBehalfOfCompID" required="N" />
    <field name="OnBehalfOfSubID" required="N" />
    <field name="OrigSendingTime" required="N" />
    <field name="PossDupFlag" required="N" />
    <field name="PossResend" required="N" />
    <field name="SecureData" required="N" />
    <field name="SecureDataLen" required="N" />
    <field name="SegmentID" required="N" />
    <field name="SenderSubID" required="N" />
    <field name="SignatureMethod" required="N" />
    <field name="SysSeqNo" required="N" />
    <field name="TargetSubID" required="N" />
    <field name="UserSeqNo" required="N" />
    <component name="HopsGroup" required="N" />
  </header>
  <trailer>
    <field name="Checksum" required="Y" />
    <field name="Signature" required="N" />
    <field name="SignatureLength" required="N" />
  </trailer>
  <messages>
    <message name="ADFRRequest" description="" msgtype="U24" msgcat="app">

```

```

    <field name="RICName" required="N" />
    <field name="Text" required="N" />
    <field name="TransactTime" required="N" />
</message>
<message name="ADFResponse" description="" msgtype="U25" msgcat="app">
    <field name="ExecID" required="N" />
    <field name="NDFCurrency" required="N" />
    <field name="NDFDate" required="N" />
    <field name="Side" required="N" />
    <field name="Text" required="N" />
    <field name="TradeDate" required="N" />
    <field name="TradeTime" required="N" />
    <field name="TransactTime" required="N" />
    <component name="LiquidProviderGrp" required="N" />
    <component name="MDTypeGrp" required="N" />
    <component name="Parties" required="N" />
</message>
<message name="BreakContractRequest" description="" msgtype="U08"
msgcat="app">
    <field name="BreakContractRequestID" required="N" />
    <field name="BreakContractRequestType" required="N" />
    <field name="ExecID" required="N" />
    <field name="TradeDate" required="N" />
    <field name="TradeTime" required="N" />
    <field name="TransactTime" required="N" />
    <component name="Parties" required="N" />
</message>
<message name="BreakContractRequestAck" description="" msgtype="U09"
msgcat="app">
    <field name="BreakContraAckStatus" required="N" />
    <field name="BreakContractRequestID" required="N" />
    <field name="ExecID" required="N" />
    <field name="TransactTime" required="N" />
    <component name="Parties" required="N" />
</message>
<message name="BulletinInquiry" description="" msgtype="U62" msgcat="app">
    <field name="BulletinByIndc" required="N" />
    <field name="BulletinInqID" required="N" />
    <field name="IssueDate" required="N" />
    <field name="QueryEndDate" required="N" />
    <field name="QueryPageNumber" required="N" />
    <field name="QueryStartDate" required="N" />
    <field name="SentOrReceived" required="N" />

```

```

    <field name="TransactTime" required="N" />
</message>
<message name="BulletinReport" description="" msgtype="U63" msgcat="app">
  <field name="BulletinInqID" required="N" />
  <field name="BulletinRptID" required="N" />
  <field name="BulletinStatus" required="N" />
  <field name="BulletinTransType" required="N" />
  <field name="SettlReportType" required="N" />
  <field name="Text" required="N" />
  <field name="TransactTime" required="N" />
  <component name="BulletinGrp" required="N" />
  <component name="PaginationCtrl" required="N" />
</message>
<message name="BulletinReportAck" description="" msgtype="U64" msgcat="app">
  <field name="BulletinInfoStatus" required="N" />
  <field name="BulletinRptID" required="N" />
  <field name="Text" required="N" />
  <field name="TransactTime" required="N" />
</message>
<message name="BusinessMessageReject" description="" msgtype="j"
msgcat="app">
  <field name="BusinessRejectReason" required="N" />
  <field name="BusinessRejectRefID" required="N" />
  <field name="EncodedText" required="N" />
  <field name="EncodedTextLen" required="N" />
  <field name="RefMsgType" required="N" />
  <field name="RefSeqNum" required="N" />
  <field name="Text" required="N" />
  <field name="TransactTime" required="N" />
</message>
<message name="CollAssignmentResponse" description="" msgtype="U47"
msgcat="app">
  <field name="AssignmentRespStatus" required="N" />
  <field name="CollAsgnID" required="N" />
  <field name="CollAsgnRespID" required="N" />
  <field name="Text" required="N" />
  <field name="TransactTime" required="N" />
</message>
<message name="CollAssignmentResponseAck" description="" msgtype="U61"
msgcat="app">
  <field name="CollAsgnRespID" required="N" />
  <field name="TransactTime" required="N" />
</message>

```

```

    <message name="CollateralARDtlReport" description="" msgtype="U55"
msgcat="app">
    <field name="ARReportType" required="N" />
    <field name="CollARDtlRptID" required="N" />
    <field name="CollARInquiryID" required="N" />
    <field name="CollARRptStatus" required="N" />
    <field name="SettlReportType" required="N" />
    <field name="Text" required="N" />
    <field name="TransactTime" required="N" />
    <component name="MarginARDtlGrp" required="N" />
    <component name="Parties" required="N" />
</message>
    <message name="CollateralARDtlRptAck" description="" msgtype="U56"
msgcat="app">
    <field name="CollARDtlRptID" required="N" />
    <field name="TransactTime" required="N" />
</message>
    <message name="CollateralARInquiry" description="" msgtype="U54"
msgcat="app">
    <field name="ARReportType" required="N" />
    <field name="CollARInquiryID" required="N" />
    <field name="TransactTime" required="N" />
</message>
    <message name="CollateralAssignment" description="" msgtype="AY"
msgcat="app">
    <field name="CollARInquiryID" required="N" />
    <field name="CollAsgnID" required="N" />
    <field name="CollAsgnReason" required="N" />
    <field name="Currency" required="N" />
    <field name="CurrNumOfTot" required="N" />
    <field name="LastRptRequested" required="N" />
    <field name="MarginIndicator" required="N" />
    <field name="PaymentRoute" required="N" />
    <field name="Quantity" required="N" />
    <field name="RelatedReference" required="N" />
    <field name="SettlDate" required="N" />
    <field name="SettlReportStatus" required="N" />
    <field name="SettlReportType" required="N" />
    <field name="SWIFTType" required="N" />
    <field name="Text" required="N" />
    <field name="TotNumReports" required="N" />
    <field name="TradeDate" required="N" />
    <field name="TransactTime" required="N" />

```

```

    <component name="Instrument" required="N" />
    <component name="MarginInfoGrp" required="N" />
    <component name="Parties" required="N" />
</message>
<message name="CollateralAssignmentAck" description="" msgtype="U37"
msgcat="app">
    <field name="CollAsgnID" required="N" />
    <field name="TransactTime" required="N" />
</message>
<message name="CollateralBaseInfo" description="" msgtype="U52"
msgcat="app">
    <field name="CollBaseInfoID" required="N" />
    <field name="CollBaseInfoReqID" required="N" />
    <field name="SettlReportStatus" required="N" />
    <field name="SettlReportType" required="N" />
    <field name="Text" required="N" />
    <field name="TransactTime" required="N" />
    <component name="MarginBaseInfoGrp" required="N" />
    <component name="RateBaseInfo" required="N" />
</message>
<message name="CollateralBaseInfoAck" description="" msgtype="U59"
msgcat="app">
    <field name="CollBaseInfoID" required="N" />
    <field name="TransactTime" required="N" />
</message>
<message name="CollateralBaseInfoRequest" description="" msgtype="U53"
msgcat="app">
    <field name="CollBaseInfoReqID" required="N" />
    <field name="TransactTime" required="N" />
</message>
<message name="CollateralDetailReport" description="" msgtype="U35"
msgcat="app">
    <field name="ClearingBusinessDate" required="N" />
    <field name="CollDetailRepID" required="N" />
    <field name="CollInquiryID" required="N" />
    <field name="CollInquiryType" required="N" />
    <field name="CurrNumOfTot" required="N" />
    <field name="ExecID" required="N" />
    <field name="InterestRecDate" required="N" />
    <field name="LastRptRequested" required="N" />
    <field name="QueryRequestID" required="N" />
    <field name="SettlReportStatus" required="N" />
    <field name="SettlReportType" required="N" />

```

```

    <field name="Text" required="N" />
    <field name="TotNumReports" required="N" />
    <field name="TradeDate" required="N" />
    <field name="TransactTime" required="N" />
    <field name="U35DataType" required="N" />
    <component name="MarginInfoGrp" required="N" />
    <component name="Parties" required="N" />
</message>
<message name="CollateralDetailReportAck" description="" msgtype="U36"
msgcat="app">
    <field name="CollDetailRepID" required="N" />
    <field name="TransactTime" required="N" />
</message>
<message name="CollateralDPDtlReport" description="" msgtype="U42"
msgcat="app">
    <field name="CollDPDtlRptID" required="N" />
    <field name="CollDPInquiryID" required="N" />
    <field name="CollDPRptStatus" required="N" />
    <field name="DPReportType" required="N" />
    <field name="SettlReportStatus" required="N" />
    <field name="SettlReportType" required="N" />
    <field name="Text" required="N" />
    <field name="TransactTime" required="N" />
    <component name="MarginDPDtlGrp" required="N" />
    <component name="Parties" required="N" />
</message>
<message name="CollateralDPDtlRptAck" description="" msgtype="U44"
msgcat="app">
    <field name="CollDPDtlRptID" required="N" />
    <field name="TransactTime" required="N" />
</message>
<message name="CollateralDPInquiry" description="" msgtype="U43"
msgcat="app">
    <field name="CollDPInquiryID" required="N" />
    <field name="CollDPInquiryType" required="N" />
    <field name="SettlDate" required="N" />
    <field name="TransactTime" required="N" />
</message>
<message name="CollateralDrawRequest" description="" msgtype="U10"
msgcat="app">
    <field name="DrawAmt" required="N" />
    <field name="DrawRequestID" required="N" />
    <field name="DrawRequestTime" required="N" />

```



```

    <field name="TransactTime" required="N" />
    <component name="MarginDPDtlGrp" required="N" />
    <component name="Parties" required="N" />
</message>
<message name="CollateralDrawRequestAck" description="" msgtype="U11"
msgcat="app">
    <field name="DrawAmt" required="N" />
    <field name="DrawReqAckStatus" required="N" />
    <field name="DrawRequestID" required="N" />
    <field name="DrawRequestTime" required="N" />
    <field name="TransactTime" required="N" />
    <component name="Parties" required="N" />
</message>
<message name="CollateralDrawResponse" description="" msgtype="U12"
msgcat="app">
    <field name="DrawAmt" required="N" />
    <field name="DrawReqRejReason" required="N" />
    <field name="DrawRequestID" required="N" />
    <field name="DrawRequestTime" required="N" />
    <field name="DrawRespID" required="N" />
    <field name="DrawRespStatus" required="N" />
    <field name="Text" required="N" />
    <field name="TransactTime" required="N" />
    <component name="Parties" required="N" />
</message>
<message name="CollateralDrawResponseAck" description="" msgtype="U13"
msgcat="app">
    <field name="DrawAmt" required="N" />
    <field name="DrawRequestID" required="N" />
    <field name="DrawRequestTime" required="N" />
    <field name="DrawRespAckStatus" required="N" />
    <field name="DrawRespID" required="N" />
    <field name="TransactTime" required="N" />
    <component name="Parties" required="N" />
</message>
<message name="CollateralInfoChange" description="" msgtype="U14"
msgcat="app">
    <field name="CollateralInfoChangeID" required="N" />
    <field name="CollateralInfoChangeType" required="N" />
    <field name="ExecID" required="N" />
    <field name="TradeDate" required="N" />
    <field name="TradeTime" required="N" />
    <field name="TransactTime" required="N" />

```

```

    <component name="ExecCollGrp" required="N" />
    <component name="MarginAccountInfo" required="N" />
    <component name="Parties" required="N" />
</message>
<message name="CollateralInfoChangeAck" description="" msgtype="U15"
msgcat="app">
    <field name="CollateralInfoChangeAckStatus" required="N" />
    <field name="CollateralInfoChangeID" required="N" />
    <field name="TransactTime" required="N" />
</message>
<message name="CollateralInfoChangeRequest" description="" msgtype="U28"
msgcat="app">
    <field name="CollateralInfoChangeID" required="N" />
    <field name="CollateralInfoChangeType" required="N" />
    <field name="TransactTime" required="N" />
</message>
<message name="CollateralInquiry" description="" msgtype="BB" msgcat="app">
    <field name="ClearingBusinessDate" required="N" />
    <field name="CollInquiryID" required="N" />
    <field name="CollInquiryType" required="N" />
    <field name="TradeDate" required="N" />
    <field name="TransactTime" required="N" />
    <component name="Parties" required="N" />
</message>
<message name="CollDrawCancelRequest" description="" msgtype="U46"
msgcat="app">
    <field name="DrawAmt" required="N" />
    <field name="DrawCancelRequestID" required="N" />
    <field name="DrawRequestID" required="N" />
    <field name="TransactTime" required="N" />
    <component name="MarginDPDtIGrp" required="N" />
    <component name="Parties" required="N" />
</message>
<message name="CollDrawCancelResponse" description="" msgtype="U67"
msgcat="app">
    <field name="DrawCancelRejReason" required="N" />
    <field name="DrawCancelRequestID" required="N" />
    <field name="DrawCancelRespID" required="N" />
    <field name="DrawCancelRespStatus" required="N" />
    <field name="Text" required="N" />
    <field name="TransactTime" required="N" />
</message>
<message name="CollDrawCancelResponseAck" description="" msgtype="U57"

```

```

msgcat="app">
  <field name="DrawCancelRespID" required="N" />
  <field name="TransactTime" required="N" />
</message>
<message name="CollTransferRequest" description="" msgtype="U48"
msgcat="app">
  <field name="CollTransferCnclID" required="N" />
  <field name="CollTransferReqID" required="N" />
  <field name="TransactTime" required="N" />
  <field name="TransferDirection" required="N" />
  <field name="TransferReqType" required="N" />
  <component name="MarginAMTGrp" required="N" />
  <component name="Parties" required="N" />
</message>
<message name="CollTransferRequestAck" description="" msgtype="U49"
msgcat="app">
  <field name="CollTransferReqID" required="N" />
  <field name="TransactTime" required="N" />
</message>
<message name="CollTransferResponse" description="" msgtype="U50"
msgcat="app">
  <field name="CollTransferCnclID" required="N" />
  <field name="CollTransferReqID" required="N" />
  <field name="CollTransferRespID" required="N" />
  <field name="Text" required="N" />
  <field name="TransactTime" required="N" />
  <field name="TransferDirection" required="N" />
  <field name="TransferReqRejReason" required="N" />
  <field name="TransferReqType" required="N" />
  <field name="TransferRespStatus" required="N" />
  <component name="MarginAMTGrp" required="N" />
  <component name="Parties" required="N" />
</message>
<message name="CollTransferResponseAck" description="" msgtype="U51"
msgcat="app">
  <field name="CollTransferRespID" required="N" />
  <field name="TransactTime" required="N" />
</message>
<message name="Confirmation" description="" msgtype="AK" msgcat="app">
  <field name="CNYTradedIndic" required="N" />
  <field name="ConfirmID" required="N" />
  <field name="ConfirmReqID" required="N" />
  <field name="ConfirmStatus" required="N" />

```

```

    <field name="MarketIndicator" required="N" />
    <field name="TradeInstrument" required="N" />
    <field name="TradSesCloseTime" required="N" />
    <field name="TransactTime" required="N" />
</message>
<message name="Confirmation_Ack" description="" msgtype="AU" msgcat="app">
    <field name="ConfirmID" required="N" />
    <field name="TransactTime" required="N" />
</message>
<message name="ConfirmationRequest" description="" msgtype="BH"
msgcat="app">
    <field name="CNYTradedIndic" required="N" />
    <field name="ConfirmReqID" required="N" />
    <field name="ConfirmType" required="N" />
    <field name="MarketIndicator" required="N" />
    <field name="TradeInstrument" required="N" />
    <field name="TransactTime" required="N" />
</message>
<message name="DataDownloadRequest" description="" msgtype="U06"
msgcat="app">
    <field name="DataDownloadEndTime" required="N" />
    <field name="DataDownloadStartTime" required="N" />
    <field name="DataDownloadType" required="N" />
    <field name="DownloadRequestID" required="N" />
    <field name="TradeMethod" required="N" />
    <field name="TransactTime" required="N" />
    <component name="DownloadParamGrp" required="N" />
    <component name="Instrument" required="N" />
    <component name="Parties" required="N" />
</message>
<message name="DataDownloadResponse" description="" msgtype="U07"
msgcat="app">
    <field name="DataDownloadType" required="N" />
    <field name="DownloadRequestID" required="N" />
    <field name="GrossOrNet" required="N" />
    <field name="LimitCategory" required="N" />
    <field name="LimitValue" required="N" />
    <field name="NoLimitInfo" required="N" />
    <field name="NoLimits" required="N" />
    <field name="TradeMethod" required="N" />
    <field name="TransactTime" required="N" />
    <field name="ValidUntilDate" required="N" />
    <component name="DownloadedDataGrp" required="N" />

```

```

    <component name="Instrument" required="N" />
    <component name="Parties" required="N" />
</message>
<message name="ExecutionAcknowledgement" description="" msgtype="BN"
msgcat="app">
    <field name="ClOrdID" required="N" />
    <field name="CNYTradedIndic" required="N" />
    <field name="DKReason" required="N" />
    <field name="ExecAckStatus" required="N" />
    <field name="ExecID" required="N" />
    <field name="OrderID" required="N" />
    <field name="QuoteID" required="N" />
    <field name="Text" required="N" />
    <field name="TradeInstrument" required="N" />
    <field name="TransactTime" required="N" />
    <component name="Instrument" required="N" />
</message>
<message name="ExecutionReport" description="" msgtype="8" msgcat="app">
    <field name="AccruedInterestAmt" required="N" />
    <field name="AccruedInterestRate" required="N" />
    <field name="AccruedInterestTotalAmt" required="N" />
    <field name="AnonymousIndicator" required="N" />
    <field name="AutoTraderPickup" required="N" />
    <field name="BaseAmountDPs" required="N" />
    <field name="CalculateAgency" required="N" />
    <field name="CalculatedCcyLastQty" required="N" />
    <field name="CashHoldingDays" required="N" />
    <field name="CashPaymentType" required="N" />
    <field name="ClOrdID" required="N" />
    <field name="CNYTradedIndic" required="N" />
    <field name="CollateralType" required="N" />
    <field name="ContingencyIndicator" required="N" />
    <field name="CouponPaymentDateReset" required="N" />
    <field name="CouponPaymentIndicator" required="N" />
    <field name="Currency" required="N" />
    <field name="Currency1" required="N" />
    <field name="Currency2" required="N" />
    <field name="DataCategoryIndicator" required="N" />
    <field name="DataSource" required="N" />
    <field name="DataSourceString" required="N" />
    <field name="DateConfirmed" required="N" />
    <field name="DayCount" required="N" />
    <field name="DealID" required="N" />

```

```
<field name="DealMethod" required="N" />
<field name="DealSerialNo" required="N" />
<field name="DealTransType" required="N" />
<field name="DecimalPlaces" required="N" />
<field name="DeliveryDate" required="N" />
<field name="DerivativeExerciseStatus" required="N" />
<field name="DerivativeExerciseStyle" required="N" />
<field name="DerivativeOptAttribute" required="N" />
<field name="DirtyPrice" required="N" />
<field name="DirtyPrice2" required="N" />
<field name="DiscountRate" required="N" />
<field name="DisplayQty" required="N" />
<field name="DisputeSettlementMethod" required="N" />
<field name="DownloadedDataType" required="N" />
<field name="DownloadRequestID" required="N" />
<field name="DV01" required="N" />
<field name="EffectiveTime" required="N" />
<field name="EncodedText" required="N" />
<field name="EncodedTextLen" required="N" />
<field name="ExecID" required="N" />
<field name="ExecInst" required="N" />
<field name="ExecRptDataIndic" required="N" />
<field name="ExecType" required="N" />
<field name="ExpireDate" required="N" />
<field name="ExpireTime" required="N" />
<field name="ExpireTimeZone" required="N" />
<field name="ForwardScaleDecimalPlaces" required="N" />
<field name="FWDecimalPlaces" required="N" />
<field name="InCompetition" required="N" />
<field name="Industry" required="N" />
<field name="IniExReqIndicator" required="N" />
<field name="InterestAccrualMethod" required="N" />
<field name="InterestAccrualDaysAdjustment" required="N" />
<field name="InterestFixDate" required="N" />
<field name="InterestFixDateAdjustment" required="N" />
<field name="LastForwardPoints" required="N" />
<field name="LastModifyTime" required="N" />
<field name="LastPx" required="N" />
<field name="LastQty" required="N" />
<field name="LastSpotRate" required="N" />
<field name="LastSwapPoints" required="N" />
<field name="LeavesTotalQty" required="N" />
<field name="LegInfrmnIndicator" required="N" />
```

```
<field name="LimitOrderSubType" required="N" />
<field name="MarginChangeIndicator" required="N" />
<field name="MarginRequired" required="N" />
<field name="MaturityDateType" required="N" />
<field name="MaxFloor" required="N" />
<field name="MaxQty" required="N" />
<field name="MinQty" required="N" />
<field name="MinTickSize" required="N" />
<field name="MMETSId" required="N" />
<field name="NDFCurrency" required="N" />
<field name="NDFDate" required="N" />
<field name="NegotiationCount" required="N" />
<field name="NetCashFlowPV" required="N" />
<field name="NetGrossInd" required="N" />
<field name="NetMoney" required="N" />
<field name="NotionalExchangeType" required="N" />
<field name="OPTDataType" required="N" />
<field name="OptPayoutType" required="N" />
<field name="OrderEntryTime" required="N" />
<field name="OrderID" required="N" />
<field name="OrdQtyResetAmount" required="N" />
<field name="OrdQtyResetDate" required="N" />
<field name="OrdQtyResetFrequency" required="N" />
<field name="OrdQtyResetPercentage" required="N" />
<field name="OrdQtyResetRequired" required="N" />
<field name="OrdQtyResetType" required="N" />
<field name="OrdRejReason" required="N" />
<field name="OrdStatus" required="N" />
<field name="OrdStatusReqID" required="N" />
<field name="OrdType" required="N" />
<field name="ParentOrderID" required="N" />
<field name="PayTotalSettlAmt" required="N" />
<field name="PortfolioID" required="N" />
<field name="PortfolioName" required="N" />
<field name="PreDealFlag" required="N" />
<field name="Price" required="N" />
<field name="PriceType" required="N" />
<field name="QueryOrdStatus" required="N" />
<field name="QueryRequestID" required="N" />
<field name="QueryResultStatus" required="N" />
<field name="QuoteID" required="N" />
<field name="QuoteRespID" required="N" />
<field name="QuoteTime" required="N" />
```

```
<field name="QuoteType" required="N" />
<field name="ReasonType" required="N" />
<field name="RecTotalSettlAmt" required="N" />
<field name="Reference" required="N" />
<field name="RelatedReference" required="N" />
<field name="RemarkIndicator" required="N" />
<field name="RiskCurrency" required="N" />
<field name="RiskLastQty" required="N" />
<field name="RoundDownCurrencies" required="N" />
<field name="SecurityHoldingDays" required="N" />
<field name="SettlCurrAmt" required="N" />
<field name="SettlCurrAmt2" required="N" />
<field name="SettlCurrency" required="N" />
<field name="SettlCurrency2" required="N" />
<field name="SettlDate" required="N" />
<field name="SettlDate2" required="N" />
<field name="SettlDateAdjustment" required="N" />
<field name="SettlDateTerm" required="N" />
<field name="SettlResetDate" required="N" />
<field name="SettlType" required="N" />
<field name="Side" required="N" />
<field name="SpotDate" required="N" />
<field name="StopPx" required="N" />
<field name="StrikeDayPrice" required="N" />
<field name="StrikeTime" required="N" />
<field name="StrikeUser" required="N" />
<field name="StubIndicator" required="N" />
<field name="StubRequired" required="N" />
<field name="SupplementaryClause" required="N" />
<field name="TermAmountDPs" required="N" />
<field name="TerminationTime" required="N" />
<field name="Text" required="N" />
<field name="TimeInForce" required="N" />
<field name="TimeToLive" required="N" />
<field name="TotalDiscountAmt" required="N" />
<field name="TradeCashAmt" required="N" />
<field name="TradeCashSpread" required="N" />
<field name="TradeDate" required="N" />
<field name="TradeFwdDays" required="N" />
<field name="TradeInstrument" required="N" />
<field name="TradeLimitDays" required="N" />
<field name="TradeMethod" required="N" />
<field name="TradeSubType" required="N" />
```



```

<field name="TradeTime" required="N" />
<field name="TradeType" required="N" />
<field name="TradingSessionID" required="N" />
<field name="TransactTime" required="N" />
<field name="Turnover" required="N" />
<field name="UpdateTime" required="N" />
<field name="Username" required="N" />
<field name="Volatility" required="N" />
<component name="ContAmtGrp" required="N" />
<component name="DeliveryOptionGrp" required="N" />
<component name="FinancingDetails" required="N" />
<component name="InitialExGrp" required="N" />
<component name="InstrmtLegExecGrp" required="N" />
<component name="Instrument" required="N" />
<component name="InstrumentExtension" required="N" />
<component name="MarginInfoGrp" required="N" />
<component name="MiscFeesGrp" required="N" />
<component name="OrderQtyData" required="N" />
<component name="PaginationCtrl" required="N" />
<component name="Parties" required="N" />
<component name="SpreadOrBenchmarkCurveData" required="N" />
<component name="Stipulations" required="N" />
<component name="StubGrp" required="N" />
<component name="UndInstrmtGrp" required="N" />
<component name="YieldData" required="N" />
</message>
<message name="FreeFormatMessage" description="" msgtype="F01" msgcat="app">
  <field name="FreeMsgID" required="N" />
  <field name="FreeMsgType" required="N" />
  <field name="Text" required="N" />
  <field name="TransactTime" required="N" />
</message>
<message name="FundValueRpt" description="" msgtype="U71" msgcat="app">
  <field name="FundValueRptID" required="N" />
  <field name="FundValueRptType" required="N" />
  <field name="QueryRequestID" required="N" />
  <component name="FundValueGrp" required="N" />
  <component name="Parties" required="N" />
</message>
<message name="FundValueRptAck" description="" msgtype="U72" msgcat="app">
  <field name="FundValueRptID" required="N" />
  <field name="FundValueRptStatus" required="N" />
</message>

```

```

<message name="HeartBeat" description="" msgtype="0" msgcat="admin">
  <field name="TestReqID" required="N" />
</message>
<message name="HoldRequest" description="" msgtype="U60" msgcat="app">
  <field name="HoldRequestID" required="N" />
  <field name="OrdType" required="N" />
  <field name="TransactTime" required="N" />
</message>
<message name="IOI" description="" msgtype="6" msgcat="app">
  <field name="AccruedInterestAmt" required="N" />
  <field name="AccruedInterestRate" required="N" />
  <field name="AccruedInterestTotalAmt" required="N" />
  <field name="AnonymousIndicator" required="N" />
  <field name="CalculateAgency" required="N" />
  <field name="CashHoldingDays" required="N" />
  <field name="ClOrdID" required="N" />
  <field name="ConstituentIndicator" required="N" />
  <field name="ContingencyIndicator" required="N" />
  <field name="CouponPaymentDateReset" required="N" />
  <field name="Currency" required="N" />
  <field name="DataCategoryIndicator" required="N" />
  <field name="DayCount" required="N" />
  <field name="DirtyPrice" required="N" />
  <field name="DirtyPrice2" required="N" />
  <field name="DiscountRate" required="N" />
  <field name="DisputeSettlementMethod" required="N" />
  <field name="EffectiveTime" required="N" />
  <field name="EncodedText" required="N" />
  <field name="EncodedTextLen" required="N" />
  <field name="IniExReqIndicator" required="N" />
  <field name="InterestAccuralDaysAdjustment" required="N" />
  <field name="InterestFixDate" required="N" />
  <field name="InterestFixDateAdjustment" required="N" />
  <field name="IOIID" required="N" />
  <field name="IOIQty" required="N" />
  <field name="IOITransType" required="N" />
  <field name="MarginRequired" required="N" />
  <field name="NetGrossInd" required="N" />
  <field name="OrdQtyResetAmount" required="N" />
  <field name="OrdQtyResetDate" required="N" />
  <field name="OrdQtyResetFrequency" required="N" />
  <field name="OrdQtyResetPercentage" required="N" />
  <field name="OrdQtyResetRequired" required="N" />

```

```

<field name="OrdQtyResetType" required="N" />
<field name="Price" required="N" />
<field name="PriceType" required="N" />
<field name="QueryRequestID" required="N" />
<field name="QuoteMethod" required="N" />
<field name="QuoteStatus" required="N" />
<field name="QuoteTime" required="N" />
<field name="QuoteType" required="N" />
<field name="RemarkIndicator" required="N" />
<field name="SecurityHoldingDays" required="N" />
<field name="SendingScope" required="N" />
<field name="SettlCurrAmt" required="N" />
<field name="SettlCurrAmt2" required="N" />
<field name="SettlDate" required="N" />
<field name="SettlDate2" required="N" />
<field name="SettlDateAdjustment" required="N" />
<field name="SettlDateTerm" required="N" />
<field name="SettlType" required="N" />
<field name="Side" required="N" />
<field name="StubIndicator" required="N" />
<field name="TerminationTime" required="N" />
<field name="Text" required="N" />
<field name="TimeInForce" required="N" />
<field name="TradeCashAmt" required="N" />
<field name="TradeDate" required="N" />
<field name="TradeFwdDays" required="N" />
<field name="TradeLimitDays" required="N" />
<field name="TradeMethod" required="N" />
<field name="TradeTime" required="N" />
<field name="TradeType" required="N" />
<field name="TransactTime" required="N" />
<field name="ValidUntilTime" required="N" />
<component name="DeliveryOptionGrp" required="N" />
<component name="FinancingDetails" required="N" />
<component name="GroupGrp" required="N" />
<component name="InitialExGrp" required="N" />
<component name="InstrmtLegIOIGrp" required="N" />
<component name="Instrument" required="N" />
<component name="MarginInfoGrp" required="N" />
<component name="MiscFeesGrp" required="N" />
<component name="OrderQtyData" required="N" />
<component name="PaginationCtrl" required="N" />
<component name="Parties" required="N" />

```

```

    <component name="RoutingGrp" required="N" />
    <component name="SpreadOrBenchmarkCurveData" required="N" />
    <component name="Stipulations" required="N" />
    <component name="StubGrp" required="N" />
    <component name="UndInstrmtGrp" required="N" />
</message>
<message name="JournalEntry" description="Journal Entry message."
msgtype="A02" msgcat="app">
    <field name="Account" required="N" />
    <field name="AccountAmount" required="N" />
    <field name="AccountCode" required="N" />
    <field name="AccountDesc" required="N" />
    <field name="BatchCode" required="N" />
    <field name="BundleCode" required="N" />
    <field name="InBalShtIndic" required="N" />
    <field name="JournalEntryID" required="N" />
    <field name="JournalEntryReqID" required="N" />
    <field name="JournalEntryStatus" required="N" />
    <field name="KeepFolder" required="N" />
    <field name="MessageID" required="N" />
    <field name="Password" required="N" />
    <field name="ProcessStatus" required="N" />
    <field name="SettlDate" required="N" />
    <field name="Side" required="N" />
    <field name="Text" required="N" />
    <field name="TransactTime" required="N" />
    <field name="Username" required="N" />
    <component name="PaginationCtrl" required="N" />
    <component name="Parties" required="N" />
</message>
<message name="JournalEntryAck" description="Journal Entry Acknowledgment."
msgtype="A03" msgcat="app">
    <field name="JournalEntryID" required="N" />
    <field name="JournalEntryStatus" required="N" />
    <field name="MessageID" required="N" />
    <field name="Text" required="N" />
</message>
<message name="JournalEntryRequest" description="Journal entry request
message." msgtype="A01" msgcat="app">
    <field name="Account" required="N" />
    <field name="AccountCode" required="N" />
    <field name="BatchCode" required="N" />
    <field name="JournalEntryReqID" required="N" />

```

```

<field name="KeepFolder" required="N" />
<field name="Password" required="N" />
<field name="SettlDate" required="N" />
<field name="Username" required="N" />
</message>
<message name="LimitInfo" description="" msgtype="U26" msgcat="app">
  <field name="LastRptRequested" required="N" />
  <field name="LimitInfoID" required="N" />
  <field name="LimitTransType" required="N" />
  <field name="QueryRequestID" required="N" />
  <field name="TransactTime" required="N" />
  <component name="LimitInfoGrp" required="N" />
</message>
<message name="LimitInfoAck" description="" msgtype="U70" msgcat="app">
  <field name="LimitInfoID" required="N" />
  <field name="LimitInfoStatus" required="N" />
  <field name="Text" required="N" />
  <field name="TransactTime" required="N" />
</message>
<message name="Logon" description="" msgtype="A" msgcat="admin">
  <field name="EncryptMethod" required="N" />
  <field name="EntitySerialNum" required="N" />
  <field name="HeartBtInt" required="N" />
  <field name="MaxMessageSize" required="N" />
  <field name="NewPassword" required="N" />
  <field name="NextExpectedMsgSeqNum" required="N" />
  <field name="NextSystemSeqNo" required="N" />
  <field name="NextUserSeqNo" required="N" />
  <field name="Password" required="N" />
  <field name="PrivilegeNo" required="N" />
  <field name="PutOrCallDueDate" required="N" />
  <field name="PwdExpiryFlag" required="N" />
  <field name="RawData" required="N" />
  <field name="RawDataLength" required="N" />
  <field name="ResetSeqNumFlag" required="N" />
  <field name="SessionStatus" required="N" />
  <field name="SoftwareType" required="N" />
  <field name="TestMessageIndicator" required="N" />
  <field name="Text" required="N" />
  <field name="TradingSessionID" required="N" />
  <field name="Username" required="N" />
  <field name="VersionNo" required="N" />
</message>

```

```

<message name="Logout" description="" msgtype="5" msgcat="admin">
  <field name="EncodedText" required="N" />
  <field name="EncodedTextLen" required="N" />
  <field name="LogoutStatus" required="N" />
  <field name="SessionStatus" required="N" />
  <field name="Text" required="N" />
  <field name="Username" required="N" />
</message>
<message name="MarketDataAck" description="" msgtype="U74" msgcat="app">
  <field name="MDReportID" required="N" />
  <field name="TransactTime" required="N" />
</message>
<message name="MarketDataIncrementalRefresh" description="" msgtype="X"
msgcat="app">
  <field name="DownloadedDataType" required="N" />
  <field name="DownloadRequestID" required="N" />
  <field name="EncodedText" required="N" />
  <field name="EncodedTextLen" required="N" />
  <field name="ExecID" required="N" />
  <field name="IssueTime" required="N" />
  <field name="MarketDataCancel" required="N" />
  <field name="QuoteTime" required="N" />
  <field name="Text" required="N" />
  <field name="TransactTime" required="N" />
  <field name="UniqueOutputKey" required="N" />
  <component name="LiquidProviderGrp" required="N" />
  <component name="MDTypeGrp" required="N" />
</message>
<message name="MarketDataRequest" description="" msgtype="V" msgcat="app">
  <field name="ContinueBroadcast" required="N" />
  <field name="MDReqID" required="N" />
  <field name="RecoveryAdjustment" required="N" />
  <field name="RecoveryFromTime" required="N" />
  <field name="SubscriptionRequestType" required="N" />
  <field name="TransactTime" required="N" />
  <field name="UniqueOutputKey" required="N" />
  <component name="MDReqGrp" required="N" />
</message>
<message name="MarketDataSnapshotFullRefresh" description="" msgtype="W"
msgcat="app">
  <field name="BenchmarkEffectiveDate" required="N" />
  <field name="DataSourceString" required="N" />
  <field name="DelayPeriod" required="N" />

```

```

<field name="DownloadedDataType" required="N" />
<field name="DownloadRequestID" required="N" />
<field name="EncodedText" required="N" />
<field name="EncodedTextLen" required="N" />
<field name="ExecID" required="N" />
<field name="IssueTime" required="N" />
<field name="MarketDataCancel" required="N" />
<field name="MDReportID" required="N" />
<field name="MDReqID" required="N" />
<field name="QuoteTime" required="N" />
<field name="SnapshotInterval" required="N" />
<field name="Text" required="N" />
<field name="TradeDate" required="N" />
<field name="TransactTime" required="N" />
<field name="UniqueOutputKey" required="N" />
<component name="LiquidProviderGrp" required="N" />
<component name="MDTypeGrp" required="N" />
</message>
<message name="MassQuote" description="" msgtype="i" msgcat="app">
  <field name="TermToMaturity" required="N" />
  <field name="TransactTime" required="N" />
  <component name="QuotSetGrp" required="N" />
</message>
<message name="MassTrdReport" description="" msgtype="U16" msgcat="app">
  <field name="TradeReportID" required="N" />
  <field name="TransactTime" required="N" />
  <component name="TrdRptGrp" required="N" />
</message>
<message name="MassTrdReportAck" description="" msgtype="U17" msgcat="app">
  <field name="Text" required="N" />
  <field name="TradeReportID" required="N" />
  <field name="TradeReportRejectReason" required="N" />
  <field name="TransactTime" required="N" />
  <field name="TrdRptStatus" required="N" />
</message>
<message name="NewOrderMultileg" description="" msgtype="AB" msgcat="app">
  <field name="AutoTraderPickup" required="N" />
  <field name="BaseAmountDPS" required="N" />
  <field name="BidSpotRate" required="N" />
  <field name="ClOrdID" required="N" />
  <field name="Currency" required="N" />
  <field name="DecimalPlaces" required="N" />
  <field name="ExpireDate" required="N" />

```

```

<field name="ExpireTime" required="N" />
<field name="ForwardScaleDecimalPlaces" required="N" />
<field name="FWDecimalPlaces" required="N" />
<field name="InCompetition" required="N" />
<field name="OfferSpotRate" required="N" />
<field name="OrderID" required="N" />
<field name="OrdStatus" required="N" />
<field name="OrdType" required="N" />
<field name="QuoteID" required="N" />
<field name="Reference" required="N" />
<field name="RiskCurrency" required="N" />
<field name="RiskLastQty" required="N" />
<field name="RoundDownCurrencies" required="N" />
<field name="Side" required="N" />
<field name="SpotRate" required="N" />
<field name="TermAmountDPS" required="N" />
<field name="Text" required="N" />
<field name="TimeInForce" required="N" />
<field name="TimeToLive" required="N" />
<field name="TradeInstrument" required="N" />
<field name="TransactTime" required="N" />
<component name="Instrument" required="N" />
<component name="LegOrdGrp" required="N" />
<component name="Parties" required="N" />
</message>
<message name="NewOrderSingle" description="" msgtype="D" msgcat="app">
  <field name="AccruedInterestAmt" required="N" />
  <field name="AccruedInterestRate" required="N" />
  <field name="AccruedInterestTotalAmt" required="N" />
  <field name="AnonymousIndicator" required="N" />
  <field name="AutoTraderPickup" required="N" />
  <field name="BaseAmountDPS" required="N" />
  <field name="BidForwardPoints" required="N" />
  <field name="BidPx" required="N" />
  <field name="BidSpotRate" required="N" />
  <field name="CalculatedCcyLastQty" required="N" />
  <field name="CashHoldingDays" required="N" />
  <field name="CashPaymentType" required="N" />
  <field name="ClOrdID" required="N" />
  <field name="ContingencyIndicator" required="N" />
  <field name="Currency" required="N" />
  <field name="DataCategoryIndicator" required="N" />
  <field name="DayCount" required="N" />

```



```
<field name="DecimalPlaces" required="N" />
<field name="DirtyPrice" required="N" />
<field name="DirtyPrice2" required="N" />
<field name="DiscountRate" required="N" />
<field name="DisputeSettlementMethod" required="N" />
<field name="EffectiveTime" required="N" />
<field name="EncodedText" required="N" />
<field name="EncodedTextLen" required="N" />
<field name="ExecID" required="N" />
<field name="ExecInst" required="N" />
<field name="ExpireDate" required="N" />
<field name="ExpireTime" required="N" />
<field name="ForwardPoints" required="N" />
<field name="ForwardScaleDecimalPlaces" required="N" />
<field name="FWDecimalPlaces" required="N" />
<field name="InCompetition" required="N" />
<field name="IniExReqIndicator" required="N" />
<field name="InterestFixDate" required="N" />
<field name="InterestFixDateAdjustment" required="N" />
<field name="LastQty" required="N" />
<field name="LeavesTotalQty" required="N" />
<field name="LimitOrderSubType" required="N" />
<field name="MarginRequired" required="N" />
<field name="MaxFloor" required="N" />
<field name="MaxQty" required="N" />
<field name="MinQty" required="N" />
<field name="MinTickSize" required="N" />
<field name="NDFCurrency" required="N" />
<field name="NDFDate" required="N" />
<field name="NegotiationCount" required="N" />
<field name="NetGrossInd" required="N" />
<field name="OfferForwardPoints" required="N" />
<field name="OfferPx" required="N" />
<field name="OfferSpotRate" required="N" />
<field name="OrderEntryTime" required="N" />
<field name="OrderID" required="N" />
<field name="OrdQtyResetAmount" required="N" />
<field name="OrdQtyResetDate" required="N" />
<field name="OrdQtyResetFrequency" required="N" />
<field name="OrdQtyResetPercentage" required="N" />
<field name="OrdQtyResetRequired" required="N" />
<field name="OrdQtyResetType" required="N" />
<field name="OrdStatus" required="N" />
```

```
<field name="OrdType" required="N" />
<field name="ParentOrderID" required="N" />
<field name="Price" required="N" />
<field name="PriceType" required="N" />
<field name="QueryRequestID" required="N" />
<field name="QuoteID" required="N" />
<field name="QuoteRespID" required="N" />
<field name="QuoteTime" required="N" />
<field name="QuoteType" required="N" />
<field name="Reference" required="N" />
<field name="RemarkIndicator" required="N" />
<field name="RiskCurrency" required="N" />
<field name="RiskLastQty" required="N" />
<field name="RoundDownCurrencies" required="N" />
<field name="SettlCurrAmt" required="N" />
<field name="SettlCurrAmt2" required="N" />
<field name="SettlCurrency" required="N" />
<field name="SettlCurrency2" required="N" />
<field name="SettlDate" required="N" />
<field name="SettlDate2" required="N" />
<field name="SettlDateAdjustment" required="N" />
<field name="SettlResetDate" required="N" />
<field name="SettlType" required="N" />
<field name="Side" required="N" />
<field name="SpotDate" required="N" />
<field name="SpotRate" required="N" />
<field name="StopPx" required="N" />
<field name="StubIndicator" required="N" />
<field name="SupplementaryClause" required="N" />
<field name="TermAmountDPS" required="N" />
<field name="TerminationTime" required="N" />
<field name="Text" required="N" />
<field name="TimeInForce" required="N" />
<field name="TimeToLive" required="N" />
<field name="TradeCashAmt" required="N" />
<field name="TradeCashSpread" required="N" />
<field name="TradeFwdDays" required="N" />
<field name="TradeInstrument" required="N" />
<field name="TradeLimitDays" required="N" />
<field name="TradeMethod" required="N" />
<field name="TradeTime" required="N" />
<field name="TradeType" required="N" />
<field name="TradingSessionID" required="N" />
```

```

<field name="TransactTime" required="N" />
<field name="Turnover" required="N" />
<field name="ValidDays" required="N" />
<field name="ValidUntilDate" required="N" />
<field name="ValidUntilTime" required="N" />
<component name="DeliveryOptionGrp" required="N" />
<component name="FinancingDetails" required="N" />
<component name="GroupGrp" required="N" />
<component name="Instrument" required="N" />
<component name="MarginInfoGrp" required="N" />
<component name="MiscFeesGrp" required="N" />
<component name="OrderQtyData" required="N" />
<component name="PaginationCtrl" required="N" />
<component name="Parties" required="N" />
<component name="RoutingGrp" required="N" />
<component name="SpreadOrBenchmarkCurveData" required="N" />
<component name="Stipulations" required="N" />
<component name="StubGrp" required="N" />
<component name="UndInstrmtGrp" required="N" />
</message>
<message name="OrdDisplay" description="" msgtype="U18" msgcat="app">
  <field name="DisplayType" required="N" />
  <field name="TransactTime" required="N" />
  <component name="Instrument" required="N" />
  <component name="LegOrdGrp" required="N" />
  <component name="LegParties" required="N" />
  <component name="MMSetGrp" required="N" />
</message>
<message name="OrderCancelReject" description="" msgtype="9" msgcat="app">
  <field name="C1OrdID" required="N" />
  <field name="EncodedText" required="N" />
  <field name="EncodedTextLen" required="N" />
  <field name="MarketIndicator" required="N" />
  <field name="OrderID" required="N" />
  <field name="OrdStatus" required="N" />
  <field name="OrdType" required="N" />
  <field name="Price" required="N" />
  <field name="Side" required="N" />
  <field name="Text" required="N" />
  <field name="TradingSessionID" required="N" />
  <field name="TransactTime" required="N" />
</message>
<message name="OrderCancelReplaceRequest" description="" msgtype="G"

```

```
msgcat="app">
  <field name="AccruedInterestAmt" required="N" />
  <field name="AccruedInterestRate" required="N" />
  <field name="AccruedInterestTotalAmt" required="N" />
  <field name="AnonymousIndicator" required="N" />
  <field name="CashHoldingDays" required="N" />
  <field name="CashPaymentType" required="N" />
  <field name="ClOrdID" required="N" />
  <field name="ContingencyIndicator" required="N" />
  <field name="Currency" required="N" />
  <field name="DayCount" required="N" />
  <field name="DirtyPrice" required="N" />
  <field name="DirtyPrice2" required="N" />
  <field name="DisputeSettlementMethod" required="N" />
  <field name="EffectiveTime" required="N" />
  <field name="EncodedText" required="N" />
  <field name="EncodedTextLen" required="N" />
  <field name="ExecID" required="N" />
  <field name="ExecInst" required="N" />
  <field name="ExecType" required="N" />
  <field name="ExpireDate" required="N" />
  <field name="ExpireTime" required="N" />
  <field name="InterestAccuralDaysAdjustment" required="N" />
  <field name="InterestFixDate" required="N" />
  <field name="InterestFixDateAdjustment" required="N" />
  <field name="LeavesTotalQty" required="N" />
  <field name="MarginRequired" required="N" />
  <field name="MaxFloor" required="N" />
  <field name="MaxQty" required="N" />
  <field name="MinQty" required="N" />
  <field name="MinTickSize" required="N" />
  <field name="NegotiationCount" required="N" />
  <field name="OrderEntryTime" required="N" />
  <field name="OrderID" required="N" />
  <field name="OrdQtyResetAmount" required="N" />
  <field name="OrdQtyResetDate" required="N" />
  <field name="OrdQtyResetFrequency" required="N" />
  <field name="OrdQtyResetPercentage" required="N" />
  <field name="OrdQtyResetRequired" required="N" />
  <field name="OrdQtyResetType" required="N" />
  <field name="OrdStatus" required="N" />
  <field name="OrdType" required="N" />
  <field name="Price" required="N" />
```

```

<field name="PriceType" required="N" />
<field name="QuoteRespID" required="N" />
<field name="RemarkIndicator" required="N" />
<field name="SettlCurrAmt" required="N" />
<field name="SettlCurrAmt2" required="N" />
<field name="SettlCurrency" required="N" />
<field name="SettlCurrency2" required="N" />
<field name="SettlDate" required="N" />
<field name="SettlDate2" required="N" />
<field name="SettlDateAdjustment" required="N" />
<field name="SettlResetDate" required="N" />
<field name="SettlType" required="N" />
<field name="Side" required="N" />
<field name="StopPx" required="N" />
<field name="SupplementaryClause" required="N" />
<field name="TerminationTime" required="N" />
<field name="Text" required="N" />
<field name="TimeInForce" required="N" />
<field name="TradeCashAmt" required="N" />
<field name="TradeCashSpread" required="N" />
<field name="TradeFwdDays" required="N" />
<field name="TradeLimitDays" required="N" />
<field name="TradeMethod" required="N" />
<field name="TradeType" required="N" />
<field name="TradingSessionID" required="N" />
<field name="TransactTime" required="N" />
<field name="Turnover" required="N" />
<field name="ValidDays" required="N" />
<field name="ValidUntilDate" required="N" />
<field name="ValidUntilTime" required="N" />
<component name="DeliveryOptionGrp" required="N" />
<component name="FinancingDetails" required="N" />
<component name="Instrument" required="N" />
<component name="MarginInfoGrp" required="N" />
<component name="MiscFeesGrp" required="N" />
<component name="OrderQtyData" required="N" />
<component name="Parties" required="N" />
<component name="SpreadOrBenchmarkCurveData" required="N" />
<component name="Stipulations" required="N" />
<component name="StubGrp" required="N" />
<component name="UndInstrmtGrp" required="N" />
</message>
<message name="OrderCancelRequest" description="" msgtype="F" msgcat="app">

```

```

    <field name="CLOrdID" required="N" />
    <field name="ContingencyIndicator" required="N" />
    <field name="Currency" required="N" />
    <field name="EncodedText" required="N" />
    <field name="EncodedTextLen" required="N" />
    <field name="OrderID" required="N" />
    <field name="OrdStatus" required="N" />
    <field name="OrdType" required="N" />
    <field name="Price" required="N" />
    <field name="Side" required="N" />
    <field name="Text" required="N" />
    <field name="TradeMethod" required="N" />
    <field name="TransactTime" required="N" />
    <component name="Instrument" required="N" />
    <component name="Parties" required="N" />
</message>
<message name="OrderStatusRequest" description="" msgtype="H" msgcat="app">
    <field name="CLOrdID" required="N" />
    <field name="OrderID" required="N" />
    <field name="OrdStatusReqID" required="N" />
    <field name="OrdStatusReqType" required="N" />
    <field name="OrdType" required="N" />
    <field name="TransactTime" required="N" />
</message>
<message name="PartyDetailsListReport" description="" msgtype="CG"
msgcat="app">
    <field name="PartyDetailsListReportID" required="N" />
    <field name="PartyDetailsListRequestID" required="N" />
    <field name="PartyInfoType" required="N" />
    <field name="TotNoPartyList" required="N" />
    <field name="TradeDate" required="N" />
    <field name="TransactTime" required="N" />
    <component name="PaginationCtrl" required="N" />
    <component name="PartyListGrp" required="N" />
</message>
<message name="PartyDetailsListRequest" description="" msgtype="CF"
msgcat="app">
    <field name="PartyDetailsListRequestID" required="N" />
    <field name="PartyInfoType" required="N" />
    <field name="TransactTime" required="N" />
</message>
<message name="PartyInfo" description="" msgtype="U22" msgcat="app">
    <field name="PartyInfoID" required="N" />

```

```

<field name="PartyInfoType" required="N" />
<field name="PartyTransType" required="N" />
<field name="QueryRequestID" required="N" />
<field name="TransactTime" required="N" />
<component name="GroupGrp" required="N" />
<component name="Parties" required="N" />
</message>
<message name="PartyInfoAck" description="" msgtype="U39" msgcat="app">
  <field name="PartyDetailsListReportID" required="N" />
  <field name="PartyInfoID" required="N" />
  <field name="PartyInfoStatus" required="N" />
  <field name="PartyInfoType" required="N" />
  <field name="Text" required="N" />
  <field name="TransactTime" required="N" />
</message>
<message name="PositionReport" description="" msgtype="AP" msgcat="app">
  <field name="PosMaintRptID" required="N" />
  <field name="PosReqType" required="N" />
  <field name="ProductComplex" required="N" />
  <field name="SecurityType" required="N" />
  <component name="Parties" required="N" />
  <component name="PositionAmountData" required="N" />
</message>
<message name="QueryReject" description="" msgtype="U04" msgcat="app">
  <field name="LimitInfoType" required="N" />
  <field name="QueryRejectReason" required="N" />
  <field name="QueryRequestID" required="N" />
  <field name="QueryType" required="N" />
  <field name="RatioType" required="N" />
  <field name="TransactTime" required="N" />
</message>
<message name="QueryRequest" description="" msgtype="U02" msgcat="app">
  <field name="CNYTradedIndic" required="N" />
  <field name="DBDDLStatement" required="N" />
  <field name="DBSQLStatement" required="N" />
  <field name="ExecID" required="N" />
  <field name="InquiryLayer" required="N" />
  <field name="IOIID" required="N" />
  <field name="LimitInfoType" required="N" />
  <field name="LimitType" required="N" />
  <field name="MarginAgency" required="N" />
  <field name="OrderID" required="N" />
  <field name="QueryDataBaseName" required="N" />

```

```

<field name="QueryDBSchemaName" required="N" />
<field name="QueryDBTableName" required="N" />
<field name="QueryDBTimeFormat" required="N" />
<field name="QueryDBViewName" required="N" />
<field name="QueryEndDate" required="N" />
<field name="QueryEndExecID" required="N" />
<field name="QueryEndSettlDate" required="N" />
<field name="QueryEndTime" required="N" />
<field name="QueryExecType" required="N" />
<field name="QueryMaxFwdTerm" required="N" />
<field name="QueryMaxTerm" required="N" />
<field name="QueryMinFwdTerm" required="N" />
<field name="QueryMinTerm" required="N" />
<field name="QueryOrdStatus" required="N" />
<field name="QueryPageNumber" required="N" />
<field name="QueryPageSize" required="N" />
<field name="QueryQuoteType" required="N" />
<field name="QueryRequestID" required="N" />
<field name="QueryStartDate" required="N" />
<field name="QueryStartNumber" required="N" />
<field name="QueryStartSettlDate" required="N" />
<field name="QueryStartTime" required="N" />
<field name="QueryType" required="N" />
<field name="QuoteID" required="N" />
<field name="RatioType" required="N" />
<field name="RecoveryAdjustment" required="N" />
<field name="RecoveryFromTime" required="N" />
<field name="Side" required="N" />
<field name="TradeInstrument" required="N" />
<field name="TradeMethod" required="N" />
<field name="TradeType" required="N" />
<field name="TransactTime" required="N" />
<field name="UniqueOutputKey" required="N" />
<component name="BenchmarkGrp" required="N" />
<component name="Instrument" required="N" />
<component name="Parties" required="N" />
<component name="QueryParamGrp" required="N" />
<component name="SpreadOrBenchmarkCurveData" required="N" />
<component name="UndInstrmtGrp" required="N" />
</message>
<message name="QueryResult" description="" msgtype="U01" msgcat="app">
  <field name="Currency" required="N" />

```



```

<field name="DBDDLStatement" required="N" />
<field name="DBSQLResultCols" required="N" />
<field name="DBSQLStatement" required="N" />
<field name="DBTime" required="N" />
<field name="ExecID" required="N" />
<field name="LimitInfoType" required="N" />
<field name="LimitType" required="N" />
<field name="MarginRequired" required="N" />
<field name="QueryDataBaseName" required="N" />
<field name="QueryDBSchemaName" required="N" />
<field name="QueryDBTableColName" required="N" />
<field name="QueryDBTableName" required="N" />
<field name="QueryDBTimeFormat" required="N" />
<field name="QueryDBViewName" required="N" />
<field name="QueryRequestID" required="N" />
<field name="QueryStartNumber" required="N" />
<field name="QueryTime" required="N" />
<field name="QueryType" required="N" />
<field name="RatioType" required="N" />
<field name="SettlCurrAmt" required="N" />
<field name="TotalDealCount" required="N" />
<field name="TotalValidDealCount" required="N" />
<field name="TradeCashAmt" required="N" />
<field name="TradeDate" required="N" />
<field name="TransactTime" required="N" />
<component name="DBCharacterSetsGrp" required="N" />
<component name="DBNameGrp" required="N" />
<component name="DBSchemaGrp" required="N" />
<component name="DBTableColGrp" required="N" />
<component name="DBTableGrp" required="N" />
<component name="DBViewGrp" required="N" />
<component name="FinancingDetails" required="N" />
<component name="Instrument" required="N" />
<component name="MarginInfoGrp" required="N" />
<component name="MiscFeesGrp" required="N" />
<component name="OrderQtyData" required="N" />
<component name="PaginationCtrl" required="N" />
<component name="Parties" required="N" />
<component name="QueryResultGrp" required="N" />
<component name="RatioDataGrp" required="N" />
<component name="SpreadOrBenchmarkCurveData" required="N" />
</message>
<message name="QuickCancel" description="" msgtype="U20" msgcat="app">

```

```

    <field name="QuoteType" required="N" />
    <field name="Side" required="N" />
    <field name="Text" required="N" />
    <field name="TradeMethod" required="N" />
    <field name="TransactTime" required="N" />
    <component name="Instrument" required="N" />
    <component name="Parties" required="N" />
</message>
<message name="QuickCancelStatusReport" description="" msgtype="U21"
msgcat="app">
    <field name="QuoteType" required="N" />
    <field name="Side" required="N" />
    <field name="TradeMethod" required="N" />
    <field name="TransactTime" required="N" />
    <component name="Instrument" required="N" />
    <component name="Parties" required="N" />
</message>
<message name="Quote" description="" msgtype="S" msgcat="app">
    <field name="AccruedInterestAmt" required="N" />
    <field name="AccruedInterestRate" required="N" />
    <field name="AccruedInterestTotalAmt" required="N" />
    <field name="AnonymousIndicator" required="N" />
    <field name="AutoQuoteIndicator" required="N" />
    <field name="AutoTradable" required="N" />
    <field name="BaseAmountDPS" required="N" />
    <field name="BidForwardPoints" required="N" />
    <field name="BidPx" required="N" />
    <field name="BidSpotRate" required="N" />
    <field name="CalculateAgency" required="N" />
    <field name="CalculatedCcyLastQty" required="N" />
    <field name="CashHoldingDays" required="N" />
    <field name="CashPaymentType" required="N" />
    <field name="ClOrdID" required="N" />
    <field name="ConstituentIndicator" required="N" />
    <field name="ContingencyIndicator" required="N" />
    <field name="CouponPaymentDateReset" required="N" />
    <field name="Currency" required="N" />
    <field name="DataCategoryIndicator" required="N" />
    <field name="DataSourceString" required="N" />
    <field name="DayCount" required="N" />
    <field name="DecimalPlaces" required="N" />
    <field name="DirtyPrice" required="N" />
    <field name="DirtyPrice2" required="N" />

```

```
<field name="DiscountRate" required="N" />
<field name="DisputeSettlementMethod" required="N" />
<field name="DownloadedDataType" required="N" />
<field name="DownloadRequestID" required="N" />
<field name="EffectiveTime" required="N" />
<field name="EncodedText" required="N" />
<field name="EncodedTextLen" required="N" />
<field name="ExecID" required="N" />
<field name="ExpireDate" required="N" />
<field name="ExpireTime" required="N" />
<field name="ForwardScaleDecimalPlaces" required="N" />
<field name="FWDecimalPlaces" required="N" />
<field name="InCompetition" required="N" />
<field name="IniExReqIndicator" required="N" />
<field name="InterestAccuralDaysAdjustment" required="N" />
<field name="InterestFixDate" required="N" />
<field name="InterestFixDateAdjustment" required="N" />
<field name="LastModifyTime" required="N" />
<field name="LastQty" required="N" />
<field name="LeavesTotalQty" required="N" />
<field name="MarginRequired" required="N" />
<field name="MaxFloor" required="N" />
<field name="MaxQty" required="N" />
<field name="MinQty" required="N" />
<field name="MinTickSize" required="N" />
<field name="NDFCurrency" required="N" />
<field name="NDFDate" required="N" />
<field name="NegotiationCount" required="N" />
<field name="NetGrossInd" required="N" />
<field name="OfferForwardPoints" required="N" />
<field name="OfferPx" required="N" />
<field name="OfferSpotRate" required="N" />
<field name="OrderEntryTime" required="N" />
<field name="OrdQtyResetAmount" required="N" />
<field name="OrdQtyResetDate" required="N" />
<field name="OrdQtyResetFrequency" required="N" />
<field name="OrdQtyResetPercentage" required="N" />
<field name="OrdQtyResetRequired" required="N" />
<field name="OrdQtyResetType" required="N" />
<field name="Price" required="N" />
<field name="PriceType" required="N" />
<field name="QueryRequestID" required="N" />
<field name="QuoteID" required="N" />
```

```
<field name="QuoteMethod" required="N" />
<field name="QuoteMode" required="N" />
<field name="QuoteReqID" required="N" />
<field name="QuoteRespID" required="N" />
<field name="QuoteSN" required="N" />
<field name="QuoteStatus" required="N" />
<field name="QuoteTime" required="N" />
<field name="QuoteTransType" required="N" />
<field name="QuoteType" required="N" />
<field name="QuoteWindow" required="N" />
<field name="Reference" required="N" />
<field name="RemarkIndicator" required="N" />
<field name="RiskCurrency" required="N" />
<field name="RiskLastQty" required="N" />
<field name="RoundDownCurrencies" required="N" />
<field name="SecurityHoldingDays" required="N" />
<field name="SendingScope" required="N" />
<field name="SettlCurrAmt" required="N" />
<field name="SettlCurrAmt2" required="N" />
<field name="SettlCurrency" required="N" />
<field name="SettlCurrency2" required="N" />
<field name="SettlDate" required="N" />
<field name="SettlDate2" required="N" />
<field name="SettlDateAdjustment" required="N" />
<field name="SettlDateTerm" required="N" />
<field name="SettlResetDate" required="N" />
<field name="SettlType" required="N" />
<field name="Side" required="N" />
<field name="SpotDate" required="N" />
<field name="StopPx" required="N" />
<field name="StubIndicator" required="N" />
<field name="SupplementaryClause" required="N" />
<field name="TermAmountDPS" required="N" />
<field name="TerminationTime" required="N" />
<field name="Text" required="N" />
<field name="TimeToLive" required="N" />
<field name="TradeCashAmt" required="N" />
<field name="TradeCashSpread" required="N" />
<field name="TradeDate" required="N" />
<field name="TradeFwdDays" required="N" />
<field name="TradeInstrument" required="N" />
<field name="TradeLimitDays" required="N" />
<field name="TradeMethod" required="N" />
```

```

<field name="TradeTime" required="N" />
<field name="TradeType" required="N" />
<field name="TradingSessionID" required="N" />
<field name="TransactTime" required="N" />
<field name="Turnover" required="N" />
<field name="ValidDays" required="N" />
<field name="ValidUntilDate" required="N" />
<field name="ValidUntilTime" required="N" />
<component name="DeliveryOptionGrp" required="N" />
<component name="DisplayInstruction" required="N" />
<component name="FinancingDetails" required="N" />
<component name="GroupGrp" required="N" />
<component name="InitialExGrp" required="N" />
<component name="Instrument" required="N" />
<component name="LegQuotGrp" required="N" />
<component name="MarginInfoGrp" required="N" />
<component name="MiscFeesGrp" required="N" />
<component name="OrderQtyData" required="N" />
<component name="PaginationCtrl" required="N" />
<component name="Parties" required="N" />
<component name="RoutingGrp" required="N" />
<component name="SpreadOrBenchmarkCurveData" required="N" />
<component name="Stipulations" required="N" />
<component name="StubGrp" required="N" />
<component name="UndInstrmtGrp" required="N" />
</message>
<message name="QuoteAck" description="" msgtype="U30" msgcat="app">
  <field name="ClOrdID" required="N" />
  <field name="QuoteID" required="N" />
  <field name="QuoteMode" required="N" />
  <field name="QuoteReqID" required="N" />
  <field name="QuoteStatus" required="N" />
  <field name="Text" required="N" />
  <field name="TransactTime" required="N" />
  <component name="Instrument" required="N" />
</message>
<message name="QuoteCancel" description="" msgtype="Z" msgcat="app">
  <field name="ClOrdID" required="N" />
  <field name="ContingencyIndicator" required="N" />
  <field name="Currency" required="N" />
  <field name="EncodedText" required="N" />
  <field name="EncodedTextLen" required="N" />
  <field name="Price" required="N" />

```

```

<field name="QuoteID" required="N" />
<field name="QuoteReqID" required="N" />
<field name="QuoteRespID" required="N" />
<field name="QuoteStatus" required="N" />
<field name="QuoteTime" required="N" />
<field name="QuoteTransType" required="N" />
<field name="QuoteType" required="N" />
<field name="Side" required="N" />
<field name="Text" required="N" />
<field name="TradeMethod" required="N" />
<field name="TradeType" required="N" />
<field name="TradingSessionID" required="N" />
<field name="TransactTime" required="N" />
<field name="ValidUntilTime" required="N" />
<component name="Instrument" required="N" />
<component name="LegQuotGrp" required="N" />
<component name="Parties" required="N" />
</message>
<message name="QuoteRequest" description="" msgtype="R" msgcat="app">
  <field name="AskPriceMax" required="N" />
  <field name="AskPriceMin" required="N" />
  <field name="AutoTraderPickup" required="N" />
  <field name="BidPriceMax" required="N" />
  <field name="BidPriceMin" required="N" />
  <field name="ClOrdID" required="N" />
  <field name="DecimalPlaces" required="N" />
  <field name="FWDecimalPlaces" required="N" />
  <field name="InCompetition" required="N" />
  <field name="MRFQId" required="N" />
  <field name="QuoteReqID" required="N" />
  <field name="QuoteRequestType" required="N" />
  <field name="QuoteWindow" required="N" />
  <field name="SettlDate" required="N" />
  <field name="Text" required="N" />
  <field name="TradeInstrument" required="N" />
  <field name="TransactTime" required="N" />
  <field name="VolumeMax" required="N" />
  <field name="VolumeMin" required="N" />
  <component name="Instrument" required="N" />
  <component name="QuotReqGrp" required="N" />
</message>
<message name="QuoteRequestAck" description="" msgtype="U29" msgcat="app">
  <field name="AutoTraderPickup" required="N" />

```

```

    <field name="QuoteReqID" required="N" />
    <field name="TransactTime" required="N" />
    <component name="Parties" required="N" />
</message>
<message name="QuoteRequestCancel" description="" msgtype="U32"
msgcat="app">
    <field name="QuoteReqID" required="N" />
    <field name="Text" required="N" />
    <field name="TransactTime" required="N" />
</message>
<message name="QuoteRequestReject" description="" msgtype="AG" msgcat="app">
    <field name="QuoteReqID" required="N" />
    <field name="Text" required="N" />
    <field name="TransactTime" required="N" />
</message>
<message name="QuoteResponse" description="" msgtype="AJ" msgcat="app">
    <field name="AccruedInterestAmt" required="N" />
    <field name="AccruedInterestRate" required="N" />
    <field name="AccruedInterestTotalAmt" required="N" />
    <field name="AnonymousIndicator" required="N" />
    <field name="CalculateAgency" required="N" />
    <field name="CashHoldingDays" required="N" />
    <field name="CashPaymentType" required="N" />
    <field name="ClOrdID" required="N" />
    <field name="ContingencyIndicator" required="N" />
    <field name="CouponPaymentDateReset" required="N" />
    <field name="Currency" required="N" />
    <field name="DayCount" required="N" />
    <field name="DirtyPrice" required="N" />
    <field name="DirtyPrice2" required="N" />
    <field name="DiscountRate" required="N" />
    <field name="DisplayQty" required="N" />
    <field name="DisputeSettlementMethod" required="N" />
    <field name="EffectiveTime" required="N" />
    <field name="EncodedText" required="N" />
    <field name="EncodedTextLen" required="N" />
    <field name="ExpireDate" required="N" />
    <field name="ExpireTime" required="N" />
    <field name="IniExReqIndicator" required="N" />
    <field name="InterestAccrualDaysAdjustment" required="N" />
    <field name="InterestFixDate" required="N" />
    <field name="InterestFixDateAdjustment" required="N" />
    <field name="IOIID" required="N" />

```

```
<field name="LeavesTotalQty" required="N" />
<field name="MarginRequired" required="N" />
<field name="MaxFloor" required="N" />
<field name="MaxQty" required="N" />
<field name="MinQty" required="N" />
<field name="MinTickSize" required="N" />
<field name="NegotiationCount" required="N" />
<field name="OrderEntryTime" required="N" />
<field name="OrdQtyResetAmount" required="N" />
<field name="OrdQtyResetDate" required="N" />
<field name="OrdQtyResetFrequency" required="N" />
<field name="OrdQtyResetPercentage" required="N" />
<field name="OrdQtyResetRequired" required="N" />
<field name="OrdQtyResetType" required="N" />
<field name="Price" required="N" />
<field name="PriceType" required="N" />
<field name="QuoteID" required="N" />
<field name="QuoteMethod" required="N" />
<field name="QuoteReqID" required="N" />
<field name="QuoteRespID" required="N" />
<field name="QuoteRespType" required="N" />
<field name="QuoteStatus" required="N" />
<field name="QuoteTime" required="N" />
<field name="QuoteTransType" required="N" />
<field name="QuoteType" required="N" />
<field name="ReasonType" required="N" />
<field name="RemarkIndicator" required="N" />
<field name="RICName" required="N" />
<field name="SecurityHoldingDays" required="N" />
<field name="SendingScope" required="N" />
<field name="SettlCurrAmt" required="N" />
<field name="SettlCurrAmt2" required="N" />
<field name="SettlCurrency" required="N" />
<field name="SettlCurrency2" required="N" />
<field name="SettlDate" required="N" />
<field name="SettlDate2" required="N" />
<field name="SettlDateAdjustment" required="N" />
<field name="SettlDateTerm" required="N" />
<field name="SettlResetDate" required="N" />
<field name="SettlType" required="N" />
<field name="Side" required="N" />
<field name="StopPx" required="N" />
<field name="StubIndicator" required="N" />
```



```

<field name="SupplementaryClause" required="N" />
<field name="TerminationTime" required="N" />
<field name="Text" required="N" />
<field name="TradeCashAmt" required="N" />
<field name="TradeCashSpread" required="N" />
<field name="TradeDate" required="N" />
<field name="TradeFwdDays" required="N" />
<field name="TradeLimitDays" required="N" />
<field name="TradeMethod" required="N" />
<field name="TradeTime" required="N" />
<field name="TradeType" required="N" />
<field name="TradingSessionID" required="N" />
<field name="TransactTime" required="N" />
<field name="Turnover" required="N" />
<field name="ValidDays" required="N" />
<field name="ValidUntilDate" required="N" />
<field name="ValidUntilTime" required="N" />
<component name="DeliveryOptionGrp" required="N" />
<component name="FinancingDetails" required="N" />
<component name="GroupGrp" required="N" />
<component name="InitialExGrp" required="N" />
<component name="Instrument" required="N" />
<component name="LegQuotGrp" required="N" />
<component name="MarginInfoGrp" required="N" />
<component name="MiscFeesGrp" required="N" />
<component name="OrderQtyData" required="N" />
<component name="Parties" required="N" />
<component name="RoutingGrp" required="N" />
<component name="SpreadOrBenchmarkCurveData" required="N" />
<component name="Stipulations" required="N" />
<component name="StubGrp" required="N" />
<component name="UndInstrmtGrp" required="N" />
</message>
<message name="QuoteStatusReport" description="" msgtype="AI" msgcat="app">
  <field name="ClOrdID" required="N" />
  <field name="ConstituentIndicator" required="N" />
  <field name="ContingencyIndicator" required="N" />
  <field name="Currency" required="N" />
  <field name="EncodedText" required="N" />
  <field name="EncodedTextLen" required="N" />
  <field name="Price" required="N" />
  <field name="QuoteID" required="N" />
  <field name="QuoteRespID" required="N" />

```

```

    <field name="QuoteStatus" required="N" />
    <field name="QuoteStatusReqID" required="N" />
    <field name="QuoteTime" required="N" />
    <field name="QuoteTransType" required="N" />
    <field name="QuoteType" required="N" />
    <field name="Side" required="N" />
    <field name="Text" required="N" />
    <field name="TradeMethod" required="N" />
    <field name="TradeType" required="N" />
    <field name="TradingSessionID" required="N" />
    <field name="TransactTime" required="N" />
    <component name="Instrument" required="N" />
    <component name="LegQuotGrp" required="N" />
    <component name="Parties" required="N" />
    <component name="RoutingGrp" required="N" />
</message>
<message name="QuoteStatusRequest" description="This message is used to
request a quote status report message." msgtype="a" msgcat="app">
    <field name="ClOrdID" required="N" />
    <field name="QuoteID" required="N" />
    <field name="QuoteStatusReqID" required="N" />
    <field name="QuoteType" required="N" />
    <component name="Parties" required="N" />
</message>
<message name="Reject" description="" msgtype="3" msgcat="admin">
    <field name="ClOrdID" required="N" />
    <field name="EncodedText" required="N" />
    <field name="EncodedTextLen" required="N" />
    <field name="RefMsgType" required="N" />
    <field name="RefSeqNum" required="N" />
    <field name="RefTagID" required="N" />
    <field name="SessionRejectReason" required="N" />
    <field name="Text" required="N" />
</message>
<message name="Remider" description="" msgtype="U77" msgcat="app">
    <field name="ReminderDate" required="N" />
    <field name="ReminderEvent" required="N" />
    <field name="ReminderObjectID" required="N" />
    <field name="ReminderObjectName" required="N" />
    <field name="ReminderType" required="N" />
    <field name="Text" required="N" />
</message>
<message name="ResendRequest" description="" msgtype="2" msgcat="admin">

```

```

<field name="BeginSeqNo" required="N" />
<field name="EndSeqNo" required="N" />
<field name="NextSystemSeqNo" required="N" />
<field name="NextUserSeqNo" required="N" />
</message>
<message name="SecListUpdReportAck" description="" msgtype="U38"
msgcat="app">
  <field name="SecurityReportID" required="N" />
  <field name="TransactTime" required="N" />
</message>
<message name="SecurityDefinition" description="" msgtype="d" msgcat="app">
  <field name="AccruedInterestAmt" required="N" />
  <field name="BenchmarkEffectiveDate" required="N" />
  <field name="CalculateAgency" required="N" />
  <field name="CalculateAgencyDesc" required="N" />
  <field name="ConvertIndicator" required="N" />
  <field name="Currency" required="N" />
  <field name="DayCount" required="N" />
  <field name="DecimalPlaces" required="N" />
  <field name="DeliveryDesc" required="N" />
  <field name="ExpectedMaturityDate" required="N" />
  <field name="FeeMethod" required="N" />
  <field name="FundType" required="N" />
  <field name="HaltedPeriodFrom" required="N" />
  <field name="HaltedPeriodReason" required="N" />
  <field name="HaltedPeriodTo" required="N" />
  <field name="Industry" required="N" />
  <field name="InterestAccrualMethod" required="N" />
  <field name="InterestFixDate" required="N" />
  <field name="InterestFixDateAdjustment" required="N" />
  <field name="InterstAllocationMethod" required="N" />
  <field name="IntFixRtAdjmtDesc" required="N" />
  <field name="IssuerShotName" required="N" />
  <field name="LastTradeCashSpread" required="N" />
  <field name="LegalMaturityDate" required="N" />
  <field name="NextValueDate" required="N" />
  <field name="Originator" required="N" />
  <field name="PaymentDate" required="N" />
  <field name="PrincipalPayFrequency" required="N" />
  <field name="ProductComplex" required="N" />
  <field name="PutOrCallDueDate" required="N" />
  <field name="RedemptionIndicator" required="N" />
  <field name="ReissueIndicator" required="N" />

```

```

<field name="RoundOffType" required="N" />
<field name="SecurityReportID" required="N" />
<field name="SecurityStatus" required="N" />
<field name="SettlDate" required="N" />
<field name="Text" required="N" />
<field name="TradingSessionID" required="N" />
<field name="TransactTime" required="N" />
<component name="BusinessParamGrp" required="N" />
<component name="ComplexEvents" required="N" />
<component name="ConvertInfoGrp" required="N" />
<component name="CredtRateAgencyInfoGrp" required="N" />
<component name="EligibilityIndicators" required="N" />
<component name="EvntGrp" required="N" />
<component name="HistoryInfoGrp" required="N" />
<component name="InheritInfo" required="N" />
<component name="Instrument" required="N" />
<component name="InstrumentExtension" required="N" />
<component name="IssuerGrp" required="N" />
<component name="MarginInfoGrp" required="N" />
<component name="MarketGrp" required="N" />
<component name="Parties" required="N" />
<component name="RedemptionInfoGrp" required="N" />
<component name="ReissueInfoGrp" required="N" />
<component name="SecAltIDGrp" required="N" />
<component name="SpreadOrBenchmarkCurveData" required="N" />
<component name="Stipulations" required="N" />
<component name="SwapBondGrp" required="N" />
<component name="UnderwriterInfoGrp" required="N" />
<component name="UndInstrmtGrp" required="N" />
</message>
<message name="SecurityDefinitionAck" description="" msgtype="U75"
msgcat="app">
  <field name="ProductComplex" required="N" />
  <field name="SecurityDefinitionStatus" required="N" />
  <field name="SecurityReportID" required="N" />
  <field name="Text" required="N" />
  <component name="Instrument" required="N" />
</message>
<message name="SecurityList" description="" msgtype="y" msgcat="app">
  <field name="SecurityListID" required="N" />
  <field name="SecurityListType" required="N" />
  <field name="SecurityReqID" required="N" />
  <field name="TransactTime" required="N" />

```

```

    <component name="SecListGrp" required="N" />
</message>
<message name="SecurityListAck" description="" msgtype="U69" msgcat="app">
    <field name="SecurityListID" required="N" />
    <field name="TransactTime" required="N" />
</message>
<message name="SecurityListRequest" description="" msgtype="x" msgcat="app">
    <field name="SecurityListRequestType" required="N" />
    <field name="SecurityReqID" required="N" />
    <field name="TransactTime" required="N" />
    <component name="SecListGrp" required="N" />
</message>
<message name="SecurityListRequestAck" description="" msgtype="U68"
msgcat="app">
    <field name="SecurityReqID" required="N" />
    <field name="TransactTime" required="N" />
</message>
<message name="SecurityListUpdateReport" description="" msgtype="BK"
msgcat="app">
    <field name="ClearingBusinessDate" required="N" />
    <field name="SecurityListReqID" required="N" />
    <field name="SecurityReportID" required="N" />
    <field name="SecurityUpdateAction" required="N" />
    <field name="SettlReportStatus" required="N" />
    <field name="SettlReportType" required="N" />
    <field name="Text" required="N" />
    <field name="TotNoRelatedSym" required="N" />
    <field name="TransactTime" required="N" />
    <field name="UpdatedSecurityType" required="N" />
    <component name="SecLstUpdRelSymGrp" required="N" />
</message>
<message name="SecurityListUpdRequest" description="" msgtype="U40"
msgcat="app">
    <field name="SecurityListReqID" required="N" />
    <field name="TransactTime" required="N" />
</message>
<message name="SequenceReset" description="" msgtype="4" msgcat="admin">
    <field name="GapFillFlag" required="N" />
    <field name="NewSeqNo" required="N" />
</message>
<message name="SettlDetailRequest" description="" msgtype="U65"
msgcat="app">
    <field name="ClearingBusinessDate" required="N" />

```

```

    <field name="SettlInstReqID" required="N" />
    <field name="TransactTime" required="N" />
    <component name="Parties" required="N" />
</message>
<message name="SettlementDetailReport" description="" msgtype="U33"
msgcat="app">
    <field name="ClearingBusinessDate" required="N" />
    <field name="DistrictBelongedTo" required="N" />
    <field name="SettlInstReqID" required="N" />
    <field name="SettlObligMsgID" required="N" />
    <field name="SettlReportStatus" required="N" />
    <field name="SettlReportType" required="N" />
    <field name="SettlRepConDtlID" required="N" />
    <field name="SettlRepConInquiryID" required="N" />
    <field name="Text" required="N" />
    <field name="TransactTime" required="N" />
    <component name="SettlCurrGrp" required="N" />
    <component name="SettlCurrPairsGrp" required="N" />
</message>
<message name="SettlementDetailReportAck" description="" msgtype="U34"
msgcat="app">
    <field name="SettlObligMsgID" required="N" />
    <field name="SettlRepConDtlID" required="N" />
    <field name="TransactTime" required="N" />
</message>
<message name="SettlementInstructionRequest" description="" msgtype="AV"
msgcat="app">
    <field name="ClearingBusinessDate" required="N" />
    <field name="CNYTradedIndic" required="N" />
    <field name="EffectiveTime" required="N" />
    <field name="ExecID" required="N" />
    <field name="ExpireTime" required="N" />
    <field name="MarketIndicator" required="N" />
    <field name="Password" required="N" />
    <field name="QueryPageNumber" required="N" />
    <field name="QueryPageSize" required="N" />
    <field name="SettlDate" required="N" />
    <field name="SettlInstReqID" required="N" />
    <field name="SettlInstReqType" required="N" />
    <field name="SettlObligID" required="N" />
    <field name="SettlObligMode" required="N" />
    <field name="SettlObligTransType" required="N" />
    <field name="Side" required="N" />

```

```

    <field name="SingleDataIndic" required="N" />
    <field name="TradeInstrument" required="N" />
    <field name="TransactTime" required="N" />
    <field name="Username" required="N" />
    <component name="Parties" required="N" />
</message>
<message name="SettlementObligationReport" description="" msgtype="BQ"
msgcat="app">
    <field name="ClearingBusinessDate" required="N" />
    <field name="CNYTradedIndic" required="N" />
    <field name="MarketIndicator" required="N" />
    <field name="MessageID" required="N" />
    <field name="Password" required="N" />
    <field name="PaymentDate" required="N" />
    <field name="ReceivingDate" required="N" />
    <field name="SettlInstReqID" required="N" />
    <field name="SettlObligMode" required="N" />
    <field name="SettlObligMsgID" required="N" />
    <field name="SettlReportStatus" required="N" />
    <field name="SettlReportType" required="N" />
    <field name="SubmitTime" required="N" />
    <field name="Text" required="N" />
    <field name="TradeInstrument" required="N" />
    <field name="TransactTime" required="N" />
    <field name="Username" required="N" />
    <component name="PaginationCtrl" required="N" />
    <component name="SettlObligationInstruction" required="N" />
</message>
<message name="SettlObligationReportAck" description="" msgtype="U31"
msgcat="app">
    <field name="MessageID" required="N" />
    <field name="SettlObligID" required="N" />
    <field name="SettlObligMode" required="N" />
    <field name="SettlObligMsgID" required="N" />
    <field name="SettlReportStatus" required="N" />
    <field name="Text" required="N" />
    <field name="TransactTime" required="N" />
</message>
<message name="SettRepConfirm" description="" msgtype="U41" msgcat="app">
    <field name="SettlExecStatus" required="N" />
    <field name="SettlObligMsgID" required="N" />
    <field name="SettRepCnfID" required="N" />
    <field name="Text" required="N" />

```

```

    <field name="TransactTime" required="N" />
    <component name="SettlExecGrp" required="N" />
</message>
<message name="SettRepConfirmAck" description="" msgtype="U66" msgcat="app">
    <field name="SettRepCnfID" required="N" />
    <field name="TransactTime" required="N" />
</message>
<message name="SettRepConInquiry" description="" msgtype="U58" msgcat="app">
    <field name="ClearingBusinessDate" required="N" />
    <field name="SettRepConInquiryID" required="N" />
    <field name="TransactTime" required="N" />
</message>
<message name="SubscribRequest" description="" msgtype="U27" msgcat="app">
    <field name="QuoteMode" required="N" />
    <field name="SubscriptionRequestID" required="N" />
    <field name="SubscriptionRequestType" required="N" />
    <field name="SubscriptionTransType" required="N" />
    <field name="TransactTime" required="N" />
    <component name="Instrument" required="N" />
    <component name="MDEntryGrp" required="N" />
</message>
<message name="SubscribRequestAck" description="The acknowledgement of
SubscribRequest message to indicate whether it is accepted." msgtype="U76"
msgcat="app">
    <field name="QuoteMode" required="N" />
    <field name="SubscriptionRequestID" required="N" />
    <field name="SubscriptionStatus" required="N" />
    <field name="Text" required="N" />
    <component name="Instrument" required="N" />
</message>
<message name="TadeFeeInfo" description="" msgtype="U19" msgcat="app">
    <field name="DataCategoryIndicator" required="N" />
    <field name="ExecID" required="N" />
    <field name="FeeActualAmt" required="N" />
    <field name="FeePreferentialAmt" required="N" />
    <field name="FeeRate" required="N" />
    <field name="FeesInfoType" required="N" />
    <field name="IncrementalTradeAmt" required="N" />
    <field name="PreferentialSpread" required="N" />
    <field name="PreferentialType" required="N" />
    <field name="QueryRequestID" required="N" />
    <field name="Side" required="N" />
    <field name="TermType" required="N" />

```



```

<field name="TradeDate" required="N" />
<field name="TradeLimitDays" required="N" />
<field name="TradeTime" required="N" />
<field name="TransactTime" required="N" />
<field name="UpdateTime" required="N" />
<field name="UpdateUser" required="N" />
<component name="Instrument" required="N" />
<component name="MiscFeesGrp" required="N" />
<component name="OrderQtyData" required="N" />
<component name="PaginationCtrl" required="N" />
<component name="Parties" required="N" />
<component name="TradeFeeGrp" required="N" />
</message>
<message name="TestRequest" description="" msgtype="1" msgcat="admin">
  <field name="TestReqID" required="N" />
</message>
<message name="TradeCaptureReport" description="" msgtype="AE" msgcat="app">
  <field name="AbnorExecDesc" required="N" />
  <field name="AccruedInterestAmt" required="N" />
  <field name="AccruedInterestTotalAmt" required="N" />
  <field name="CalculatedCcyLastQty" required="N" />
  <field name="CashHoldingDays" required="N" />
  <field name="CNYTradedIndic" required="N" />
  <field name="ContingencyIndicator" required="N" />
  <field name="Currency" required="N" />
  <field name="DateConfirmed" required="N" />
  <field name="DealID" required="N" />
  <field name="DirtyPrice" required="N" />
  <field name="ExecCxlID" required="N" />
  <field name="ExecCxlTime" required="N" />
  <field name="ExecID" required="N" />
  <field name="ExecType" required="N" />
  <field name="FeedBackIndicator" required="N" />
  <field name="LastModifyTime" required="N" />
  <field name="LastPx" required="N" />
  <field name="LastQty" required="N" />
  <field name="LastRptRequested" required="N" />
  <field name="MarginRequired" required="N" />
  <field name="MsgNumofCurrPage" required="N" />
  <field name="Price" required="N" />
  <field name="QueryRequestID" required="N" />
  <field name="QuoteID" required="N" />
  <field name="RiskLastQty" required="N" />

```

```

<field name="SettlCurrAmt" required="N" />
<field name="SettlCurrAmt2" required="N" />
<field name="SettlDate" required="N" />
<field name="SettlDate2" required="N" />
<field name="SettlType" required="N" />
<field name="Side" required="N" />
<field name="Text" required="N" />
<field name="TotNumReports" required="N" />
<field name="TradeDate" required="N" />
<field name="TradeFwdDays" required="N" />
<field name="TradeInstrument" required="N" />
<field name="TradeLimitDays" required="N" />
<field name="TradeMethod" required="N" />
<field name="TradeReportID" required="N" />
<field name="TradeReportTransType" required="N" />
<field name="TradeTime" required="N" />
<field name="TradeType" required="N" />
<field name="TradingSessionID" required="N" />
<field name="TransactTime" required="N" />
<component name="FinancingDetails" required="N" />
<component name="InstrmtLegExecGrp" required="N" />
<component name="Instrument" required="N" />
<component name="MiscFeesGrp" required="N" />
<component name="OrderQtyData" required="N" />
<component name="SpreadOrBenchmarkCurveData" required="N" />
<component name="Stipulations" required="N" />
<component name="TrdCapRptSideGrp" required="N" />
<component name="UndInstrmtGrp" required="N" />
<component name="YieldData" required="N" />
</message>
<message name="TradeCaptureReportAck" description="" msgtype="AR"
msgcat="app">
  <field name="CNYTradedIndic" required="N" />
  <field name="ExecID" required="N" />
  <field name="MarketIndicator" required="N" />
  <field name="Text" required="N" />
  <field name="TradeInstrument" required="N" />
  <field name="TradeReportID" required="N" />
  <field name="TradeReportRejectReason" required="N" />
  <field name="TradingSessionID" required="N" />
  <field name="TransactTime" required="N" />
  <field name="TrdRptStatus" required="N" />
</message>

```

```

<message name="TradeControlReport" description="" msgtype="U03"
msgcat="app">
  <field name="ExecID" required="N" />
  <field name="FeedBackIndicator" required="N" />
  <field name="PreDealFlag" required="N" />
  <field name="Side" required="N" />
  <field name="Text" required="N" />
  <field name="TradeReportRejectReason" required="N" />
  <field name="TradingSessionID" required="N" />
  <field name="TransactTime" required="N" />
  <field name="TrdContrRepID" required="N" />
  <component name="Instrument" required="N" />
  <component name="OrderQtyData" required="N" />
  <component name="Parties" required="N" />
</message>
<message name="TradingSessionStatus" description="" msgtype="h"
msgcat="app">
  <field name="CNYTradedIndic" required="N" />
  <field name="TotalDealCount" required="N" />
  <field name="TradeInstrument" required="N" />
  <field name="TradeMethod" required="N" />
  <field name="TradingSessionID" required="N" />
  <field name="TradSesCloseTime" required="N" />
  <field name="TradSesEndTime" required="N" />
  <field name="TradSesOpenTime" required="N" />
  <field name="TradSesPreCloseTime" required="N" />
  <field name="TradSesReqID" required="N" />
  <field name="TradSesStartTime" required="N" />
  <field name="TradSesStatus" required="N" />
  <field name="TransactTime" required="N" />
  <component name="Instrument" required="N" />
</message>
<message name="TradingSessionStatusAck" description="" msgtype="U73"
msgcat="app">
  <field name="TradingSessionID" required="N" />
  <field name="TransactTime" required="N" />
</message>
<message name="TradingSessionStatusRequest" description="" msgtype="g"
msgcat="app">
  <field name="CNYTradedIndic" required="N" />
  <field name="MarketIndicator" required="N" />
  <field name="TradeInstrument" required="N" />
  <field name="TradSesReqID" required="N" />

```

```

    <field name="TransactTime" required="N" />
</message>
<message name="UserRequest" description="" msgtype="BE" msgcat="app">
    <field name="NewPassword" required="N" />
    <field name="Password" required="N" />
    <field name="RawData" required="N" />
    <field name="RawDataLength" required="N" />
    <field name="TransactTime" required="N" />
    <field name="Username" required="N" />
    <field name="UserRequestID" required="N" />
    <field name="UserRequestType" required="N" />
</message>
<message name="UserResponse" description="" msgtype="BF" msgcat="app">
    <field name="TransactTime" required="N" />
    <field name="Username" required="N" />
    <field name="UserRequestID" required="N" />
    <field name="UserStatus" required="N" />
    <field name="UserStatusText" required="N" />
</message>
</messages>
<components>
    <component name="AccountInfoGrp" description="">
        <group name="NoAccountInfo" required="N">
            <field name="AccountInfoID" required="Y" />
            <field name="AccountInfoIDType" required="N" />
            <field name="Currency" required="N" />
        </group>
    </component>
    <component name="AttrbGrp" description="">
        <group name="NoInstrAttrib" required="N">
            <field name="InstrAttribType" required="Y" />
            <field name="InstrAttribValue" required="N" />
        </group>
    </component>
    <component name="BenchmarkGrp" description="">
        <group name="NoBenchmarks" required="N">
            <component name="SpreadOrBenchmarkCurveData" required="Y" />
        </group>
    </component>
    <component name="BulletinGrp" description="">
        <group name="NoBulletins" required="N">
            <field name="BulletinID" required="Y" />
            <field name="BulletinCaption" required="N" />
        </group>
    </component>

```

```

    <field name="EndDate" required="N" />
    <field name="FeedBackIndicator" required="N" />
    <field name="IssueDate" required="N" />
    <field name="StartDate" required="N" />
    <field name="Text" required="N" />
    <component name="Parties" required="N" />
  </group>
</component>
<component name="BusinessParamGrp" description="">
  <group name="NoBusinessParams" required="N">
    <field name="MarketIndicator" required="Y" />
    <component name="BusinessParamSubGrp" required="N" />
  </group>
</component>
<component name="BusinessParamSubGrp" description="">
  <group name="NoSubParams" required="N">
    <field name="BusinessParamType" required="Y" />
    <field name="BusinessParamValue" required="N" />
  </group>
</component>
<component name="CollApplGrp" description="">
  <group name="NoCollAppl" required="N">
    <field name="CollApplType" required="Y" />
  </group>
</component>
<component name="ComplexEventDates" description="">
  <group name="NoComplexEventDates" required="N">
    <field name="ComplexEventDateType" required="Y" />
    <field name="ComplexEventEndDate" required="N" />
    <field name="ComplexEventStartDate" required="N" />
  </group>
</component>
<component name="ComplexEvents" description="">
  <group name="NoComplexEvents" required="N">
    <field name="ComplexEventType" required="Y" />
    <field name="ComplexEventPrice" required="N" />
    <field name="ComplexEventPriceBoundaryMethod" required="N" />
    <field name="ComplexEventSequence" required="N" />
    <field name="ComplexEventUnstrikeCouponRate" required="N" />
    <field name="ComplexEventUnstrikeSpread" required="N" />
    <field name="TriggerDesc" required="N" />
    <field name="TriggerIndicator" required="N" />
    <component name="ComplexEventDates" required="N" />
  </group>
</component>

```

```

    </group>
</component>
<component name="ContactInfoGrp" description="">
  <group name="NoContactInfos" required="N">
    <field name="ContactInfoID" required="Y" />
    <field name="ContactInfoIDType" required="N" />
  </group>
</component>
<component name="ContAmtGrp" description="">
  <group name="NoContAmts" required="N">
    <field name="ContAmtValue" required="Y" />
    <field name="ContAmtType" required="N" />
  </group>
</component>
<component name="ConvertInfoGrp" description="">
  <group name="NoConvertInfo" required="N">
    <field name="ConvertType" required="Y" />
    <field name="ConvertDate" required="N" />
    <field name="ConvertOfFaceValue" required="N" />
    <field name="ConvertPx" required="N" />
  </group>
</component>
<component name="ConvertIntoGrp" description="">
  <group name="NoConverts" required="N">
    <field name="CnvtIntoAmt" required="Y" />
    <field name="CnvtIntoCurrency" required="N" />
    <field name="CurrentFXRate" required="N" />
  </group>
</component>
<component name="CredtrRateAgencyInfoGrp" description="">
  <group name="NoCredtrRateAgencyInfo" required="N">
    <field name="CreditRatingAgency" required="Y" />
    <field name="CreditRating" required="N" />
    <field name="CreditRatingType" required="N" />
    <field name="CreditValidityFrom" required="N" />
    <field name="CreditValidityTo" required="N" />
    <field name="RatedExpect" required="N" />
    <field name="RatedObjectID" required="N" />
    <field name="RatedObjectName" required="N" />
  </group>
</component>
<component name="CurvePxGrp" description="">
  <group name="NoCurves" required="N">

```

```

    <field name="CurveType" required="Y" />
    <field name="Spread" required="N" />
    <field name="YieldPx" required="N" />
  </group>
</component>
<component name="DBCharacterSetsGrp" description="">
  <group name="NoDBCharacterSets" required="N">
    <field name="DBCharacterSetName" required="Y" />
    <field name="DBCharacterSetValue" required="N" />
  </group>
</component>
<component name="DBNameGrp" description="">
  <group name="NoDBNames" required="N">
    <field name="DataBaseName" required="Y" />
  </group>
</component>
<component name="DBSchemaGrp" description="">
  <group name="NoDBSchemas" required="N">
    <field name="DBSchemaName" required="Y" />
  </group>
</component>
<component name="DBTableColGrp" description="">
  <group name="NoDBTableColumns" required="N">
    <field name="DBTableColName" required="Y" />
    <field name="DBTableColComments" required="N" />
    <field name="DBTableColDefault" required="N" />
    <field name="DBTableColNull" required="N" />
    <field name="DBTableColPKKey" required="N" />
    <field name="DBTableColType" required="N" />
  </group>
</component>
<component name="DBTableGrp" description="">
  <group name="NoDBTables" required="N">
    <field name="DBTableName" required="Y" />
    <field name="DBTableComments" required="N" />
  </group>
</component>
<component name="DBViewGrp" description="">
  <group name="NoDBViews" required="N">
    <field name="DBViewName" required="Y" />
    <field name="DBViewComments" required="N" />
  </group>
</component>

```

```

<component name="DeliveryOptionGrp" description="">
  <group name="NoDeliveryTypeOption" required="N">
    <field name="DeliveryOptionDirection" required="Y" />
    <field name="DeliveryTypeOption" required="N" />
  </group>
</component>
<component name="DisplayInstruction" description="">
  <field name="DisplayQty" required="N" />
</component>
<component name="DownloadedDataGrp" description="">
  <group name="NoDownloadedData" required="N">
    <field name="DownloadedDataType" required="Y" />
    <field name="DownloadedDataValue" required="N" />
  </group>
</component>
<component name="DownloadParamGrp" description="">
  <group name="NoDownloadParam" required="N">
    <field name="DownloadParamType" required="Y" />
    <field name="DownloadParamValue" required="N" />
  </group>
</component>
<component name="EligibilityIndicators" description="">
  <field name="CashBondIndicator" required="Y" />
  <field name="BondForwardIndicator" required="N" />
  <field name="CollateralRepoEligibilityIndicator" required="N" />
  <field name="OptionEligibilityIndicator" required="N" />
  <field name="OutrightRepoEligibilityIndicator" required="N" />
  <field name="SBLIndicator" required="N" />
  <field name="WhenIssuedIndicator" required="N" />
</component>
<component name="EvntGrp" description="">
  <group name="NoEvents" required="N">
    <field name="EventType" required="Y" />
    <field name="EventDate" required="N" />
    <field name="EventPx" required="N" />
    <field name="EventText" required="N" />
    <component name="Stipulations" required="N" />
  </group>
</component>
<component name="ExecCollGrp" description="">
  <group name="NoExecs" required="N">
    <field name="ExecID" required="Y" />
    <field name="LastMarginSubmitDate" required="N" />
  </group>
</component>

```



```

    <field name="LastModifyTime" required="N" />
    <field name="MarginAMTRequired" required="N" />
    <field name="MarginSubmitAmt" required="N" />
    <field name="ProcessingStatus" required="N" />
    <field name="TradeDate" required="N" />
    <field name="TradeTime" required="N" />
    <field name="UpdatOperation" required="N" />
    <component name="Parties" required="N" />
  </group>
</component>
<component name="FinancingDetails" description="">
  <field name="DeliveryType" required="N" />
  <field name="DeliveryType2" required="N" />
  <field name="EndDate" required="N" />
  <field name="StartDate" required="N" />
</component>
<component name="FundValueGrp" description="">
  <group name="NoFundValues" required="N">
    <field name="NetTotalIndicator" required="Y" />
    <field name="EffectiveTime" required="N" />
    <field name="FundValue" required="N" />
    <field name="ProcessingStatus" required="N" />
  </group>
</component>
<component name="GroupGrp" description="">
  <group name="NoGroupsIDs" required="N">
    <field name="GroupID" required="Y" />
    <field name="GroupRole" required="N" />
    <component name="Parties" required="N" />
  </group>
</component>
<component name="HistoryInfoGrp" description="">
  <group name="NoHistoryInfo" required="N">
    <field name="CreditValidityFrom" required="Y" />
    <field name="AmendmentDate" required="N" />
    <field name="CirculationSize" required="N" />
    <field name="CreditRating" required="N" />
    <field name="CreditRatingAgency" required="N" />
    <field name="CreditValidityTo" required="N" />
    <field name="Issuer" required="N" />
    <field name="Principal" required="N" />
  </group>
</component>

```

```

<component name="HopsGroup" description="">
  <group name="NoHops" required="N">
    <field name="HopCompID" required="Y" />
    <field name="HopRefID" required="N" />
    <field name="HopSendingTime" required="N" />
  </group>
</component>
<component name="InheritInfo" description="">
  <group name="NoInheritInfo" required="N">
    <field name="InheritInstitutionName" required="Y" />
    <field name="InheritDate" required="N" />
    <field name="InheritDesc" required="N" />
  </group>
</component>
<component name="InitialExGrp" description="">
  <group name="NoInitialExchange" required="N">
    <field name="IniExReqIndicator" required="Y" />
    <field name="IniExAmount" required="N" />
    <field name="IniExDate" required="N" />
    <field name="IniExDirIndicator" required="N" />
  </group>
</component>
<component name="InstrmtLegExecGrp" description="">
  <group name="NoLegs" required="N">
    <component name="InstrumentLeg" required="Y" />
    <field name="LegCalculatedCcyLastQty" required="N" />
    <field name="LegInterestAccuralDaysAdjustment" required="N" />
    <field name="LegLastForwardPoints" required="N" />
    <field name="LegLastPx" required="N" />
    <field name="LegLastSpotRate" required="N" />
    <field name="LegOrderQty" required="N" />
    <field name="LegPrice" required="N" />
    <field name="LegPriceType" required="N" />
    <field name="LegRiskOrderQty" required="N" />
    <field name="LegSettlCurrency" required="N" />
    <field name="LegSettlDate" required="N" />
    <field name="LegSettlType" required="N" />
    <field name="LegSpotDate" required="N" />
    <component name="LegBenchmarkCurveData" required="N" />
    <component name="LegStipulations" required="N" />
  </group>
</component>
<component name="InstrmtLegIOIGrp" description="">

```

```

<group name="NoLegs" required="N">
  <component name="InstrumentLeg" required="Y" />
  <field name="LegInterestAccrualDaysAdjustment" required="N" />
  <field name="LegIOIQty" required="N" />
  <field name="LegPrice" required="N" />
  <field name="LegPriceType" required="N" />
  <field name="LegSettlDate" required="N" />
  <field name="LegSettlType" required="N" />
  <field name="LegSign" required="N" />
  <component name="LegBenchmarkCurveData" required="N" />
  <component name="LegStipulations" required="N" />
</group>
</component>
<component name="Instrument" description="">
  <field name="SecurityID" required="Y" />
  <field name="ActualMaturityDate" required="N" />
  <field name="AnnouncementDate" required="N" />
  <field name="CalcMethod" required="N" />
  <field name="CashSubPropCap" required="N" />
  <field name="CirculationSize" required="N" />
  <field name="ContractSettlMonth" required="N" />
  <field name="CorrespStrdSecurityTerm" required="N" />
  <field name="CountryOfIssue" required="N" />
  <field name="CouponPaymentDate" required="N" />
  <field name="CouponPaymentFrequency" required="N" />
  <field name="CouponRate" required="N" />
  <field name="CouponRateType" required="N" />
  <field name="CpnPmtFreqDesc" required="N" />
  <field name="CreditRating" required="N" />
  <field name="CreditRatingAgency" required="N" />
  <field name="DatedDate" required="N" />
  <field name="DelistDate" required="N" />
  <field name="EstablishDate" required="N" />
  <field name="FaceValue" required="N" />
  <field name="FirstPeriodStartDate" required="N" />
  <field name="FullSymbol" required="N" />
  <field name="IndexOfPresentTotalValue" required="N" />
  <field name="InterestAccrualDate" required="N" />
  <field name="InterestAccrualResetFrequency" required="N" />
  <field name="InterestCurrency" required="N" />
  <field name="IOPValue" required="N" />
  <field name="IssueDate" required="N" />
  <field name="IssueMethod" required="N" />

```

```
<field name="IssuePx" required="N" />
<field name="Issuer" required="N" />
<field name="IssuerAltName" required="N" />
<field name="IssuerCountry" required="N" />
<field name="IssuerProperty" required="N" />
<field name="IssueSize" required="N" />
<field name="IssueSizeForPlan" required="N" />
<field name="LastIOPValue" required="N" />
<field name="LastSubRedempMinUnit" required="N" />
<field name="LastTradeDate" required="N" />
<field name="ListDate" required="N" />
<field name="ListedIndicator" required="N" />
<field name="MarketID" required="N" />
<field name="MarketIndicator" required="N" />
<field name="MaturityDate" required="N" />
<field name="MaxSingleDayLimit" required="N" />
<field name="MaxSingleDayLimitReminder" required="N" />
<field name="MinSingleDayLimit" required="N" />
<field name="MinSingleDayLimitReminder" required="N" />
<field name="NextCouponPaymentDate" required="N" />
<field name="NextSingleDayBuyLimit" required="N" />
<field name="NextSingleDaySellLimit" required="N" />
<field name="OfferMethod" required="N" />
<field name="Principal" required="N" />
<field name="PrincipalPaymentRate" required="N" />
<field name="PutOrCall" required="N" />
<field name="RedemptionDate" required="N" />
<field name="RedemptionFrequency" required="N" />
<field name="RegisteredCapital" required="N" />
<field name="SecSettleLocation" required="N" />
<field name="SecurityAttribute" required="N" />
<field name="SecurityIDSsource" required="N" />
<field name="SecurityISINID" required="N" />
<field name="SecurityTerm" required="N" />
<field name="SecurityTermString" required="N" />
<field name="SecurityType" required="N" />
<field name="SingleDayUtilizeLimit" required="N" />
<field name="SplitIndicator" required="N" />
<field name="StrikePrice" required="N" />
<field name="SubRedempIndicator" required="N" />
<field name="SubRedempMinUnit" required="N" />
<field name="Symbol" required="N" />
<field name="TermToMaturity" required="N" />
```

```

<field name="TotalPrincipal" required="N" />
<field name="TradeEstimatedCashAmt" required="N" />
<field name="UnderWriteMethod" required="N" />
<field name="WithdrawIndic" required="N" />
</component>
<component name="InstrumentExtension" description="">
  <field name="DeliveryForm" required="N" />
  <component name="AttrbGrp" required="N" />
</component>
<component name="InstrumentLeg" description="">
  <field name="LegSide" required="Y" />
  <field name="LegAccruedInterestAmt" required="N" />
  <field name="LegAccruedInterestTotalAmt" required="N" />
  <field name="LegBenchmarkTenor" required="N" />
  <field name="LegCouponPaymentDate" required="N" />
  <field name="LegCouponPaymentDateReset" required="N" />
  <field name="LegCouponPaymentFrequency" required="N" />
  <field name="LegCouponRate" required="N" />
  <field name="LegCurrency" required="N" />
  <field name="LegDayCount" required="N" />
  <field name="LegDeliveryType" required="N" />
  <field name="LegDeliveryType2" required="N" />
  <field name="LegDirtyPrice" required="N" />
  <field name="LegFixingDateIndicator" required="N" />
  <field name="LegInterestAccrualDate" required="N" />
  <field name="LegInterestAccrualMethod" required="N" />
  <field name="LegInterestAccrualResetDateAdjust" required="N" />
  <field name="LegInterestAccrualResetFrequency" required="N" />
  <field name="LegInterestFixDateAdjustment" required="N" />
  <field name="LegIssueDate" required="N" />
  <field name="LegIssuer" required="N" />
  <field name="LegLastQty" required="N" />
  <field name="LegMaturityDate" required="N" />
  <field name="LegMaturityMonthYear" required="N" />
  <field name="LegMaxFloor" required="N" />
  <field name="LegMaxQty" required="N" />
  <field name="LegMinQty" required="N" />
  <field name="LegMinTickSize" required="N" />
  <field name="LegPrincipal" required="N" />
  <field name="LegSecurityID" required="N" />
  <field name="LegSecurityIDSource" required="N" />
  <field name="LegSettlCurrAmt" required="N" />
  <field name="LegSettlCurrAmt2" required="N" />

```

```

    <field name="LegSolveForIndicator" required="N" />
    <field name="LegSymbol" required="N" />
    <field name="LegTotalPrincipal" required="N" />
    <field name="LegTradeCashAmt" required="N" />
    <field name="LegValidUntilTime" required="N" />
</component>
<component name="IssuerGrp" description="">
    <group name="NoIssuer" required="N">
        <field name="Issuer" required="Y" />
        <field name="EstablishDate" required="N" />
        <field name="Industry" required="N" />
        <field name="IssuerLimit" required="N" />
        <field name="IssuerProperty" required="N" />
        <field name="ListedIndicator" required="N" />
        <field name="RegisteredCapital" required="N" />
        <component name="Parties" required="N" />
    </group>
</component>
<component name="LegBenchmarkCurveData" description="">
    <field name="LegBenchmarkCurveCurrency" required="N" />
    <field name="LegBenchmarkCurveName" required="N" />
    <field name="LegBenchmarkCurvePoint" required="N" />
    <field name="LegBenchmarkPrice" required="N" />
    <field name="LegBenchmarkPriceType" required="N" />
    <field name="LegBenchmarkSpread" required="N" />
</component>
<component name="LegOrdGrp" description="">
    <group name="NoLegs" required="N">
        <component name="InstrumentLeg" required="Y" />
        <field name="LegBidForwardPoints" required="N" />
        <field name="LegBidPx" required="N" />
        <field name="LegCalculatedCcyLastQty" required="N" />
        <field name="LegForwardPoints" required="N" />
        <field name="LegOfferForwardPoints" required="N" />
        <field name="LegOfferPx" required="N" />
        <field name="LegOrderQty" required="N" />
        <field name="LegPrice" required="N" />
        <field name="LegRiskOrderQty" required="N" />
        <field name="LegSettlDate" required="N" />
        <field name="LegSettlType" required="N" />
        <field name="LegSpotDate" required="N" />
        <field name="LegTtlClmtveAmt" required="N" />
        <component name="LegOrdInfoGrp" required="N" />
    </group>
</component>

```

```

    </group>
</component>
<component name="LegOrdInfoGrp" description="">
  <group name="NoLegOrders" required="N">
    <field name="LegPrice" required="Y" />
    <field name="AnonymousIndicator" required="N" />
    <field name="LegAccruedInterestAmt" required="N" />
    <field name="LegAccruedInterestTotalAmt" required="N" />
    <field name="LegClmtveAmt" required="N" />
    <field name="LegDirtyPrice" required="N" />
    <field name="LegOrderCount" required="N" />
    <field name="LegOrderQty" required="N" />
    <field name="LegOrdSeqNo" required="N" />
    <field name="LegQuoteID" required="N" />
    <field name="LegQuotetime" required="N" />
    <field name="LegSettlCurrAmt" required="N" />
    <field name="LegSettlType" required="N" />
    <field name="LegTradeCashAmt" required="N" />
    <component name="LegParties" required="N" />
    <component name="LegStipulations" required="N" />
  </group>
</component>
<component name="LegParties" description="">
  <group name="NoLegPartyIDs" required="N">
    <field name="LegPartyID" required="Y" />
    <field name="LegPartyRole" required="N" />
    <component name="LegPtysSubGrp" required="N" />
  </group>
</component>
<component name="LegPtysSubGrp" description="">
  <group name="NoLegPartySubIDs" required="N">
    <field name="LegPartySubID" required="Y" />
    <field name="LegPartySubIDType" required="N" />
  </group>
</component>
<component name="LegQuotGrp" description="">
  <group name="NoLegs" required="N">
    <component name="InstrumentLeg" required="Y" />
    <field name="LegBidForwardPoints" required="N" />
    <field name="LegBidPx" required="N" />
    <field name="LegCalculatedCcyLastQty" required="N" />
    <field name="LegDisplayQty" required="N" />
    <field name="LegInterestAccrualDaysAdjustment" required="N" />
  </group>
</component>

```

```

    <field name="LegLeaveQty" required="N" />
    <field name="LegNetGrossInd" required="N" />
    <field name="LegOfferForwardPoints" required="N" />
    <field name="LegOfferPx" required="N" />
    <field name="LegOrderQty" required="N" />
    <field name="LegPrice" required="N" />
    <field name="LegPriceType" required="N" />
    <field name="LegRiskOrderQty" required="N" />
    <field name="LegSettlDate" required="N" />
    <field name="LegSettlType" required="N" />
    <field name="LegSpotDate" required="N" />
    <component name="LegBenchmarkCurveData" required="N" />
    <component name="LegStipulations" required="N" />
  </group>
</component>
<component name="LegStipulations" description="">
  <group name="NoLegStipulations" required="N">
    <field name="LegStipulationType" required="Y" />
    <field name="LegStipulationValue" required="N" />
  </group>
</component>
<component name="LimitDataGrp" description="">
  <group name="NoLimits" required="N">
    <field name="LimitValue" required="Y" />
    <field name="LimitSubType" required="N" />
  </group>
</component>
<component name="LimitInfoGrp" description="">
  <group name="NoLimitInfo" required="N">
    <field name="LimitInfoType" required="Y" />
    <field name="Currency" required="N" />
    <field name="LimitCategory" required="N" />
    <field name="ValidUntilDate" required="N" />
    <component name="Instrument" required="N" />
    <component name="LimitInfoSubGrp" required="N" />
    <component name="Parties" required="N" />
  </group>
</component>
<component name="LimitInfoSubGrp" description="">
  <group name="NoLimitSubInfo" required="N">
    <field name="GrossOrNet" required="Y" />
    <component name="LimitDataGrp" required="N" />
  </group>

```



```

</component>
<component name="LiquidProviderGrp" description="">
  <group name="NoLiquidProvider" required="N">
    <field name="LiquidProviderType" required="Y" />
    <field name="LiquidProvider" required="N" />
  </group>
</component>
<component name="MarginAccountInfo" description="">
  <field name="MarginAccountAmt" required="Y" />
  <field name="AvailableAmt" required="N" />
  <field name="ChangedAmt" required="N" />
  <field name="CollateralType" required="N" />
  <field name="FrozenAmt" required="N" />
  <field name="LeastLimitReqedAmt" required="N" />
  <field name="PendingAmt" required="N" />
</component>
<component name="MarginAMTGrp" description="">
  <group name="NoMarginAmt" required="N">
    <field name="MarginAMT" required="Y" />
    <field name="AvailableAmt" required="N" />
    <field name="MarginAgency" required="N" />
    <field name="MarginCreditTtlAmt" required="N" />
    <field name="MarginCurrency" required="N" />
    <field name="MarginDebitTtlAmt" required="N" />
    <field name="MarginMinTickSize" required="N" />
    <field name="MarginRate" required="N" />
    <field name="MarginTraced" required="N" />
    <field name="PaymentRoute" required="N" />
    <field name="RelatedReference" required="N" />
    <field name="SettlDate" required="N" />
    <component name="ConvertIntoGrp" required="N" />
    <component name="MarginExecDetailsGrp" required="N" />
  </group>
</component>
<component name="MarginARDtlGrp" description="">
  <group name="NoMarginARs" required="N">
    <field name="MarginType" required="Y" />
    <field name="MarginAMT" required="N" />
    <field name="MarginCurrency" required="N" />
    <field name="MarginIndicator" required="N" />
    <field name="MarginSecuritiesID" required="N" />
    <field name="MarginSymbol" required="N" />
    <field name="PaymentRoute" required="N" />
  </group>

```

```

    <field name="SettlDate" required="N" />
    <component name="ConvertIntoGrp" required="N" />
  </group>
</component>
<component name="MarginBaseInfoGrp" description="">
  <group name="NoMarginBaseInfo" required="N">
    <field name="MarginType" required="Y" />
    <field name="MarginCurrency" required="N" />
    <field name="MarginFaceValue" required="N" />
    <field name="MarginIndicator" required="N" />
    <field name="MarginMinTickSize" required="N" />
    <field name="MarginRate" required="N" />
    <field name="MarginSecuritiesID" required="N" />
    <field name="MarginSymbol" required="N" />
  </group>
</component>
<component name="MarginCashInstGrp" description="">
  <group name="NoCashInsts" required="N">
    <field name="MarginCurrency" required="Y" />
    <field name="MarginInstAmt" required="N" />
  </group>
</component>
<component name="MarginDPDtlGrp" description="">
  <group name="NoMarginDPS" required="N">
    <field name="MarginType" required="Y" />
    <field name="DrawRespStatus" required="N" />
    <field name="MarginAMT" required="N" />
    <field name="MarginCurrency" required="N" />
    <field name="MarginIndicator" required="N" />
    <field name="MarginSecuritiesID" required="N" />
    <field name="MarginSymbol" required="N" />
    <field name="RelatedReference" required="N" />
    <field name="SettlDate" required="N" />
    <field name="SWIFTType" required="N" />
    <field name="TradeDate" required="N" />
    <field name="TransferDirection" required="N" />
    <component name="Parties" required="N" />
  </group>
</component>
<component name="MarginExecDetailsGrp" description="">
  <group name="NoMarginExecs" required="N">
    <field name="ExecID" required="Y" />
    <field name="MarginCreditAmt" required="N" />
  </group>

```

```

    <field name="MarginDebitAmt" required="N" />
    <field name="Text" required="N" />
  </group>
</component>
<component name="MarginInfoGrp" description="">
  <group name="NoMarginInfo" required="N">
    <field name="MarginType" required="Y" />
    <field name="CnvtIntoCurrency" required="N" />
    <field name="CollRatio" required="N" />
    <field name="MarginDirection" required="N" />
    <field name="MarginIndicator" required="N" />
    <field name="MarginPartyRole" required="N" />
    <field name="MarginReplacement" required="N" />
    <field name="MarginSubmitDate" required="N" />
    <field name="MarginTotalAmt" required="N" />
    <field name="SettlLimitAmt" required="N" />
    <component name="CollApplGrp" required="N" />
    <component name="MarginAccountInfo" required="N" />
    <component name="MarginAMTGrp" required="N" />
    <component name="MarginCashInstGrp" required="N" />
    <component name="MarginParties" required="N" />
    <component name="MarginSecuritiesGrp" required="N" />
    <component name="MarginSecuritiesInstGrp" required="N" />
  </group>
</component>
<component name="MarginParties" description="">
  <group name="NoMarginPartyIDs" required="N">
    <field name="MarginPartyID" required="Y" />
    <component name="MarginPtysSubGrp" required="N" />
  </group>
</component>
<component name="MarginPtysSubGrp" description="">
  <group name="NoMarginPartySubIDs" required="N">
    <field name="MarginPartySubID" required="Y" />
    <field name="MarginPartySubIDType" required="N" />
  </group>
</component>
<component name="MarginSecuritiesGrp" description="">
  <group name="NoMarginSecurities" required="N">
    <field name="MarginSecuritiesID" required="Y" />
    <field name="ForeNoticeIndic" required="N" />
    <field name="MarginAgency" required="N" />
    <field name="MarginAMT" required="N" />
  </group>
</component>

```

```

    <field name="MarginCurrency" required="N" />
    <field name="MarginFaceValue" required="N" />
    <field name="MarginInstAmt" required="N" />
    <field name="MarginMktValue" required="N" />
    <field name="MarginRate" required="N" />
    <field name="MarginSecurityIDSource" required="N" />
    <field name="MarginSymbol" required="N" />
    <field name="MarginTraced" required="N" />
    <field name="MaturityDate" required="N" />
    <field name="SettlDate" required="N" />
    <component name="ConvertIntoGrp" required="N" />
    <component name="MarginExecDetailsGrp" required="N" />
  </group>
</component>
<component name="MarginSecuritiesInstGrp" description="">
  <group name="NoSecuritiesInsts" required="N">
    <field name="MarginSecuritiesID" required="Y" />
    <field name="ForeNoticeIndic" required="N" />
    <field name="MarginCurrency" required="N" />
    <field name="MarginInstAmt" required="N" />
    <field name="MarginSymbol" required="N" />
    <component name="Parties" required="N" />
  </group>
</component>
<component name="MarketGrp" description="">
  <group name="NoMarketRange" required="N">
    <field name="MarketRangeType" required="Y" />
    <field name="MarketID" required="N" />
  </group>
</component>
<component name="MDBondIndexGrp" description="">
  <group name="NoIndexes" required="N">
    <field name="IndexType" required="Y" />
    <field name="IndexValue" required="N" />
  </group>
</component>
<component name="MDEntryGrp" description="">
  <group name="NoMDEntryTypes" required="N">
    <field name="MDEntryType" required="Y" />
    <field name="MDEntrySide" required="N" />
  </group>
</component>
<component name="MDFullGrp" description="">

```

```

<group name="NoMDEntries" required="N">
  <field name="MDEntryType" required="Y" />
  <field name="MDEntryDate" required="N" />
  <field name="MDEntryPx" required="N" />
  <field name="MDEntrySide" required="N" />
  <field name="MDEntrySize" required="N" />
  <field name="MDEntryTime" required="N" />
  <field name="SettlDate" required="N" />
  <field name="SettlType" required="N" />
  <field name="Text" required="N" />
  <field name="TradeVolumeFlag" required="N" />
  <field name="ValidUntilTime" required="N" />
  <component name="YieldData" required="N" />
</group>
</component>
<component name="MDInstrumentGrp" description="">
  <group name="NoRelatedSym" required="N">
    <component name="Instrument" required="Y" />
    <field name="BenchmarkPublishFlag" required="N" />
    <field name="BenchmarkState" required="N" />
    <field name="BusinessDtldataID" required="N" />
    <field name="CaculateSign" required="N" />
    <field name="ClearingBusinessDate" required="N" />
    <field name="NetBasisChangePrevDay" required="N" />
    <field name="NetChgPerPrevDay" required="N" />
    <field name="RepeatingCaculateIndicator" required="N" />
    <field name="SettlDate" required="N" />
    <field name="TermFloorLimit" required="N" />
    <field name="TermUpperLimit" required="N" />
    <field name="Text" required="N" />
    <component name="MDFullGrp" required="N" />
    <component name="Parties" required="N" />
    <component name="Stipulations" required="N" />
    <component name="YieldCurveGrp" required="N" />
  </group>
</component>
<component name="MDInstrumentLegGrp" description="">
  <group name="NoLegs" required="N">
    <field name="LegSign" required="Y" />
    <field name="CouponRateType" required="N" />
    <field name="LegCalculatedCcyLastQty" required="N" />
    <field name="LegCouponPaymentFrequency" required="N" />
    <field name="LegCurrency" required="N" />
  </group>
</component>

```

```

<field name="LegDataSource" required="N" />
<field name="LegDayCount" required="N" />
<field name="LegLastForwardPoints" required="N" />
<field name="LegLastPx" required="N" />
<field name="LegLastSpotRate" required="N" />
<field name="LegNetBasisChangePrevDay" required="N" />
<field name="LegNetChgPerPrevDay" required="N" />
<field name="LegOrderQty" required="N" />
<field name="LegPriceType" required="N" />
<field name="LegQuotetime" required="N" />
<field name="LegRiskOrderQty" required="N" />
<field name="LegSecurityID" required="N" />
<field name="LegSecurityIDSource" required="N" />
<field name="LegSecurityType" required="N" />
<field name="LegSettlDate" required="N" />
<field name="LegSettlType" required="N" />
<field name="LegSide" required="N" />
<field name="LegSymbol" required="N" />
<field name="TermToMaturity" required="N" />
<field name="Text" required="N" />
<component name="MDFullGrp" required="N" />
<component name="Parties" required="N" />
</group>
</component>
<component name="MDReqGrp" description="">
  <group name="NoMDEntryTypes" required="N">
    <field name="MDEntryType" required="N" />
  </group>
</component>
<component name="MDTypeGrp" description="">
  <group name="NoMDTypes" required="N">
    <field name="MDType" required="Y" />
    <field name="Currency" required="N" />
    <field name="DerivativeOptAttribute" required="N" />
    <field name="IOPValue" required="N" />
    <field name="KCurveType" required="N" />
    <field name="LastModifyTime" required="N" />
    <field name="MarketIndicator" required="N" />
    <field name="MDSubType" required="N" />
    <field name="MDTypeDescription" required="N" />
    <field name="NetBasisChangePrevDay" required="N" />
    <field name="NetChgPerPrevDay" required="N" />
    <field name="OrderQty" required="N" />
  </group>
</component>

```

```

<field name="SecurityType" required="N" />
<field name="ShiborAveType" required="N" />
<field name="TradeCashAmt" required="N" />
<field name="TradeDate" required="N" />
<field name="TradeFwdDays" required="N" />
<field name="TradeInstrument" required="N" />
<field name="TradeLimitDays" required="N" />
<field name="TradeMethod" required="N" />
<field name="TradingSessionID" required="N" />
<field name="TradSesCloseTime" required="N" />
<field name="TradSesOpenTime" required="N" />
<component name="BenchmarkGrp" required="N" />
<component name="MDInstrumentGrp" required="N" />
<component name="MDInstrumentLegGrp" required="N" />
<component name="UndInstrmtGrp" required="N" />
</group>
</component>
<component name="MiscFeesGrp" description="">
  <group name="NoMiscFees" required="N">
    <field name="MiscFeeAmt" required="Y" />
    <field name="DecimalPlaces" required="N" />
    <field name="FeeMethod" required="N" />
    <field name="FeeRate" required="N" />
    <field name="MiscFeeBasis" required="N" />
    <field name="MiscFeeCurr" required="N" />
    <field name="MiscFeeDate" required="N" />
    <field name="MiscFeeType" required="N" />
  </group>
</component>
<component name="MMInfoGrp" description="">
  <group name="NoMMLegs" required="N">
    <field name="LegSide" required="Y" />
    <field name="LegAccruedInterestAmt" required="N" />
    <field name="LegAccruedInterestTotalAmt" required="N" />
    <field name="LegDirtyPrice" required="N" />
    <field name="LegOrderQty" required="N" />
    <field name="LegPrice" required="N" />
    <field name="LegSettlCurrAmt" required="N" />
    <field name="LegSettlType" required="N" />
    <field name="LegTradeCashAmt" required="N" />
    <component name="LegStipulations" required="N" />
  </group>
</component>

```

```

<component name="MMSetGrp" description="">
  <group name="NoMMsets" required="N">
    <field name="QuoteID" required="Y" />
    <field name="AnonymousIndicator" required="N" />
    <field name="QuoteSetID" required="N" />
    <field name="QuoteTime" required="N" />
    <component name="MMInfoGrp" required="N" />
    <component name="Parties" required="N" />
  </group>
</component>
<component name="OrderQtyData" description="">
  <field name="CashOrderQty" required="N" />
  <field name="OrderQty" required="N" />
</component>
<component name="PaginationCtrl" description="">
  <field name="CurrentNumReports" required="N" />
  <field name="CurrNumOfTot" required="N" />
  <field name="LastFragment" required="N" />
  <field name="LastRptCurrPage" required="N" />
  <field name="LastRptRequested" required="N" />
  <field name="MsgNumofCurrPage" required="N" />
  <field name="QueryPageNumber" required="N" />
  <field name="QueryPageSize" required="N" />
  <field name="TotNumReportPages" required="N" />
  <field name="TotNumReports" required="N" />
</component>
<component name="Parties" description="">
  <group name="NoPartyIDs" required="N">
    <field name="PartyID" required="Y" />
    <field name="AccountInfoIDType" required="N" />
    <field name="PartyIDSource" required="N" />
    <field name="PartyRole" required="N" />
    <field name="PartyTransType" required="N" />
    <field name="PreferIndicator" required="N" />
    <field name="UserStatus" required="N" />
    <component name="AccountInfoGrp" required="N" />
    <component name="ContactInfoGrp" required="N" />
    <component name="PrvlgeGrp" required="N" />
    <component name="PtysSubGrp" required="N" />
  </group>
</component>
<component name="PartyListGrp" description="">
  <group name="NoPartyList" required="N">

```



```

    <field name="PartyID" required="Y" />
    <field name="PartyRole" required="N" />
    <field name="PartyStatus" required="N" />
    <component name="PtysSubGrp" required="N" />
    <component name="RiskLimits" required="N" />
  </group>
</component>
<component name="PositionAmountData" description="">
  <group name="NoPosAmt" required="N">
    <field name="PosAmt" required="Y" />
    <field name="AvailableAmt" required="N" />
    <field name="PosAmtType" required="N" />
    <field name="SecurityID" required="N" />
  </group>
</component>
<component name="PrvlgeGrp" description="">
  <group name="NoPrvlges" required="N">
    <field name="PrvlgeCategory" required="Y" />
    <field name="MarketIndicator" required="N" />
    <field name="PrvlgeIndicator" required="N" />
    <field name="QuoteType" required="N" />
    <field name="Side" required="N" />
    <field name="TradeMethod" required="N" />
  </group>
</component>
<component name="PtysSubGrp" description="">
  <group name="NoPartySubIDs" required="N">
    <field name="PartySubID" required="Y" />
    <field name="Description" required="N" />
    <field name="PartySubIDType" required="N" />
  </group>
</component>
<component name="QueryParamGrp" description="">
  <group name="NoQueryParam" required="N">
    <field name="QueryParamType" required="Y" />
    <field name="QueryParamValue" required="N" />
  </group>
</component>
<component name="QueryResultGrp" description="">
  <group name="NoQueryResult" required="N">
    <field name="QueryResultValue" required="Y" />
    <field name="QueryResultType" required="N" />
  </group>

```

```

</component>
<component name="QuotEntryGrp" description="">
  <group name="NoQuoteEntries" required="N">
    <component name="Instrument" required="Y" />
    <field name="AutoQuoteIndicator" required="N" />
    <field name="Price" required="N" />
    <field name="PriceType" required="N" />
    <field name="QuoteEntryID" required="N" />
    <field name="SettlDate" required="N" />
    <field name="TimeToLive" required="N" />
    <field name="ValidUntilTime" required="N" />
    <component name="LegQuotGrp" required="N" />
    <component name="OrderQtyData" required="N" />
  </group>
</component>
<component name="QuotReqGrp" description="">
  <group name="NoRelatedSym" required="N">
    <component name="Instrument" required="Y" />
    <field name="BaseAmountDPS" required="N" />
    <field name="BidForwardPoints" required="N" />
    <field name="BidPx" required="N" />
    <field name="BidSpotRate" required="N" />
    <field name="CalculatedCcyLastQty" required="N" />
    <field name="Currency" required="N" />
    <field name="DecimalPlaces" required="N" />
    <field name="ForwardScaleDecimalPlaces" required="N" />
    <field name="FWDecimalPlaces" required="N" />
    <field name="NDFCurrency" required="N" />
    <field name="NDFDate" required="N" />
    <field name="OfferForwardPoints" required="N" />
    <field name="OfferPx" required="N" />
    <field name="OfferSpotRate" required="N" />
    <field name="Reference" required="N" />
    <field name="RiskCurrency" required="N" />
    <field name="RiskLastQty" required="N" />
    <field name="RoundDownCurrencies" required="N" />
    <field name="SettlDate" required="N" />
    <field name="SettlType" required="N" />
    <field name="Side" required="N" />
    <field name="SpotDate" required="N" />
    <field name="TermAmountDPS" required="N" />
    <field name="TimeToLive" required="N" />
    <field name="TransactTime" required="N" />
  </group>
</component>

```

```

    <component name="OrderQtyData" required="N" />
    <component name="Parties" required="N" />
    <component name="QuotReqLegsGrp" required="N" />
  </group>
</component>
<component name="QuotReqLegsGrp" description="">
  <group name="NoLegs" required="N">
    <component name="InstrumentLeg" required="Y" />
    <field name="LegBidForwardPoints" required="N" />
    <field name="LegBidPx" required="N" />
    <field name="LegCalculatedCcyLastQty" required="N" />
    <field name="LegOfferForwardPoints" required="N" />
    <field name="LegOfferPx" required="N" />
    <field name="LegOrderQty" required="N" />
    <field name="LegRiskOrderQty" required="N" />
    <field name="LegSettlDate" required="N" />
    <field name="LegSettlType" required="N" />
    <field name="LegSpotDate" required="N" />
  </group>
</component>
<component name="QuotSetGrp" description="">
  <group name="NoQuoteSets" required="N">
    <field name="QuoteSetID" required="Y" />
    <field name="QuoteTime" required="N" />
    <component name="Parties" required="N" />
    <component name="QuotEntryGrp" required="N" />
  </group>
</component>
<component name="RateBaseInfo" description="">
  <group name="NoRateBaseInfo" required="N">
    <field name="Currency" required="N" />
    <field name="CurrentFXRate" required="N" />
  </group>
</component>
<component name="RatioDataGrp" description="">
  <group name="NoRatioData" required="N">
    <field name="SetRatio" required="Y" />
    <field name="AvailableRatio" required="N" />
    <field name="EffectiveTime" required="N" />
    <field name="SecurityID" required="N" />
    <field name="Symbol" required="N" />
    <field name="UtilizedRatio" required="N" />
  </group>
</component>

```

```

</component>
<component name="RedemptionInfoGrp" description="">
  <group name="NoRedemptionInfo" required="N">
    <field name="RedemptionType" required="Y" />
    <field name="RedemptionDate" required="N" />
    <field name="RedemptionOfFaceValue" required="N" />
    <field name="RedemptionPx" required="N" />
    <field name="RedemptionRatio" required="N" />
    <field name="RedemptionSequence" required="N" />
  </group>
</component>
<component name="ReissueEvtGrp" description="">
  <group name="NoReissueEvents" required="N">
    <field name="ReissueEventType" required="Y" />
    <field name="ReissueEventDate" required="N" />
  </group>
</component>
<component name="ReissueInfoGrp" description="">
  <group name="NoReissueInfo" required="N">
    <field name="ReissueDate" required="Y" />
    <field name="ReissueMethod" required="N" />
    <field name="ReissueOfferMethod" required="N" />
    <field name="ReissuePx" required="N" />
    <field name="ReissueSize" required="N" />
    <field name="ReissueSizeForPlan" required="N" />
    <component name="ReissueEvtGrp" required="N" />
    <component name="Stipulations" required="N" />
  </group>
</component>
<component name="RiskLimits" description="">
  <group name="NoRiskLimits" required="N">
    <field name="RiskLimitAmount" required="Y" />
    <field name="CNYTradedIndic" required="N" />
    <field name="RiskLimitType" required="N" />
  </group>
</component>
<component name="RoutingGrp" description="">
  <group name="NoRoutingIDs" required="N">
    <field name="RoutingType" required="Y" />
    <field name="RoutingID" required="N" />
  </group>
</component>
<component name="SecAltIDGrp" description="">

```

```

<group name="NoSecurityAltID" required="N">
  <field name="SecurityAltID" required="Y" />
  <field name="SecurityAltIDSource" required="N" />
</group>
</component>
<component name="SecListGrp" description="">
  <group name="NoRelatedSym" required="N">
    <component name="Instrument" required="Y" />
    <field name="Currency" required="N" />
    <field name="DayCount" required="N" />
    <field name="MinTradeVol" required="N" />
  </group>
</component>
<component name="SecLstUpdRelSymGrp" description="">
  <group name="NoRelatedSym" required="N">
    <component name="Instrument" required="Y" />
    <field name="Currency" required="N" />
    <field name="DayCount" required="N" />
    <field name="EffectiveTime" required="N" />
    <field name="ExpireTime" required="N" />
    <component name="SpreadOrBenchmarkCurveData" required="N" />
  </group>
</component>
<component name="SettlCurrGrp" description="">
  <group name="NoCurrencies" required="N">
    <field name="SettlCurrency" required="Y" />
    <field name="BuyWeightedPX" required="N" />
    <field name="CCYSettlBank" required="N" />
    <field name="SellWeightedPX" required="N" />
    <field name="SettlCurrAmt" required="N" />
    <field name="SettlDate" required="N" />
  </group>
</component>
<component name="SettlCurrPairsGrp" description="">
  <group name="NoCurrPairs" required="N">
    <field name="SecurityID" required="Y" />
    <component name="SettlExecGrp" required="N" />
  </group>
</component>
<component name="SettlDetails" description="">
  <group name="NoSettlDetails" required="N">
    <field name="SettlCurrAmt" required="Y" />
    <field name="OrderQty" required="N" />
  </group>
</component>

```

```

    <component name="SettlParties" required="N" />
  </group>
</component>
<component name="SettlExecGrp" description="">
  <group name="NoSettlExecs" required="N">
    <field name="ExecID" required="Y" />
    <field name="BuyContraCCYAmt" required="N" />
    <field name="BuyDealCCYAmt" required="N" />
    <field name="CPConfStatus" required="N" />
    <field name="Currency" required="N" />
    <field name="Price" required="N" />
    <field name="SelfConfStatus" required="N" />
    <field name="SellContraCCYAmt" required="N" />
    <field name="SellDealCCYAmt" required="N" />
    <field name="SettlExecStatus" required="N" />
    <field name="Text" required="N" />
    <field name="TradeDate" required="N" />
    <field name="TradeTime" required="N" />
    <component name="Parties" required="N" />
  </group>
</component>
<component name="SettlObligationInstruction" description="">
  <group name="NoSettlOblig" required="N">
    <field name="SettlCurrency" required="Y" />
    <field name="ClearingBusinessDate" required="N" />
    <field name="CurrNumOfTot" required="N" />
    <field name="DeliveryType" required="N" />
    <field name="EffectiveTime" required="N" />
    <field name="ExecID" required="N" />
    <field name="ExpireTime" required="N" />
    <field name="LastQty" required="N" />
    <field name="LastRptRequested" required="N" />
    <field name="LegInfrmnIndicator" required="N" />
    <field name="NetGrossInd" required="N" />
    <field name="PaySettledCount" required="N" />
    <field name="PayTotalSettlAmt" required="N" />
    <field name="RecSettledCount" required="N" />
    <field name="RecTotalSettlAmt" required="N" />
    <field name="SettlCurrAmt" required="N" />
    <field name="SettlDate" required="N" />
    <field name="SettlementStatus" required="N" />
    <field name="SettlObligID" required="N" />
    <field name="SettlObligRefID" required="N" />
  </group>
</component>

```

```

    <field name="SettlObligTransType" required="N" />
    <field name="SettlTime" required="N" />
    <field name="Side" required="N" />
    <field name="TradeDate" required="N" />
    <component name="Instrument" required="N" />
    <component name="Parties" required="N" />
    <component name="SettlDetails" required="N" />
  </group>
</component>
<component name="SettlParties" description="">
  <group name="NoSettlPartyIDs" required="N">
    <field name="SettlPartyID" required="Y" />
    <field name="SettlPartyRole" required="N" />
    <component name="SettlPtysSubGrp" required="N" />
  </group>
</component>
<component name="SettlPtysSubGrp" description="the settlement member's detail
information, especial account information.">
  <group name="NoSettlParty" required="N">
    <field name="SettlPartySubID" required="Y" />
    <field name="SettlPartySubIDType" required="N" />
  </group>
</component>
<component name="SpreadOrBenchmarkCurveData" description="">
  <field name="BenchmarkCurveName" required="Y" />
  <field name="BenchmarkCurveCurrency" required="N" />
  <field name="BenchmarkCurvePoint" required="N" />
  <field name="BenchmarkPrice" required="N" />
  <field name="BenchmarkResetFrequency" required="N" />
  <field name="CouponCapRate" required="N" />
  <field name="CouponFloorRate" required="N" />
  <field name="FloatRateInd" required="N" />
  <field name="Spread" required="N" />
</component>
<component name="StandardHeader" description="">
  <field name="BeginString" required="Y" />
  <field name="BodyLength" required="Y" />
  <field name="MsgSeqNum" required="Y" />
  <field name="MsgType" required="Y" />
  <field name="SenderCompID" required="Y" />
  <field name="SendingTime" required="Y" />
  <field name="TargetCompID" required="Y" />
  <field name="DeliverToCompID" required="N" />

```

```

<field name="DeliverToSubID" required="N" />
<field name="ErrorCode" required="N" />
<field name="LastMsgSeqNumProcessed" required="N" />
<field name="MessageEncoding" required="N" />
<field name="OnBehalfOfCompID" required="N" />
<field name="OnBehalfOfSubID" required="N" />
<field name="OrigSendingTime" required="N" />
<field name="PossDupFlag" required="N" />
<field name="PossResend" required="N" />
<field name="SecureData" required="N" />
<field name="SecureDataLen" required="N" />
<field name="SegmentID" required="N" />
<field name="SenderSubID" required="N" />
<field name="SignatureMethod" required="N" />
<field name="SysSeqNo" required="N" />
<field name="TargetSubID" required="N" />
<field name="UserSeqNo" required="N" />
<component name="HopsGroup" required="N" />
</component>
<component name="StandardTrailer" description="">
  <field name="Checksum" required="Y" />
  <field name="Signature" required="N" />
  <field name="SignatureLength" required="N" />
</component>
<component name="Stipulations" description="">
  <group name="NoStipulations" required="N">
    <field name="StipulationType" required="Y" />
    <field name="StipulationValue" required="N" />
  </group>
</component>
<component name="StubGrp" description="">
  <group name="NoStub" required="N">
    <field name="StubIndicator" required="Y" />
    <field name="StubDescription" required="N" />
    <field name="StubEndDate" required="N" />
    <field name="StubInterestPaymentDate" required="N" />
    <field name="StubRateFixedDate" required="N" />
    <field name="StubRateFixedDate2" required="N" />
    <field name="StubStartDate" required="N" />
  </group>
</component>
<component name="SwapBondDates" description="">
  <group name="NoSwapBondDates" required="N">

```



```

    <field name="SwapBondOperDate" required="Y" />
    <field name="SwapBondAppFrom" required="N" />
    <field name="SwapBondAppTo" required="N" />
    <field name="SwapBondRatio" required="N" />
  </group>
</component>
<component name="SwapBondGrp" description="">
  <group name="NoSwapBonds" required="N">
    <field name="SwapBondSymbol" required="Y" />
    <field name="SwapBondID" required="N" />
    <component name="SwapBondDates" required="N" />
  </group>
</component>
<component name="TradeFeeGrp" description="">
  <group name="NoTradeFees" required="N">
    <field name="ExecID" required="Y" />
    <field name="MarketIndicator" required="N" />
    <field name="OrderQty" required="N" />
    <field name="Side" required="N" />
    <field name="TradeDate" required="N" />
    <component name="MiscFeesGrp" required="N" />
    <component name="Parties" required="N" />
  </group>
</component>
<component name="TrdCapRptSideGrp" description="">
  <group name="NoSides" required="Y">
    <field name="Side" required="Y" />
    <field name="CLOrdID" required="N" />
    <field name="DealSerialNo" required="N" />
    <field name="OrderID" required="N" />
    <field name="QuoteID" required="N" />
    <field name="QuoteRespID" required="N" />
    <field name="SettlCurrAmt" required="N" />
    <field name="SettlCurrAmt2" required="N" />
    <field name="TradeCashAmt" required="N" />
    <field name="TradeType" required="N" />
    <field name="TradingSessionID" required="N" />
    <component name="MarginInfoGrp" required="N" />
    <component name="Parties" required="N" />
  </group>
</component>
<component name="TrdRptGrp" description="">
  <group name="NoTrdReports" required="N">

```

```

    <field name="ExecID" required="Y" />
    <field name="DealID" required="N" />
    <field name="LastPx" required="N" />
    <field name="LastQty" required="N" />
    <field name="MarginRequired" required="N" />
    <field name="SettlDate" required="N" />
    <field name="SettlDate2" required="N" />
    <field name="TradeDate" required="N" />
    <field name="TradeFwdDays" required="N" />
    <field name="TradeLimitDays" required="N" />
    <field name="TradeReportTransType" required="N" />
    <field name="TradeTime" required="N" />
    <component name="FinancingDetails" required="N" />
    <component name="Instrument" required="N" />
    <component name="OrderQtyData" required="N" />
    <component name="TrdCapRptSideGrp" required="N" />
    <component name="UndInstrmtGrp" required="N" />
  </group>
</component>
<component name="UnderlyingInstrument" description="">
  <field name="UnderlyingSecurityID" required="Y" />
  <field name="TermToMaturity" required="N" />
  <field name="UnderlyingAccruedInterestAmt" required="N" />
  <field name="UnderlyingAccruedInterestAmt2" required="N" />
  <field name="UnderlyingCashSubOpt" required="N" />
  <field name="UnderlyingCashSubPremRatio" required="N" />
  <field name="UnderlyingCouponPaymentDate" required="N" />
  <field name="UnderlyingCouponRate" required="N" />
  <field name="UnderlyingCreditRating" required="N" />
  <field name="UnderlyingCurrency" required="N" />
  <field name="UnderlyingDirtyPrice" required="N" />
  <field name="UnderlyingDirtyPrice2" required="N" />
  <field name="UnderlyingDiscountAmt" required="N" />
  <field name="UnderlyingFaceValue" required="N" />
  <field name="UnderlyingFundManager" required="N" />
  <field name="UnderlyingIssueDate" required="N" />
  <field name="UnderlyingIssuer" required="N" />
  <field name="UnderlyingIssueSize" required="N" />
  <field name="UnderlyingMaturityDate" required="N" />
  <field name="UnderlyingPx" required="N" />
  <field name="UnderlyingPx2" required="N" />
  <field name="UnderlyingQty" required="N" />
  <field name="UnderlyingRedemQty" required="N" />

```

```

<field name="UnderlyingSecurityDesc" required="N" />
<field name="UnderlyingSecurityIDSource" required="N" />
<field name="UnderlyingSecurityType" required="N" />
<field name="UnderlyingSubQty" required="N" />
<field name="UnderlyingSymbol" required="N" />
<field name="UnderlyingTotalCashSubAmt" required="N" />
<component name="UnderlyingStipulations" required="N" />
</component>
<component name="UnderlyingStipulations" description="">
  <group name="NoUnderlyingStips" required="N">
    <field name="UnderlyingStipType" required="Y" />
    <field name="UnderlyingStipValue" required="N" />
  </group>
</component>
<component name="UnderwriterInfoGrp" description="">
  <group name="NoUnderwriter" required="N">
    <field name="UnderwriterType" required="Y" />
    <field name="UnderwriterName" required="N" />
  </group>
</component>
<component name="UndInstrmtGrp" description="">
  <group name="NoUnderlyings" required="N">
    <component name="UnderlyingInstrument" required="Y" />
  </group>
</component>
<component name="YieldCurveGrp" description="">
  <group name="NoYields" required="N">
    <field name="YieldTerm" required="Y" />
    <component name="CurvePxGrp" required="N" />
  </group>
</component>
<component name="YieldData" description="">
  <field name="Yield" required="N" />
  <field name="YieldType" required="N" />
</component>
</components>
<fields>
  <field number="7" name="BeginSeqNo" description="Message sequence number of
first message in range to be resent" type="SEQNUM" />
  <field number="8" name="BeginString" description="Identifies beginning of new
message and protocol version. ALWAYS FIRST FIELD IN MESSAGE" type="STRING">
    <value enum="IMIX.1.0" description="BEGINSTRING_VALUE_IMIX10" />
  </field>

```

```

    <field number="9" name="BodyLength" description="Message length; in bytes;
forward to the CheckSum field. ALWAYS SECOND FIELD IN MESSAGE." type="LENGTH" />
    <field number="10" name="CheckSum" description="Three byte; simple checksum
(&quot;Checksum Calculation&quot; for description). ALWAYS LAST FIELD IN
MESSAGE with the trailing ; as the end-of-message delimiter. Always defined as
three characters. (Always unencrypted)" type="STRING" />
    <field number="11" name="ClOrdID" description="client reference identity"
type="STRING" />
    <field number="15" name="Currency" description="Identifies currency used for
trading. Absence of this field is interpreted as the default for the security.
The default is CNY" type="CURRENCY" />
    <field number="16" name="EndSeqNo" description="Message sequence number of
last message in range to be resent" type="SEQNUM" />
    <field number="17" name="ExecID" description="Deal Number" type="STRING" />
    <field number="18" name="ExecInst" description="Type Of Order - Amount"
type="MULTIPLEVALUESTRING">
        <value enum="G" description="ALL_OR_NONE_ORDER" />
        <value enum="101" description="ICEBERG_ORDER" />
        <value enum="102" description="MINIMUM_FILL_ORDER" />
        <value enum="103" description="FILL_OR_KILL_ORDER" />
    </field>
    <field number="22" name="SecurityIDSSource" description="Required if
SecurityID is specified." type="STRING">
        <value enum="5" description="RIC_CODE" />
        <value enum="101" description="CFETS" />
        <value enum="102" description="CDC" />
        <value enum="103" description="USERDEFINED" />
    </field>
    <field number="23" name="IOIID" description="IOI Quote Number" type="STRING"
/>
    <field number="27" name="IOIQty" description="(e.g. number of shares) in
numeric form or relative size" type="STRING" />
    <field number="28" name="IOITransType" description="Indicative Transaction
Type&#xA;N-New; C-Cancelled; R-Replaced" type="CHAR">
        <value enum="N" description="NEW" />
        <value enum="C" description="CANCELLED" />
        <value enum="R" description="REPLACED" />
    </field>
    <field number="31" name="LastPx" description="Latest Clean price" type="PRICE"
/>
    <field number="32" name="LastQty" description="Traded Quantity&#xA;(e.g.
shares) bought/sold on this (last) fill" type="QTY" />
    <field number="34" name="MsgSeqNum" description="Integer message sequence

```

```

number used for session management" type="SEQNUM" />
<field number="35" name="MsgType" description="Message Type" type="STRING">
  <value enum="0" description="HEARTBEAT" />
  <value enum="1" description="TEST_REQUEST" />
  <value enum="2" description="RESEND_REQUEST" />
  <value enum="3" description="REJECT" />
  <value enum="4" description="SEQUENCE_RESET" />
  <value enum="5" description="LOGOUT" />
  <value enum="6" description="INDICATION_OF_INTEREST" />
  <value enum="8" description="EXECUTION_REPORT" />
  <value enum="9" description="ORDER_CANCEL_REJECT" />
  <value enum="A" description="LOGON" />
  <value enum="D" description="NEW_ORDER_SINGLE" />
  <value enum="F" description="ORDER_CANCEL_REQUEST" />
  <value enum="G" description="ORDER_CANCEL_OR_REPLACE_REQUEST" />
  <value enum="g" description="TRADINGSESSIONSTATUSREQUEST" />
  <value enum="S" description="QUOTE" />
  <value enum="Z" description="QUOTE_CANCEL_A_QUOTE_STATUS_REQUEST" />
  <value enum="AB" description="NEWORDERMULTILEG" />
  <value enum="AG" description="QUOTEREQUESTREJECT" />
  <value enum="AI" description="QUOTE_STATUS_REPORT" />
  <value enum="AJ" description="QUOTE_RESPONSE" />
  <value enum="AK" description="CONFIRMATION" />
  <value enum="AU" description="CONFIRMATION_ACK" />
  <value enum="BE" description="USER_REQUEST" />
  <value enum="BF" description="USER_RESPONSE" />
  <value enum="BH" description="CONFIRMATIONREQUEST" />
  <value enum="j" description="BUSINESS_MESSAGE_REJECT" />
  <value enum="h" description="TRADING_SESSION_STATUS" />
  <value enum="x" description="SECURITYLISTREQUEST" />
  <value enum="y" description="SECURITYLIST" />
  <value enum="U02" description="QUERY_REQUEST" />
  <value enum="U03" description="TRADE_CONTROL_REPORT" />
  <value enum="U04" description="QUERYREJECT" />
  <value enum="U06" description="DATA_DOWNLOAD_REQUEST" />
  <value enum="AE" description="TRADE_CAPTURE_REPORT" />
  <value enum="d" description="SECURITY_DEFINITION" />
  <value enum="i" description="MASS_QUOTE" />
  <value enum="W" description="MARKETDATA_SNAPSHOT_FULLREFRESH" />
  <value enum="BN" description="EXECUTION_ACKNOWLEDGEMENT" />
  <value enum="CF" description="PARTYDETAILSLISTREQUEST" />
  <value enum="CG" description="PARTYDETAILSLISTREPORT" />
  <value enum="U01" description="QUERYRESULT" />

```

```

<value enum="U07" description="DATADOWNLOADRESPONSE" />
<value enum="V" description="MARKETDATAREQUEST" />
<value enum="U08" description="BREAKCONTRACTREQUEST" />
<value enum="U09" description="BREAKCONTRACTREQUESTACK" />
<value enum="U10" description="COLLATERALDRAWREQUEST" />
<value enum="U11" description="COLLATERALDRAWREQUESTACK" />
<value enum="U12" description="COLLATERALDRAWRESPONSE" />
<value enum="U13" description="COLLATERALDRAWRESPONSEACK" />
<value enum="U14" description="COLLATERALINFOCHANGE" />
<value enum="U15" description="COLLATERALINFOCHANGEACK" />
<value enum="U16" description="MASSTRDREPORT" />
<value enum="AR" description="TRADECAPTUREREPORTACK" />
<value enum="U17" description="MASSTRDREPORTACK" />
<value enum="U18" description="ORDDISPLAY" />
<value enum="U19" description="TADEFEEINFO" />
<value enum="U20" description="QUICKCANCEL" />
<value enum="U21" description="QUICKCANCELSTATUSREPORT" />
<value enum="U22" description="PARTYINFO" />
<value enum="R" description="QUOTEREQUEST" />
<value enum="U26" description="LIMITINFO" />
<value enum="U27" description="SUBSCRIBEQUEST" />
<value enum="U28" description="COLLATERALINFOCHANGEREQUEST" />
<value enum="U29" description="QUOTEREQUESTACK" />
<value enum="X" description="MARKETDATAINCREMENTALREFRESH" />
<value enum="U30" description="QUOTEACK" />
<value enum="U31" description="SETTLOBLIGATIONREPORTACK" />
<value enum="U32" description="QUOTEREQUESTCANCEL" />
<value enum="AV" description="SETTLEMENTINSTRUCTIONREQUEST" />
<value enum="BQ" description="SETTLEMENTOBLIGATIONREPORT" />
<value enum="U33" description="SETTLEMENTDETAILREPORT" />
<value enum="U34" description="SETTLEMENTDETAILREPORTACK" />
<value enum="AY" description="COLLATERALASSIGNMENT" />
<value enum="U37" description="COLLATERALASSIGNMENTACK" />
<value enum="BK" description="SECURITYLISTUPDATEDREPORT" />
<value enum="U38" description="SECLISTUPDREPORTACK" />
<value enum="U39" description="PARTYINFOACK" />
<value enum="U40" description="SECURITYLISTUPDREQUEST" />
<value enum="U35" description="COLLATERALDETAILREPORT" />
<value enum="U36" description="COLLATERALDETAILREPORTACK" />
<value enum="BB" description="COLLATERALINQUIRY" />
<value enum="U41" description="SETTREPCONFIRM" />
<value enum="U42" description="COLLATERALDPDTLREPORT" />
<value enum="U43" description="COLLATERALDPINQUIRY" />

```

```

<value enum="U44" description="COLLATERALDPDTLRPTACK" />
<value enum="H" description="ORDERSTATUSREQUEST" />
<value enum="U46" description="COLLDRAWCANCELREQUEST" />
<value enum="U47" description="COLLASSIGNMENTRESPONSE" />
<value enum="U48" description="COLLTRANSFERREQUEST" />
<value enum="U49" description="COLLTRANSFERREQUESTACK" />
<value enum="U50" description="COLLTRANSFERRESPONSE" />
<value enum="U51" description="COLLTRANSFERRESPONSEACK" />
<value enum="U52" description="COLLATERALBASEINFO" />
<value enum="U53" description="COLLATERALBASEINFOREQUEST" />
<value enum="U54" description="COLLATERALARINQUIRY" />
<value enum="U55" description="COLLATERALARDTLREPORT" />
<value enum="U56" description="COLLATERALARDTLRPTACK" />
<value enum="U57" description="COLLDRAWCANCELRESPONSEACK" />
<value enum="U58" description="SETTREPCONINQUIRY" />
<value enum="U59" description="COLLATERALBASEINFOACK" />
<value enum="U60" description="HOLDREQUEST" />
<value enum="U61" description="COLLASSIGNMENTRESPONSEACK" />
<value enum="U62" description="BULLETININQUIRY" />
<value enum="U63" description="BULLETINREPORT" />
<value enum="U64" description="BULLETINREPORTACK" />
<value enum="U65" description="SETTLEDETAILREQUEST" />
<value enum="U66" description="SETTREPCONFIRMACK" />
<value enum="U67" description="COLLDRAWCANCELRESPONSE" />
<value enum="U68" description="SECURITYLISTREQUESTACK" />
<value enum="U69" description="SECURITYLISTACK" />
<value enum="U70" description="LIMITINFOACK" />
<value enum="U71" description="FUNDVALUERPT" />
<value enum="U72" description="FUNDVALUERPTACK" />
<value enum="U73" description="TRADINGSESSIONSTATUSACK" />
<value enum="U74" description="MARKETDATAACK" />
<value enum="F01" description="FREEFORMATMESSAGE" />
<value enum="U75" description="SECURITYDEFINITIONACK" />
<value enum="AP" description="POSITIONREPORT" />
<value enum="A01" description="JOURNALENTYREQUEST" />
<value enum="A02" description="JOURNALENTY" />
<value enum="A03" description="JOURNALENTYACK" />
<value enum="U76" description="SUBSCRIBEREQUESTACK" />
<value enum="U77" description="REMINDER" />
</field>
<field number="36" name="NewSeqNo" description="New Sequence Number"
type="SEQNUM" />
<field number="37" name="OrderID" description="Order number" type="STRING" />

```



```

<field number="38" name="OrderQty" description="Order Quantity" type="QTY" />
<field number="39" name="OrdStatus" description="Order Status" type="CHAR">
  <value enum="0" description="NEW" />
  <value enum="1" description="PARTIALLY_FILLED" />
  <value enum="2" description="FILLED" />
  <value enum="3" description="PENDING_NEW" />
  <value enum="4" description="CANCELED" />
  <value enum="5" description="REPLACED" />
  <value enum="6" description="STOPPED" />
  <value enum="7" description="EXPIRED" />
  <value enum="8" description="CANCELLED_DUE_TO_ASSET_SUSPENSION" />
  <value enum="9" description="CANCELLED_DUE_TO_PRODUCT_SUSPENSION" />
  <value enum="A" description="CANCELLED_DUE_TO_USER_SUSPENSION" />
  <value enum="B" description="CANCELLED_DUE_TO_ENTITY_SUSPENSION" />
  <value enum="C" description="MINIMUM_FILL_CANCELLED" />
  <value enum="D" description="REJECT" />
</field>
<field number="40" name="OrdType" description="Type Of Order - Price"
type="CHAR">
  <value enum="1" description="MARKET" />
  <value enum="2" description="LIMIT" />
  <value enum="3" description="STOP_OR_STOP_LOSS" />
  <value enum="A" description="MARKET_ON_CLOSE" />
  <value enum="B" description="STOP_LOSS_LIMIT" />
  <value enum="C" description="STOP_LOSS_MARKET" />
  <value enum="a" description="RFQ" />
  <value enum="b" description="ONE_CLICK" />
  <value enum="c" description="TAKE_PROFIT" />
</field>
<field number="43" name="PossDupFlag" description="Possible Duplicate Flag
&#xA;Indicates possible retransmission of message with this sequence number"
type="BOOLEAN">
  <value enum="N" description="ORIGINAL_TRANSMISSION" />
  <value enum="Y" description="POSSIBLE_DUPLICATE" />
</field>
<field number="44" name="Price" description="Trading Price
&#xA;Rate&#xA;Fixed Rate&#xA;Clean Price&#xA;Fund Price&#xA;Security Lending
rate&#xA;Repo Rate" type="PRICE" />
<field number="45" name="RefSeqNum" description="Reference message sequence
number" type="SEQNUM" />
<field number="48" name="SecurityID" description="Instrument Code or Standard
Product Code" type="STRING" />
<field number="49" name="SenderCompID" description="Sender Company Identifier

```



```

&#xA;Assigned value used to identify member bank sending message." type="STRING"
/>
  <field number="50" name="SenderSubID" description="Sender
Sub-Identifer&#xA;Assigned value used to identify specific message originator
(desk, trader, etc.)" type="STRING" />
  <field number="52" name="SendingTime" description="Time of message
transmission (GMT+8)" type="UTCTIMESTAMP" />
  <field number="53" name="Quantity" description="Overall/total quantity"
type="QTY" />
  <field number="54" name="Side" description="Trading Direction" type="CHAR">
    <value enum="0" description="ALL" />
    <value enum="1"
description="BUY_OR_BORROW_OR_REVERSE_REPO_OR_FIXED_PAYER_OR_BENCHMARK_1_PAYE
R" />
    <value enum="4"
description="SELL_OR_LEND_OR_REPO_OR_FIXED_RECEIVER_OR_BENCHMARK_1_RECEIVER"
/>
    <value enum="B" description="AS_DEFINED" />
    <value enum="H" description="BUY_AND_SELL" />
    <value enum="I" description="SELL_AND_BUY" />
    <value enum="J" description="FIXED_RATE_TO_FLOAT_RATE" />
    <value enum="K" description="FLOAT_RATE_TO_FLOAT_RATE" />
    <value enum="1" description="BUY_OR_BORROW_OR_REPURCHASE" />
    <value enum="4" description="SELL_OR_LEND_OR_REVERSE_REPURCHASE" />
    <value enum="P" description="PAY" />
    <value enum="R" description="RECEIVE" />
    <value enum="C" description="CREDIT" />
    <value enum="D" description="DEBIT" />
  </field>
  <field number="55" name="Symbol" description="Trade Product Name or Currency
Pair Name" type="STRING" />
  <field number="56" name="TargetCompID" description="Target Company Identifier
&#xA;Assigned value used to identify receiving member bank" type="STRING" />
  <field number="57" name="TargetSubID" description="Target Company
Sub-Identifier &#xA;Assigned value used to identify specific individual or unit
intended to receive message. &quot;ADMIN&quot;; reserved for administrative
messages not intended for a specific user." type="STRING" />
  <field number="58" name="Text" description="Remarks&#xA;At the time of
negotiation, trader has an option to enter some remark in the remark field in the
quote entry window. Remarks can be of maximum 100 Chinese characters." type="STRING"
/>
  <field number="59" name="TimeInForce" description="Type Of Order - Time"
type="STRING">

```

```

    <value enum="0" description="DAY_OR_SESSION" />
    <value enum="1" description="GOOD_TILL_CANCEL" />
    <value enum="3" description="IMMEDIATE_OR_CANCEL" />
    <value enum="6" description="GOOD_TILL_DATE" />
    <value enum="101" description="GOOD_TILL_DAY" />
    <value enum="102" description="GOOD_TILL_TIME" />
</field>
<field number="60" name="TransactTime" description="TransactTime"
type="UTCTIMESTAMP" />
    <field number="62" name="ValidUntilTime" description="Valid Time for
Quotation" type="UTCTIMESTAMP" />
    <field number="63" name="SettlType" description="Settlement Speed&#xA;Valid
Values:&#xA;0 - Regular&#xA;1 - Cash(TOD / T+0)&#xA;2 - Next Day(TOM / T+1)&#xA;3
- T+2&#xA;4 - T+3&#xA;5 - T+4&#xA;6 - Future&#xA;7 - When And If Issued&#xA;8 -
Sellers Option&#xA;9 - T+5&#xA;ON, TODAY, TN, TOM, SPOT, 1D, SN, 1W, 2W, 3W, 1M,
2M, 3M , 4M, 5M, 6M, 9M, 1Y,
18M,BROKEN;&#xA;7D;2Y;3Y;4Y;5Y;6Y;7Y;8Y;9Y;10Y;11Y;12Y;13Y;14Y;15Y;16Y;17Y;18
Y;19Y;20Y;21Y;22Y;23Y;24Y;25Y;26Y;27Y;28Y;29Y;30Y;40Y;50Y" type="STRING">
    <value enum="0" description="REGULAR" />
    <value enum="1" description="CASH_OR_TOD_OR_T_PLUS_0" />
    <value enum="2" description="NEXT_DAY_OR_TOM_OR_T_PLUS_1" />
    <value enum="3" description="T_PLUS_2" />
    <value enum="4" description="T_PLUS_3" />
    <value enum="5" description="T_PLUS_4" />
    <value enum="6" description="FUTURE" />
    <value enum="7" description="WHEN_AND_IF_ISSUED" />
    <value enum="8" description="SELLERS_OPTION" />
    <value enum="9" description="T_PLUS_5" />
    <value enum="ON" description="LEGSETTLTYPE_VALUE_ON" />
    <value enum="TODAY" description="LEGSETTLTYPE_VALUE_TODAY" />
    <value enum="TN" description="LEGSETTLTYPE_VALUE_TN" />
    <value enum="TOM" description="LEGSETTLTYPE_VALUE_TOM" />
    <value enum="SPOT" description="LEGSETTLTYPE_VALUE_SPOT" />
    <value enum="1D" description="LEGSETTLTYPE_VALUE_1D" />
    <value enum="SN" description="LEGSETTLTYPE_VALUE_SN" />
    <value enum="1W" description="LEGSETTLTYPE_VALUE_1W" />
    <value enum="2W" description="LEGSETTLTYPE_VALUE_2W" />
    <value enum="3W" description="LEGSETTLTYPE_VALUE_3W" />
    <value enum="4W" description="LEGSETTLTYPE_VALUE_4W" />
    <value enum="1M" description="LEGSETTLTYPE_VALUE_1M" />
    <value enum="2M" description="LEGSETTLTYPE_VALUE_2M" />
    <value enum="3M" description="LEGSETTLTYPE_VALUE_3M" />
    <value enum="4M" description="LEGSETTLTYPE_VALUE_4M" />

```

```
<value enum="5M" description="LEGSETTLTYPE_VALUE_5M" />
<value enum="6M" description="LEGSETTLTYPE_VALUE_6M" />
<value enum="7M" description="LEGSETTLTYPE_VALUE_7M" />
<value enum="8M" description="LEGSETTLTYPE_VALUE_8M" />
<value enum="9M" description="LEGSETTLTYPE_VALUE_9M" />
<value enum="10M" description="LEGSETTLTYPE_VALUE_10M" />
<value enum="11M" description="LEGSETTLTYPE_VALUE_11M" />
<value enum="1Y" description="LEGSETTLTYPE_VALUE_1Y" />
<value enum="18M" description="LEGSETTLTYPE_VALUE_18M" />
<value enum="BROKEN" description="LEGSETTLTYPE_VALUE_BROKEN" />
<value enum="7D" description="LEGSETTLTYPE_VALUE_7D" />
<value enum="2Y" description="LEGSETTLTYPE_VALUE_2Y" />
<value enum="3Y" description="LEGSETTLTYPE_VALUE_3Y" />
<value enum="4Y" description="LEGSETTLTYPE_VALUE_4Y" />
<value enum="5Y" description="LEGSETTLTYPE_VALUE_5Y" />
<value enum="6Y" description="LEGSETTLTYPE_VALUE_6Y" />
<value enum="7Y" description="LEGSETTLTYPE_VALUE_7Y" />
<value enum="8Y" description="LEGSETTLTYPE_VALUE_8Y" />
<value enum="9Y" description="LEGSETTLTYPE_VALUE_9Y" />
<value enum="10Y" description="LEGSETTLTYPE_VALUE_10Y" />
<value enum="11Y" description="LEGSETTLTYPE_VALUE_11Y" />
<value enum="12Y" description="LEGSETTLTYPE_VALUE_12Y" />
<value enum="13Y" description="LEGSETTLTYPE_VALUE_13Y" />
<value enum="14Y" description="LEGSETTLTYPE_VALUE_14Y" />
<value enum="15Y" description="LEGSETTLTYPE_VALUE_15Y" />
<value enum="16Y" description="LEGSETTLTYPE_VALUE_16Y" />
<value enum="17Y" description="LEGSETTLTYPE_VALUE_17Y" />
<value enum="18Y" description="LEGSETTLTYPE_VALUE_18Y" />
<value enum="19Y" description="LEGSETTLTYPE_VALUE_19Y" />
<value enum="20Y" description="LEGSETTLTYPE_VALUE_20Y" />
<value enum="21Y" description="LEGSETTLTYPE_VALUE_21Y" />
<value enum="22Y" description="LEGSETTLTYPE_VALUE_22Y" />
<value enum="23Y" description="LEGSETTLTYPE_VALUE_23Y" />
<value enum="24Y" description="LEGSETTLTYPE_VALUE_24Y" />
<value enum="25Y" description="LEGSETTLTYPE_VALUE_25Y" />
<value enum="26Y" description="LEGSETTLTYPE_VALUE_26Y" />
<value enum="27Y" description="LEGSETTLTYPE_VALUE_27Y" />
<value enum="28Y" description="LEGSETTLTYPE_VALUE_28Y" />
<value enum="29Y" description="LEGSETTLTYPE_VALUE_29Y" />
<value enum="30Y" description="LEGSETTLTYPE_VALUE_30Y" />
<value enum="40Y" description="LEGSETTLTYPE_VALUE_40Y" />
<value enum="50Y" description="LEGSETTLTYPE_VALUE_50Y" />
</field>
```

```

    <field number="64" name="SettlDate" description="Settlement Date/ 1st
settlement date" type="UTCDATEONLY" />
    <field number="75" name="TradeDate" description="Trade Date"
type="UTCDATEONLY" />
    <field number="89" name="Signature" description="Electronic signature"
type="DATA" />
    <field number="90" name="SecureDataLen" description="Length of encrypted
message" type="LENGTH" />
    <field number="91" name="SecureData" description="Actual encrypted data
stream" type="DATA" />
    <field number="93" name="SignatureLength" description="Number of bytes in
signature field." type="LENGTH" />
    <field number="95" name="RawDataLength" description="Number of bytes in raw
data field." type="LENGTH" />
    <field number="96" name="RawData" description="Unformatted raw data. can
include bitmaps. word processor documents. etc." type="DATA" />
    <field number="97" name="PossResend" description="Message Possible Resend Flag
&#xA;Indicates that message may contain information that has been sent under another
sequence number." type="BOOLEAN">
        <value enum="N" description="ORIGINAL_TRANSMISSION" />
        <value enum="Y" description="POSSIBLE_RESEND" />
    </field>
    <field number="98" name="EncryptMethod" description="Method of encryption.;
Valid values:; 0 - None or other; 1 - PKCS (proprietary); 2 - DES (ECB mode); 3
- PKCS or DES (proprietary); 4 - PGP or DES (defunct); 5 - PGP or DES-MD5 (see
app note on FIX web site); 6 - PEM or DES-MD5 (see app note on FIX web site)"
type="INT">
        <value enum="0" description="NONE_OR_OTHER" />
        <value enum="1" description="PKCS" />
        <value enum="2" description="DES" />
        <value enum="3" description="PKCS_OR_DES" />
        <value enum="4" description="PGP_OR_DES" />
        <value enum="5" description="PGP_OR_DES_MD5" />
        <value enum="6" description="PEM_OR_DES_MD5" />
    </field>
    <field number="99" name="StopPx" description="Trigger Price" type="PRICE" />
    <field number="103" name="OrdRejReason" description="Code to identify reason
for order rejection" type="INT">
        <value enum="0" description="BROKER_OPTION" />
        <value enum="1" description="UNKNOWN_SYMBOL" />
        <value enum="2" description="EXCHANGE_CLOSED" />
        <value enum="3" description="ORDER_EXCEEDS_LIMIT" />
        <value enum="4" description="TOO_LATE_TO_ENTER" />

```

```

    <value enum="5" description="UNKNOWN_ORDER" />
    <value enum="6" description="DUPLICATE_ORDER" />
    <value enum="7" description="DUPLICATE_OF_A_VERBALLY_COMMUNICATED_ORDER"
/>
    <value enum="8" description="STALE_ORDER" />
    <value enum="99" description="UNSPECIFIED" />
</field>
<field number="106" name="Issuer" description="Issuer Name" type="STRING" />
<field number="108" name="HeartBtInt" description="Heart Beat Interval"
type="INT" />
    <field number="110" name="MinQty" description="Minimum Trading Amount"
type="QTY" />
    <field number="111" name="MaxFloor" description="Maximum Display
Quantity(maximum display unit amount)" type="QTY" />
    <field number="112" name="TestReqID" description="Test Request Identifier
&#xA;Identifier included in Test Request message to be returned in resulting
Heartbeat" type="STRING" />
    <field number="115" name="OnBehalfOfCompID" description="Message Originator
&#xA;Assigned value used to identify firm originating message if the message was
delivered by a third party i.e. the third party member bank would be delivered
in the SenderCompID field and the firm originating the message in this field."
type="STRING" />
    <field number="116" name="OnBehalfOfSubID" description="Message Originator
Company Sub Identifier &#xA;Assigned value used to identify specific message
originator (i.e. trader) if the message was delivered by a third party"
type="STRING" />
    <field number="117" name="QuoteID" description="Quote Number" type="STRING"
/>
    <field number="118" name="NetMoney" description="" type="AMT" />
    <field number="119" name="SettlCurrAmt" description="Settlement Amount/ 1st
Leg Settlement Amount" type="AMT" />
    <field number="120" name="SettlCurrency" description="Settlement Currency or
1st-Leg Settlement Currency" type="CURRENCY" />
    <field number="122" name="OrigSendingTime" description="Original Message
Transmission Time &#xA;Original time of message transmission (GMT+8) when
transmitting orders as the result of a resend request." type="UTCTIMESTAMP" />
    <field number="123" name="GapFillFlag" description="Message Gap Fill Flag
&#xA;Indicates that the Sequence Reset message is replacing administrative or
application messages which will not be resent" type="BOOLEAN">
        <value enum="Y" description="YES" />
        <value enum="N" description="NO" />
</field>
    <field number="124" name="NoExecs" description="" type="NUMINGROUP" />

```

```

    <field number="126" name="ExpireTime" description="Quote Expire Time"
type="UTCTIMESTAMP" />
    <field number="127" name="DKReason" description="Reason for execution
rejection" type="CHAR">
        <value enum="A" description="UNKNOWN_SYMBOL" />
        <value enum="B" description="WRONG_SIDE" />
        <value enum="C" description="QUANTITY_EXCEEDS_ORDER" />
        <value enum="D" description="NO_MATCHING_ORDER" />
        <value enum="E" description="PRICE_EXCEEDS_LIMIT" />
        <value enum="F" description="CALCULATION_DIFFERENCE" />
        <value enum="Z" description="OTHER" />
    </field>
    <field number="128" name="DeliverToCompID" description="Message Target
Company Identifier &#xA;Assigned value used to identify the firm targeted to receive
the message if the message is delivered by a third party i.e. the third party firm
identifier would be delivered in the TargetCompID (56) field and the ultimate
receiver firm ID in this field." type="STRING" />
    <field number="129" name="DeliverToSubID" description="Message Target Company
Sub Identifier &#xA;Assigned value used to identify specific message recipient
(i.e. trader) if the message is delivered by a third party" type="STRING" />
    <field number="131" name="QuoteReqID" description="Unique identifier for quote
request" type="STRING" />
    <field number="132" name="BidPx" description="Bid price/rate" type="PRICE" />
    <field number="133" name="OfferPx" description="Offer price/rate"
type="PRICE" />
    <field number="136" name="NoMiscFees" description="Number of repeating groups
of miscellaneous fees" type="NUMINGROUP" />
    <field number="137" name="MiscFeeAmt" description="Miscellaneous fee value"
type="AMT" />
    <field number="138" name="MiscFeeCurr" description="Miscellaneous Fee
Curremcy" type="CURRENCY" />
    <field number="139" name="MiscFeeType" description="Miscellaneous fee type"
type="INT">
        <value enum="13" description="SECURITY_LENDING" />
        <value enum="100" description="TOTAL_FEE_APPLICABLE" />
        <value enum="101" description="FEE_APPLICABLE" />
        <value enum="102" description="OPTION_FEE" />
    </field>
    <field number="141" name="ResetSeqNumFlag" description="Message Sequence
Number Reset Flag &#xA;Indicates that the both sides of the FIX session should
reset sequence numbers" type="BOOLEAN">
        <value enum="Y" description="YES" />
        <value enum="N" description="NO" />

```

```

</field>
<field number="146" name="NoRelatedSym" description="Specifies the number of
repeating symbols specified." type="NUMINGROUP" />
<field number="150" name="ExecType" description="Execution Type"
type="STRING">
  <value enum="0" description="NEW" />
  <value enum="4" description="CANCELED" />
  <value enum="5" description="REPLACE" />
  <value enum="7" description="STOPPED" />
  <value enum="8" description="REJECTED" />
  <value enum="F" description="TRADE" />
  <value enum="H" description="TRADE_CANCEL" />
  <value enum="101" description="CONTINGENCY" />
  <value enum="I" description="ORDER_STATUS" />
</field>
<field number="152" name="CashOrderQty" description="Total Eligible Traded
Amount" type="QTY" />
<field number="158" name="AccruedInterestRate" description="Accrued Interest
Rate" type="PERCENTAGE" />
<field number="159" name="AccruedInterestAmt" description="Accrued Interest"
type="AMT" />
<field number="167" name="SecurityType" description="Security Type"
type="STRING">
  <value enum="0" description="TREASURY_BONDS" />
  <value enum="1" description="POLICY_FINANCIAL_BONDS" />
  <value enum="2" description="COMMERCIAL_PAPERS" />
  <value enum="3" description="SUBORDINATED_BONDS" />
  <value enum="4" description="OTHER_FINANCIAL_BONDS" />
  <value enum="5" description="CORPORATE_BONDS" />
  <value enum="6" description="CENTRAL_BANK_NOTES" />
  <value enum="7" description="INTERNATIONAL_DEVELOPMENT_INSTITUTION_BONDS"
/>
  <value enum="8" description="MIXED_CAPITAL_BONDS" />
  <value enum="9" description="ASSET_BACKED_SECURITIES" />
  <value enum="10" description="MEDIUM_TERM_NOTES" />
  <value enum="11" description="MUNICIPAL_BONDS" />
  <value enum="12" description="FINANCE_COMPANY_BONDS" />
  <value enum="13" description="SECURITIES_COMPANY_BONDS" />
  <value enum="14" description="SECURITIES_COMPANY_SHORT_TERM_BOND" />
  <value enum="15" description="SHORT_TERM_TREASURY_BONDS" />
  <value enum="16" description="MEDIUM_TERM_TREASURY_BONDS" />
  <value enum="17" description="LONG_TERM_TREASURY_BONDS" />
  <value enum="18" description="COMPOSITIVE_BONDS" />

```



```

    <value enum="19" description="SHORT_TERM_COMMERICAL_PAPER" />
    <value enum="20" description="CRM" />
    <value enum="21" description="DIRECTIONAL_TOOL" />
    <value enum="22" description="GOVERNMENT_BACKED_AGENCY_SECURITIES" />
    <value enum="23" description="AGGREGATIVE_COMMECIAL_PAPERS" />
    <value enum="24" description="COMPANY_BONDS" />
    <value enum="25" description="FINANCIAL_PRODUCTS" />
    <value enum="26" description="NON_BANK_AGENCY_FINANCIAL_BONDS" />
    <value enum="99" description="OTHER" />
    <value enum="27" description="FINANCIAL_LEASING_COMPANY_FINANCIAL_BONDS"
  />
  <value enum="28" description="AUTO_FINANCE_COMPANY_FINANCIAL_BONDS" />
  <value enum="29" description="INTERNATIONAL_DEVELOPMENT_AGENCY_SECURITIES"
  />
  <value enum="30" description="NON_PUBLIC_DIRECTIONAL_DEBT_FINANCING_TOOL"
  />
  <value enum="31" description="FXOPTION" />
</field>
<field number="168" name="EffectiveTime" description="Effective Time"
type="UTCTIMESTAMP" />
  <field number="188" name="BidSpotRate" description="Bid F/X spot rate."
type="PRICE" />
  <field number="189" name="BidForwardPoints" description="Bid F/X forward
points added to spot rate. May be a negative value." type="PRICEOFFSET" />
  <field number="190" name="OfferSpotRate" description="Offer F/X spot rate"
type="PRICE" />
  <field number="191" name="OfferForwardPoints" description="Offer F/X forward
points added to spot rate. May be a negative value." type="PRICEOFFSET" />
  <field number="193" name="SettlDate2" description="2nd settlement date"
type="UTCDATEONLY" />
  <field number="194" name="LastSpotRate" description="Last Spot Rate"
type="FLOAT" />
  <field number="195" name="LastForwardPoints" description="Last Forward
Points" type="FLOAT" />
  <field number="201" name="PutOrCall" description="Put/ call Bond Indicator"
type="CHAR">
    <value enum="0" description="PUT" />
    <value enum="1" description="CALL" />
    <value enum="2" description="CONVERTIBLE" />
    <value enum="3" description="PUT_AND_CALL" />
    <value enum="8" description="OTHER" />
    <value enum="9" description="NONE" />
  </field>

```



```

<field number="202" name="StrikePrice" description="Strike Price for an
Option" type="PRICE" />
<field number="210" name="MaxShow" description="Maximum quantity (e.g. number
of shares) within an order to be shown to other customers" type="QTY" />
<field number="212" name="XmlDataLen" description="Length of the XmlData data
block." type="LENGTH" />
<field number="215" name="NoRoutingIDs" description="Number of repeating
groups of RoutingID (27) and RoutingType (26) values." type="NUMINGROUP" />
<field number="216" name="RoutingType" description="Routing Type" type="INT">
<value enum="1" description="TARGETFIRM" />
<value enum="2" description="TARGETLIST" />
<value enum="5" description="ALL" />
</field>
<field number="217" name="RoutingID" description="Routing ID &#xA;Assigned
value used to identify a specific routing destination." type="STRING" />
<field number="218" name="Spread" description="Spread &#xA;Basis points
relative to a benchmark." type="PRICEOFFSET" />
<field number="220" name="BenchmarkCurveCurrency" description="Benchmark
Currency &#xA;Identifies currency used for benchmark curve." type="CURRENCY" />
<field number="221" name="BenchmarkCurveName" description="Benchmark Name"
type="STRING" />
<field number="222" name="BenchmarkCurvePoint" description="Point on
benchmark curve." type="STRING" />
<field number="223" name="CouponRate" description="Coupon Rate&#xA;For Fixed
Income" type="PERCENTAGE" />
<field number="224" name="CouponPaymentDate" description="Coupon Payment Date
&#xA;Date interest is to be paid. Used in identifying Corporate Bond issues."
type="UTCDATEONLY" />
<field number="225" name="IssueDate" description="Issue Date&#xA;Date
instrument was issued. For Fixed Income IOIs for new issues, specifies the issue
date." type="UTCDATEONLY" />
<field number="232" name="NoStipulations" description="Number of stipulation
entries" type="NUMINGROUP" />
<field number="233" name="StipulationType" description="Stipulation Type
Haircut -Conversion Proportion (s) (%) Yield - Yield/ 1st Leg Yield Yield2 - 2nd
Leg Yield StopYield-STOPYIELD Discount-discount rate;StrikeYield - Strike
Yield;StopStrikeYield-Stop Strike Yield" type="STRING">
<value enum="Haircut" description="CONVERSION_PROPORTION" />
<value enum="Yield" description="YIELD_OR_1ST_LEG_YIELD" />
<value enum="Yield2" description="SECOND_LEG_YIELD" />
<value enum="StopYield" description="STOPYIELD" />
<value enum="Discount" description="DISCOUNT_RATE" />
<value enum="StrikeYield" description="STRIKE_YIELD" />

```

```

    <value enum="StopStrikeYield" description="STOP_STRIKE_YIELD" />
    <value enum="ReissueYield" description="REISUE_YIELD" />
    <value enum="PortfolioYield" description="PORTFOLIO_YIELD" />
</field>
<field number="234" name="StipulationValue" description="Value of
stipulation&#xA;For Fixed Income." type="STRING" />
<field number="235" name="YieldType" description="Yield Type " type="STRING">
    <value enum="MATURITY" description="YIELD_TO_MATURITY" />
    <value enum="ATISSUE" description="YIELD_AT_ISSUE" />
</field>
<field number="236" name="Yield" description="Yield" type="PERCENTAGE" />
<field number="241" name="UnderlyingCouponPaymentDate"
description="Underlying Security's Coupon Payment Date" type="UTCDATEONLY" />
<field number="242" name="UnderlyingIssueDate" description="Underlying Issue
Date&#xA;Date instrument was issued. For Fixed Income IOIs for new issues, specifies
the issue date." type="UTCDATEONLY" />
<field number="248" name="LegCouponPaymentDate" description="First regular
payment date" type="UTCDATEONLY" />
<field number="249" name="LegIssueDate" description="Date instrument was
issued." type="UTCDATEONLY" />
<field number="255" name="CreditRating" description="Credit
Rating&#xD;&#xA;An evaluation of a company's ability to repay obligations or its
likelihood of not defaulting." type="STRING" />
<field number="256" name="UnderlyingCreditRating" description="Underlying
Credit Rating&#xA;An evaluation of a company's ability to repay obligations or
its likelihood of not defaulting." type="STRING" />
<field number="262" name="MDReqID" description="" type="STRING" />
<field number="263" name="SubscriptionRequestType" description=""
type="CHAR">
    <value enum="3" description="BROADCAST_REQUEST" />
    <value enum="4" description="PRICE_DATA_FULL_IMAGE_REFRESH_REQUEST" />
    <value enum="5" description="HISTORICAL_DATA_RETRANSMISSION_REQUEST" />
    <value enum="6" description="DEAL_INFO" />
    <value enum="7" description="MARKET_DATA" />
    <value enum="8" description="QUOTE_INFO" />
</field>
<field number="267" name="NoMDEntryTypes" description="" type="NUMINGROUP" />
<field number="268" name="NoMDEntries" description="" type="NUMINGROUP" />
<field number="269" name="MDEntryType" description="" type="CHAR">
    <value enum="0" description="LAST_DEALT_RATE" />
    <value enum="1" description="BEST_RATE" />
    <value enum="2" description="LAST_ALL_IN_DEALT_RATE" />
    <value enum="3" description="INDEX_VALUE_OR_BENCHMARK_VALUE" />

```

```

<value enum="4" description="OPENING_PRICE" />
<value enum="5" description="CLOSING_PRICE" />
<value enum="7" description="TRADING_SESSION_HIGH_DEALT_PRICE" />
<value enum="8" description="TRADING_SESSION_LOW_DEALT_PRICE" />
<value enum="9" description="NEAR_LEG_HIGH" />
<value enum="A" description="FAR_LEG_HIGH" />
<value enum="B" description="TRADE_VOLUME" />
<value enum="C" description="NEAR_LEG_LOW" />
<value enum="D" description="FAR_LEG_LOW" />
<value enum="E" description="NEAR_LEG_OPEN" />
<value enum="F" description="FAR_LEG_OPEN" />
<value enum="G" description="NEAR_LEG_LAST" />
<value enum="H" description="MID_PRICE_OR_CENTRAL_PARITY_RATE" />
<value enum="I" description="FAR_LEG_LAST" />
<value enum="a" description="CHANGE_OVER" />
<value enum="b" description="TRADE_AMOUT" />
<value enum="c" description="TRADING_BANK_UPPER_LIMIT" />
<value enum="d" description="TRADING_BANK_LOWER_LIMIT" />
<value enum="e" description="LATEST_PRICE" />
<value enum="f" description="PREVIOUS_CLOSING_PRICE" />
<value enum="g" description="WEIGHTED_AVERAGE_PRICE" />
<value enum="h" description="PREVIOUS_WEIGHTED_AVERAGE_PRICE" />
<value enum="i" description="PREVIOUS_CLOSING_YIELD" />
<value enum="j" description="PREVIOUS_WEIGHTED_AVERAGE_YIELD" />
<value enum="k" description="OPEN_YIELD" />
<value enum="l" description="LAST_YIELD" />
<value enum="m" description="HIGHEST_YIELD" />
<value enum="n" description="LOWEST_YIELD" />
<value enum="o" description="CLOSING_YIELD" />
<value enum="p" description="WEIGHTED_AVERAGE_YIELD" />
<value enum="q" description="PREVIOUS_CLOSING_SPREAD" />
<value enum="r" description="PREVIOUS_WEIGHTED_AVERAGE_SPREAD" />
<value enum="s" description="OPEN_SPREAD" />
<value enum="t" description="LAST_SPREAD" />
<value enum="u" description="LOWEST_SPREAD" />
<value enum="v" description="HIGHEST_SPREAD" />
<value enum="w" description="CLOSING_SPREAD" />
<value enum="x" description="WEIGHTED_AVERAGE_SPREAD" />
<value enum="Z" description="SETTLEMENT_DATE" />
<value enum="y" description="BEST_ALL_IN_PRICE" />
</field>
<field number="270" name="MDEntryPx" description="" type="PRICE" />
<field number="271" name="MDEntrySize" description="Quantity or volume

```

```

represented by the Market Data Entry" type="QTY" />
  <field number="272" name="MDEntryDate" description="Market Data Updated Date"
type="UTCDATEONLY" />
  <field number="273" name="MDEntryTime" description="Market Data Updated Time"
type="UTCTIMEONLY" />
  <field number="295" name="NoQuoteEntries" description="The number of quote
entries for a QuoteSet" type="NUMINGROUP" />
  <field number="296" name="NoQuoteSets" description="The number of quote
entries for a QuoteSet" type="NUMINGROUP" />
  <field number="297" name="QuoteStatus" description="Quote Status" type="INT">
    <value enum="5" description="REJECTED" />
    <value enum="16" description="NORMAL" />
    <value enum="17" description="RECEIVED" />
    <value enum="18" description="SENT" />
    <value enum="19" description="CANCELLED" />
    <value enum="20" description="CONTINGENCY" />
    <value enum="21" description="EXPIRED" />
    <value enum="101" description="CANCELLED_DUE_TO_ASSET_SUSPENSION" />
    <value enum="102" description="CANCELLED_DUE_TO_PRODUCT_SUSPENSION" />
    <value enum="103" description="CANCELLED_DUE_TO_USER_SUSPENSION" />
    <value enum="104" description="CANCELLED_DUE_TO_ENTITY_SUSPENSION" />
    <value enum="105" description="CANCELLED_DUE_TO_FILLED" />
    <value enum="106" description="CANCELLED_DUE_TO_PARTIALLY_FILLED" />
    <value enum="107" description="FILLED" />
    <value enum="108" description="PARTIALLY_FILLED" />
    <value enum="109" description="CANCELLED_DUE_TO_TRADE_METHOD_SUSPENSION"
/>
  <value enum="110" description="CANCELLED_BY_SYSTEM" />
  <value enum="111"
description="CANCELLED_DUE_TO_AMOUNT_LESS_THAN_MINIMUM_AMOUNT" />
  <value enum="112"
description="MODIFIED_DUE_TO_ACCOUNT_INFORMATION_CHANGED" />
  <value enum="113" description="INVALID" />
</field>
  <field number="299" name="QuoteEntryID" description="Uniquely identifies the
quote as part of a QuoteSet.&#xA;Must be used if NoQuoteEntries is used"
type="STRING" />
  <field number="302" name="QuoteSetID" description="Unique id for the Quote
Set." type="STRING" />
  <field number="305" name="UnderlyingSecurityIDSource"
description="Underlying Security ID Source&#xA;Required if SecurityID is
specified." type="STRING">
    <value enum="5" description="RIC_CODE" />

```

```

    <value enum="101" description="CFETS" />
    <value enum="102" description="CDC" />
    <value enum="103" description="USERDEFINED" />
  </field>
  <field number="306" name="UnderlyingIssuer" description="Underlying
instrument Issuer" type="STRING" />
    <field number="307" name="UnderlyingSecurityDesc" description="Underlying
Instrument Description" type="STRING" />
    <field number="309" name="UnderlyingSecurityID" description="Underlying
Security Code" type="STRING" />
    <field number="310" name="UnderlyingSecurityType" description="Underlying
Security Type" type="STRING">
      <value enum="0" description="TREASURY_BONDS" />
      <value enum="1" description="POLICY_FINANCIAL_BONDS" />
      <value enum="2" description="COMMERCIAL_PAPERS" />
      <value enum="3" description="SUBORDINATED_BONDS" />
      <value enum="4" description="OTHER_FINANCIAL_BONDS" />
      <value enum="5" description="CORPORATE_BONDS" />
      <value enum="6" description="CENTRAL_BANK_NOTES" />
      <value enum="7" description="INTERNATIONAL_DEVELOPMENT_INSTITUTION_BONDS"
/>
      <value enum="8" description="MIXED_CAPITAL_BONDS" />
      <value enum="9" description="ASSET_BACKED_SECURITIES" />
      <value enum="10" description="MEDIUM_TERM_NOTES" />
      <value enum="11" description="MUNICIPAL_BONDS" />
      <value enum="12" description="FINANCE_COMPANY_BONDS" />
      <value enum="13" description="SECURITIES_COMPANY_BONDS" />
      <value enum="14" description="SECURITIES_COMPANY_SHORT_TERM_BOND" />
      <value enum="15" description="SHORT_TERM_TREASURY_BONDS" />
      <value enum="16" description="MEDIUM_TERM_TREASURY_BONDS" />
      <value enum="17" description="LONG_TERM_TREASURY_BONDS" />
      <value enum="18" description="COMPOSITIVE_BONDS" />
      <value enum="19" description="SHORT_TERM_COMMERICAL_PAPER" />
      <value enum="20" description="CRM" />
    </field>
  <field number="311" name="UnderlyingSymbol" description="Underlying
Instrument Name" type="STRING" />
    <field number="318" name="UnderlyingCurrency" description="Underlying
Currency&#xA;Identifies currency used for trading. Absence of this field is
interpreted as the default for the security. The default is CNY" type="CURRENCY"
/>
    <field number="320" name="SecurityReqID" description="Security List Request
ID" type="STRING" />

```

```

    <field number="322" name="SecurityResponseID" description="" type="STRING" />
    <field number="335" name="TradSesReqID" description="Unique ID of a Trading
Session Status message" type="STRING" />
    <field number="336" name="TradingSessionID" description="Trading Session
Identifier" type="STRING" />
    <field number="340" name="TradSesStatus" description="State of the trading
session." type="INT">
        <value enum="0" description="UNKNOWN" />
        <value enum="1" description="HALTED" />
        <value enum="2" description="OPENING" />
        <value enum="3" description="CLOSING" />
        <value enum="4" description="PRE_OPEN" />
        <value enum="5" description="PRE_CLOSE" />
        <value enum="6" description="REQUEST_REJECTED" />
        <value enum="7" description="LUNCH_BREAK" />
        <value enum="8" description="POST_LUNCH" />
        <value enum="9" description="POST_CLOSING" />
        <value enum="10" description="PRE_LUNCH" />
        <value enum="11" description="EOD" />
    </field>
    <field number="341" name="TradSesStartTime" description="TradSesStartTime"
type="UTCTIMESTAMP" />
    <field number="342" name="TradSesOpenTime" description="TradSesOpenTime"
type="UTCTIMESTAMP" />
    <field number="343" name="TradSesPreCloseTime"
description="TradSesPreCloseTime" type="UTCTIMESTAMP" />
    <field number="344" name="TradSesCloseTime" description="TradSesCloseTime"
type="UTCTIMESTAMP" />
    <field number="345" name="TradSesEndTime" description="TradSesEndTime"
type="UTCTIMESTAMP" />
    <field number="347" name="MessageEncoding" description="Message
Encoding&#xA;Type of message encoding (non-ASCII (non-English) characters) used
in a messages &quot;Encoded&quot; fields" type="STRING" />
    <field number="354" name="EncodedTextLen" description="Encoded Text Length
&#xA;Byte length of encoded (non-ASCII characters) EncodedText (355) field."
type="LENGTH" />
    <field number="355" name="EncodedText" description="Encoded Text&#xA;Encoded
(non-ASCII characters) representation of the Text (58) field in the encoded format
specified via the MessageEncoding (347) field. If used, the ASCII (English)
representation should also be specified in the Text field." type="DATA" />
    <field number="369" name="LastMsgSeqNumProcessed" description="The last
MsgSeqNum (34) value received by the FIX engine and processed by downstream
application, such as trading engine or order routing system. Can be specified on

```

every message sent. Useful for detecting a backlog with a counterparty."

```

type="SEQNUM" />
  <field number="371" name="RefTagID" description="Reference Tag Number &#xA;The
tag number of the FIX field being referenced" type="INT" />
  <field number="372" name="RefMsgType" description="Reference Message Type The
MsgType (35) of the FIX message being referenced" type="STRING" />
  <field number="373" name="SessionRejectReason" description="Session Reject
Reason&#xA;0 = Invalid tag number&#xA;1 = Required tag missing&#xA;2 = Tag not
defined for this message type&#xA;3 = Undefined Tag&#xA;4 = Tag specified without
a value&#xA;5 = Value is incorrect (out of range) for this tag&#xA;6 = Incorrect
data format for value&#xA;7 = Decryption problem&#xA;8 = Signature problem &#xA;9
= CompID problem&#xA;10 = SendingTime accuracy problem &#xA;11 = Invalid MsgType
&#xA;12 = XML Validation error&#xA;13 = Tag appears more than once&#xA;14 = Tag
specified out of required order&#xA;15 = Repeating group fields out of order&#xA;16
= Incorrect NumInGroup count for repeating group&#xA;17 = Non
&quot;data&quot; value includes field delimiter (SOH character)"
type="INT">
  <value enum="0" description="INVALID_TAG_NUMBER" />
  <value enum="1" description="REQUIRED_TAG_MISSING" />
  <value enum="2" description="TAG_NOT_DEFINED_FOR_THIS_MESSAGE_TYPE" />
  <value enum="3" description="UNDEFINED_TAG" />
  <value enum="4" description="TAG_SPECIFIED_WITHOUT_A_VALUE" />
  <value enum="5" description="VALUE_IS_INCORRECT" />
  <value enum="6" description="INCORRECT_DATA_FORMAT_FOR_VALUE" />
  <value enum="7" description="DECRYPTION_PROBLEM" />
  <value enum="8" description="SIGNATURE_PROBLEM" />
  <value enum="9" description="COMPID_PROBLEM" />
  <value enum="10" description="SENDINGTIME_ACCURACY_PROBLEM" />
  <value enum="11" description="INVALID_MSGTYPE" />
  <value enum="12" description="XML_VALIDATION_ERROR" />
  <value enum="13" description="TAG_APPEARS_MORE_THAN_ONCE" />
  <value enum="14" description="TAG_SPECIFIED_OUT_OF_REQUIRED_ORDER" />
  <value enum="15" description="REPEATING_GROUP_FIELDS_OUT_OF_ORDER" />
  <value enum="16"
description="INCORRECT_NUMINGROUP_COUNT_FOR_REPEATING_GROUP" />
  <value enum="17" description="NON_DATA_VALUE_INCLUDES_FIELD_DELIMITER" />
</field>
  <field number="379" name="BusinessRejectRefID" description="The value of the
business level 'ID' field on the message being referenced." type="STRING" />
  <field number="380" name="BusinessRejectReason" description="Code to identify
reason for a Business Message Reject message.; Valid values:; 0 - Other; 1 - Unkown
ID; 2 - Unknown Security; 3 - Unsupported Message Type; 4 - Application not available;
5 - Conditionally Required Field Missing; 6 - Not authorized; 7 - DeliverTo firm

```



```

not available at this time; 8-Security in Shut Period" type="INT">
  <value enum="0" description="OTHER" />
  <value enum="1" description="UNKOWN_ID" />
  <value enum="2" description="UNKNOWN_SECURITY" />
  <value enum="3" description="UNSUPPORTED_MESSAGE_TYPE" />
  <value enum="4" description="APPLICATION_NOT_AVAILABLE" />
  <value enum="5" description="CONDITIONALLY_REQUIRED_FIELD_MISSING" />
  <value enum="6" description="NOT_AUTHORIZED" />
  <value enum="7" description="DELIVERTO_FIRM_NOT_AVAILABLE_AT_THIS_TIME" />
  <value enum="8" description="SECURITY_IN_SHUT_PERIOD" />
</field>
<field number="383" name="MaxMessageSize" description="Number of MsgTypes (35)
in repeating group." type="LENGTH" />
  <field number="393" name="TotNoRelatedSym" description="" type="INT" />
  <field number="423" name="PriceType" description="Price Type &#xA;1 -
Percentage;&#xA;2 - Per unit;&#xA;3 - Fixed amount;&#xA;4 - Discount;&#xA;5 -
Premium;&#xA;6 - Spread" type="INT">
    <value enum="1" description="PERCENTAGE" />
    <value enum="2" description="PER_UNIT" />
    <value enum="3" description="FIXED_AMOUNT" />
    <value enum="4" description="DISCOUNT" />
    <value enum="5" description="PREMIUM" />
    <value enum="6" description="SPREAD" />
  </field>
  <field number="430" name="NetGrossInd" description="Code to represent whether
value is net (inclusive of tax) or gross." type="INT">
    <value enum="1" description="NET_NEGOTIATION" />
    <value enum="2" description="GROSS" />
    <value enum="3" description="NET_MATCH" />
  </field>
  <field number="432" name="ExpireDate" description="Quote Expire Date"
type="UTCDATEONLY" />
  <field number="435" name="UnderlyingCouponRate" description="Underlying
Coupon Rate&#xA;For Fixed Income." type="PERCENTAGE" />
  <field number="443" name="StrikeTime" description="" type="UTCTIMESTAMP" />
  <field number="447" name="PartyIDSource" description="Party ID Source"
type="STRING">
    <value enum="B" description="BIC" />
    <value enum="101" description="BANK_SORT_CODE" />
    <value enum="102" description="CFETS_PARTY_COE" />
  </field>
  <field number="448" name="PartyID" description="Group party identifier"
type="STRING" />

```



```

<field number="452" name="PartyRole" description="The role of participant
party" type="INT">
  <value enum="101" description="INITIATOR" />
  <value enum="102" description="COUNTERPARTY" />
  <value enum="103" description="CLEARING_MEMBER" />
  <value enum="104" description="CLEARING_BANK" />
  <value enum="105" description="CUSTODIAN_INSTITUTION" />
  <value enum="106" description="CUSTODIAN_BANK" />
  <value enum="107" description="SETTLEMENT_AGENT" />
  <value enum="108" description="MARGIN_MANAGEMENT_INSTITUTION" />
  <value enum="109" description="MARGIN_CUSTODIAN_INSTITUTION" />
  <value enum="110" description="MARGIN_AGENT" />
  <value enum="111" description="CONTINGENCY_PARTY" />
  <value enum="112" description="SUPPLEMENTARY_PARTY" />
  <value enum="113" description="MARKET_MAKER" />
  <value enum="114" description="MARKET_TAKER" />
  <value enum="115" description="FUND_MANAGEMENT_COMPANY" />
  <value enum="116" description="INFORMER" />
  <value enum="117" description="CONTRACT_BREAKER" />
  <value enum="118" description="SHIBOR_QUOTE_PARTY" />
  <value enum="119"
description="BUYER_OR_BORROWER_OR_REVERSE_REPOER_OR_FIXED_PAYER_OR_BENCHMARK_
1_PAYER" />
  <value enum="120"
description="SELLER_OR_LENDER_OR_REPOER_OR_FIXED_RECEIVER_OR_BENCHMARK_1_RECE
IVER" />
  <value enum="121" description="ACTION_INITIATOR" />
  <value enum="122" description="ACTION_COUNTERPARTY" />
  <value enum="123" description="MARKET_TAKER_FOR_CNY" />
  <value enum="124" description="MARKET_TAKER_FOR_FX" />
  <value enum="125" description="CFETS_MEMBER" />
  <value enum="126" description="PAYMENT_BANK" />
  <value enum="127" description="BID_LPS" />
  <value enum="128" description="ASK_LPS" />
</field>
<field number="453" name="NoPartyIDs" description="Number of parties. If have
GroupGrp, Parties will be defined in GroupGrp" type="NUMINGROUP" />
<field number="454" name="NoSecurityAltID" description="" type="NUMINGROUP"
/>
<field number="455" name="SecurityAltID" description="" type="STRING" />
<field number="456" name="SecurityAltIDSource" description="" type="STRING">
  <value enum="0" description="CFETS" />
  <value enum="4" description="ISIN" />

```

```

</field>
<field number="464" name="TestMessageIndicator" description="Indicates
whether or not this FIX Session is a 'test' vs. 'production' connection. Useful
for preventing 'accidents'.; Valid values:; Y - True (Test); N - False
(Production)" type="BOOLEAN">
  <value enum="Y" description="TRUE" />
  <value enum="N" description="FALSE" />
</field>
<field number="470" name="CountryOfIssue" description="ISO Country code of
instrument issue (e.g. the country portion typically used in ISIN). Can be used
in conjunction with non-ISIN SecurityID (48) (e.g. CUSIP for Municipal Bonds without
ISIN) to provide uniqueness." type="COUNTRY" />
<field number="487" name="TradeReportTransType" description="" type="INT">
  <value enum="0" description="NEW" />
  <value enum="1" description="CANCEL" />
  <value enum="2" description="REPLACE" />
</field>
<field number="504" name="PaymentDate" description="Payment Date"
type="UTCDATEONLY" />
<field number="518" name="NoContAmts" description="" type="NUMINGROUP" />
<field number="519" name="ContAmtType" description="" type="INT">
  <value enum="1" description="COMMISSION_AMOUNT_ACTUAL" />
  <value enum="2" description="COMMISSION_PERCENT_ACTUAL" />
  <value enum="3" description="INITIAL_CHARGE_AMOUNT" />
  <value enum="4" description="INITIAL_CHARGE_PERCENT" />
  <value enum="5" description="DISCOUNT_AMOUNT" />
  <value enum="6" description="DISCOUNT_PERCENT" />
  <value enum="7" description="DILUTION_LEVY_AMOUNT" />
  <value enum="8" description="DILUTION_LEVY_PERCENT" />
  <value enum="9" description="EXIT_CHARGE_AMOUNT" />
  <value enum="10" description="EXIT_CHARGE_PERCENT" />
  <value enum="11"
description="FUND_BASED_RENEWAL_COMMISSION_PERCENT_TRAIL_COMMISSION" />
  <value enum="12"
description="PROJECTED_FUND_VALUE_FOR_INVESTMENTS_INTENDED_TO_REALISE_OR_EXCE
ED_A_SPECIFIC_FUTURE_VALUE" />
  <value enum="13"
description="FUND_BASED_RENEWAL_COMMISSION_AMOUNT_BASED_ON_ORDER_VALUE" />
  <value enum="14"
description="FUND_BASED_RENEWAL_COMMISSION_AMOUNT_BASED_ON_PROJECTED_FUND_VAL
UE" />
  <value enum="15" description="NET_SETTLEMENT_AMOUNT" />
</field>

```

```

<field number="520" name="ContAmtValue" description="" type="AMT" />
<field number="523" name="PartySubID" description="Sub-identifier"
type="STRING" />
<field number="537" name="QuoteType" description="Quote Type" type="INT">
  <value enum="0" description="INDICATIVE" />
  <value enum="1" description="TRADEABLE" />
  <value enum="3" description="COUNTER" />
  <value enum="4" description="ALL" />
  <value enum="101" description="TWO_WAY" />
  <value enum="102" description="PRICE_LIMIT_ORDER" />
  <value enum="103" description="CLICK_AND_NEGOTIATE_QUOTE" />
  <value enum="104" description="ORDER" />
  <value enum="105" description="CLICK_AND_DEAL_QUOTE" />
  <value enum="106" description="SUPPLEMENTARY_CLAUSE" />
  <value enum="107" description="MARKET_MAKING" />
  <value enum="110"
description="DYNAMIC_VALUATION_DATA_OF_BENCHMARK_SECURITY" />
  <value enum="111"
description="CLOSING_VALUATION_DATA_OF_BENCHMARK_SECURITY" />
</field>
<field number="541" name="MaturityDate" description="Maturity
Date&#xA;Specifies date of maturity (a full date). Note that standardized
derivatives which are typically only referenced by month and year (e.g. S&amp;P
futures).may use MaturityMonthYear and/or this field. When using MaturityMonthYear,
it is recommended that markets and sell sides report the MaturityDate on all outbound
messages as a means of data enrichment." type="UTCDATEONLY" />
  <field number="542" name="UnderlyingMaturityDate" description="Maturity
Date&#xA;Specifies date of maturity (a full date)." type="UTCDATEONLY" />
  <field number="552" name="NoSides" description="Number of Side repeating group
instances. ; Valid values:; 1 - one side; 2 - both sides" type="NUMINGROUP">
    <value enum="1" description="ONE_SIDE" />
    <value enum="2" description="BOTH_SIDES" />
  </field>
  <field number="553" name="Username" description="Userid or username."
type="STRING" />
  <field number="554" name="Password" description="Password" type="STRING" />
  <field number="555" name="NoLegs" description="Number of repeating group
instances." type="NUMINGROUP" />
  <field number="556" name="LegCurrency" description="Currency"
type="CURRENCY" />
  <field number="559" name="SecurityListRequestType" description=""
type="INT">
    <value enum="4" description="ALL_COLLATERAL_SECURITIES" />

```

```

    <value enum="101" description="SPECIFIC_COLLATERAL_SECURITY_DEFINED" />
    <value enum="102"
description="ALL_COLLATERAL_SECURITIES_DEFINED_IN_SPECIFIC_DATE" />
  </field>
  <field number="562" name="MinTradeVol" description="" type="QTY" />
  <field number="566" name="LegPrice" description="Price for leg of a multileg"
type="PRICE" />
  <field number="571" name="TradeReportID" description="Unique identifier of
trade capture report" type="STRING" />
  <field number="587" name="LegSettlType" description="Refer to values for
SettlType [63]" type="STRING">
    <value enum="0" description="REGULAR" />
    <value enum="1" description="CASH_OR_TOD_OR_T_PLUS_0" />
    <value enum="2" description="NEXT_DAY_OR_TOM_OR_T_PLUS_1" />
    <value enum="3" description="T_PLUS_2" />
    <value enum="4" description="T_PLUS_3" />
    <value enum="5" description="T_PLUS_4" />
    <value enum="6" description="FUTURE" />
    <value enum="7" description="WHEN_AND_IF_ISSUED" />
    <value enum="8" description="SELLERS_OPTION" />
    <value enum="9" description="T_PLUS_5" />
    <value enum="ON" description="LEGSETTLTYPE_VALUE_ON" />
    <value enum="TODAY" description="LEGSETTLTYPE_VALUE_TODAY" />
    <value enum="TN" description="LEGSETTLTYPE_VALUE_TN" />
    <value enum="TOM" description="LEGSETTLTYPE_VALUE_TOM" />
    <value enum="SPOT" description="LEGSETTLTYPE_VALUE_SPOT" />
    <value enum="1D" description="LEGSETTLTYPE_VALUE_1D" />
    <value enum="SN" description="LEGSETTLTYPE_VALUE_SN" />
    <value enum="1W" description="LEGSETTLTYPE_VALUE_1W" />
    <value enum="2W" description="LEGSETTLTYPE_VALUE_2W" />
    <value enum="3W" description="LEGSETTLTYPE_VALUE_3W" />
    <value enum="4W" description="LEGSETTLTYPE_VALUE_4W" />
    <value enum="1M" description="LEGSETTLTYPE_VALUE_1M" />
    <value enum="2M" description="LEGSETTLTYPE_VALUE_2M" />
    <value enum="3M" description="LEGSETTLTYPE_VALUE_3M" />
    <value enum="4M" description="LEGSETTLTYPE_VALUE_4M" />
    <value enum="5M" description="LEGSETTLTYPE_VALUE_5M" />
    <value enum="6M" description="LEGSETTLTYPE_VALUE_6M" />
    <value enum="7M" description="LEGSETTLTYPE_VALUE_7M" />
    <value enum="8M" description="LEGSETTLTYPE_VALUE_8M" />
    <value enum="9M" description="LEGSETTLTYPE_VALUE_9M" />
    <value enum="10M" description="LEGSETTLTYPE_VALUE_10M" />
    <value enum="11M" description="LEGSETTLTYPE_VALUE_11M" />

```

```

<value enum="1Y" description="LEGSETTLTYPE_VALUE_1Y" />
<value enum="18M" description="LEGSETTLTYPE_VALUE_18M" />
<value enum="BROKEN" description="LEGSETTLTYPE_VALUE_BROKEN" />
<value enum="7D" description="LEGSETTLTYPE_VALUE_7D" />
<value enum="2Y" description="LEGSETTLTYPE_VALUE_2Y" />
<value enum="3Y" description="LEGSETTLTYPE_VALUE_3Y" />
<value enum="4Y" description="LEGSETTLTYPE_VALUE_4Y" />
<value enum="5Y" description="LEGSETTLTYPE_VALUE_5Y" />
<value enum="6Y" description="LEGSETTLTYPE_VALUE_6Y" />
<value enum="7Y" description="LEGSETTLTYPE_VALUE_7Y" />
<value enum="8Y" description="LEGSETTLTYPE_VALUE_8Y" />
<value enum="9Y" description="LEGSETTLTYPE_VALUE_9Y" />
<value enum="10Y" description="LEGSETTLTYPE_VALUE_10Y" />
<value enum="11Y" description="LEGSETTLTYPE_VALUE_11Y" />
<value enum="12Y" description="LEGSETTLTYPE_VALUE_12Y" />
<value enum="13Y" description="LEGSETTLTYPE_VALUE_13Y" />
<value enum="14Y" description="LEGSETTLTYPE_VALUE_14Y" />
<value enum="15Y" description="LEGSETTLTYPE_VALUE_15Y" />
<value enum="16Y" description="LEGSETTLTYPE_VALUE_16Y" />
<value enum="17Y" description="LEGSETTLTYPE_VALUE_17Y" />
<value enum="18Y" description="LEGSETTLTYPE_VALUE_18Y" />
<value enum="19Y" description="LEGSETTLTYPE_VALUE_19Y" />
<value enum="20Y" description="LEGSETTLTYPE_VALUE_20Y" />
<value enum="21Y" description="LEGSETTLTYPE_VALUE_21Y" />
<value enum="22Y" description="LEGSETTLTYPE_VALUE_22Y" />
<value enum="23Y" description="LEGSETTLTYPE_VALUE_23Y" />
<value enum="24Y" description="LEGSETTLTYPE_VALUE_24Y" />
<value enum="25Y" description="LEGSETTLTYPE_VALUE_25Y" />
<value enum="26Y" description="LEGSETTLTYPE_VALUE_26Y" />
<value enum="27Y" description="LEGSETTLTYPE_VALUE_27Y" />
<value enum="28Y" description="LEGSETTLTYPE_VALUE_28Y" />
<value enum="29Y" description="LEGSETTLTYPE_VALUE_29Y" />
<value enum="30Y" description="LEGSETTLTYPE_VALUE_30Y" />
<value enum="40Y" description="LEGSETTLTYPE_VALUE_40Y" />
<value enum="50Y" description="LEGSETTLTYPE_VALUE_50Y" />
</field>
<field number="588" name="LegSettlDate" description="Refer to description for
SettlDate [64]" type="UTCDATEONLY" />
<field number="600" name="LegSymbol" description="-Trading Product
name&#xA;-Standard product name" type="STRING" />
<field number="602" name="LegSecurityID" description="-Trading Product
&#xA;-Standard product" type="STRING" />
<field number="603" name="LegSecurityIDSource" description="Multileg

```

```

instrument's individual security's SecurityIDSource ." type="STRING">
  <value enum="5" description="RIC_CODE" />
  <value enum="101" description="CFETS" />
  <value enum="102" description="CDC" />
  <value enum="103" description="USERDEFINED" />
</field>
<field number="609" name="LegSecurityType" description="Refer to definition
of SecurityType(167)" type="STRING">
  <value enum="0" description="TREASURY_BONDS" />
  <value enum="1" description="POLICY_FINANCIAL_BONDS" />
  <value enum="2" description="COMMERCIAL_PAPERS" />
  <value enum="3" description="SUBORDINATED_BONDS" />
  <value enum="4" description="OTHER_FINANCIAL_BONDS" />
  <value enum="5" description="CORPORATE_BONDS" />
  <value enum="6" description="CENTRAL_BANK_NOTES" />
  <value enum="7" description="INTERNATIONAL_DEVELOPMENT_INSTITUTION_BONDS"
/>
  <value enum="8" description="MIXED_CAPITAL_BONDS" />
  <value enum="9" description="ASSET_BACKED_SECURITIES" />
  <value enum="10" description="MEDIUM_TERM_NOTES" />
  <value enum="11" description="MUNICIPAL_BONDS" />
  <value enum="12" description="FINANCE_COMPANY_BONDS" />
  <value enum="13" description="SECURITIES_COMPANY_BONDS" />
  <value enum="14" description="SECURITIES_COMPANY_SHORT_TERM_BOND" />
  <value enum="15" description="SHORT_TERM_TREASURY_BONDS" />
  <value enum="16" description="MEDIUM_TERM_TREASURY_BONDS" />
  <value enum="17" description="LONG_TERM_TREASURY_BONDS" />
  <value enum="18" description="COMPOSITIVE_BONDS" />
  <value enum="19" description="SHORT_TERM_COMMERICAL_PAPER" />
  <value enum="20" description="CRM" />
  <value enum="21" description="DIRECTIONAL_TOOL" />
</field>
<field number="610" name="LegMaturityMonthYear" description="Multileg
instrument's individual security's MaturityMonthYear ." type="MONTH-YEAR" />
  <field number="611" name="LegMaturityDate" description="Multileg
instrument's individual security's MaturityDate ." type="UTCDATEONLY" />
  <field number="615" name="LegCouponRate" description="Multileg instrument's
individual security's CouponRate ." type="PERCENTAGE" />
  <field number="617" name="LegIssuer" description="Multileg instrument's
individual security's Issuer ." type="STRING" />
  <field number="624" name="LegSide" description="" type="CHAR">
    <value enum="1" description="BUY_FIXED_PAY_BENCHMARK_PAY_IN_RMB_MARKET" />
    <value enum="4"

```

```

description="SELL_FIXED_RECEIVE_BENCHMARK_RECEIVE_IN_RMB_MARKET" />
  <value enum="B" description="BASE_LEG_FOR_TWO_WAY_QUOTE_IN_RMB_IRS_OR_FRA"
/>
  <value enum="1"
description="FIXED_RECEIVER_BENCHMARK_RECEIVER_TAKER_RECEIVE" />
  <value enum="4" description="FIXED_PAYER_BENCHMARK_PAYER_TAKER_PAY" />
</field>
  <field number="627" name="NoHops" description="Number of HopCompID entries in
repeating group." type="NUMINGROUP" />
  <field number="628" name="HopCompID" description="Assigned value used to
identify the third party firm which delivered a specific message either from the
firm which originated the message or from another third party (if multiple 'hops'
are performed). It is recommended that this value be the SenderCompID (49) of the
third party.Applicable when messages are communicated or re-distributed via third
parties which function as service bureaus or 'hubs'. Only applicable if
OnBehalfOfCompID (115) is being used." type="STRING" />
  <field number="629" name="HopSendingTime" description="Time that HopCompID
(628) sent the message. It is recommended that this value be the SendingTime (52)
of the message sent by the third party.Applicable when messages are
communicated/re-distributed via third parties which function as service bureaus
or 'hubs'. Only applicable if OnBehalfOfCompID (115) is being used."
type="UTCTIMESTAMP" />
  <field number="630" name="HopRefID" description="Reference identifier
assigned by HopCompID (628) associated with the message sent. It is recommended
that this value be the MsgSeqNum (34) of the message sent by the third
party.;Applicable when messages are communicated/re-distributed via third parties
which function as service bureaus or 'hubs'. Only applicable if OnBehalfOfCompID
(115) is being used." type="SEQNUM" />
  <field number="637" name="LegLastPx" description=" (FX Market: Leg All In Rate)
" type="PRICE" />
  <field number="649" name="QuoteStatusReqID" description="The unique ID of
Quote Status Request message." type="STRING" />
  <field number="658" name="QuoteRequestRejectReason" description="Reason
Quote was rejected" type="INT">
    <value enum="101" description="COUNTERPART_ERROR" />
    <value enum="102" description="CREDIT_ERROR" />
    <value enum="103" description="DEAL_DATA_ERROR" />
    <value enum="104" description="INTERNAL_ERROR" />
    <value enum="105" description="UNKNOWN_DEAL_ERROR" />
    <value enum="106" description="USER_DATA_ERROR" />
  </field>
  <field number="662" name="BenchmarkPrice" description="Specifies the price of
the benchmark." type="PRICE" />

```



```

    <field number="663" name="BenchmarkPriceType" description="Identifies type of
BenchmarkPrice (662). &#xA;&#xA;See PriceType (423) for valid values."
type="INT" />
    <field number="664" name="ConfirmID" description="" type="STRING" />
    <field number="665" name="ConfirmStatus" description="Identifies the status
of the Confirmation" type="INT">
        <value enum="2" description="MISMATCHED_ACCOUNT" />
        <value enum="4" description="CONFIRMED" />
    </field>
    <field number="667" name="ContractSettlMonth" description="Must be present for
MBS/TBA" type="MONTH-YEAR" />
    <field number="668" name="DeliveryForm" description="" type="INT">
        <value enum="0" description="CASH" />
        <value enum="1" description="BOOK_ENTRY" />
        <value enum="2" description="BEARER" />
        <value enum="101" description="OTHER" />
    </field>
    <field number="675" name="LegSettlCurrency" description="FX : Settlement
Currency" type="STRING" />
    <field number="676" name="LegBenchmarkCurveCurrency" description="Identifies
currency used for benchmark curve." type="CURRENCY" />
    <field number="677" name="LegBenchmarkCurveName" description="Name of
benchmark curve." type="STRING" />
    <field number="678" name="LegBenchmarkCurvePoint" description="Point on
benchmark curve." type="STRING" />
    <field number="679" name="LegBenchmarkPrice" description="Benchmark rate"
type="PRICE" />
    <field number="680" name="LegBenchmarkPriceType" description="The price type
of the LegBenchmarkPrice . &#xA;&#xA;See BenchmarkPriceType (663) for description and
valid values" type="INT" />
    <field number="681" name="LegBidPx" description="Bid price of this leg."
type="PRICE" />
    <field number="682" name="LegIOIQty" description="(e.g. number of shares) in
numeric form or relative size" type="STRING" />
    <field number="684" name="LegOfferPx" description="Offer price of this leg."
type="PRICE" />
    <field number="685" name="LegOrderQty" description="Order Quantity"
type="QTY" />
    <field number="686" name="LegPriceType" description="The price type of the
LegBidPx (68) and/or LegOfferPx (684). See PriceType (423) for description and
valid values" type="INT">
        <value enum="3" description="FIXED_AMOUNT" />
        <value enum="6" description="SPREAD" />

```



```

</field>
<field number="693" name="QuoteRespID" description="Quote Number"
type="STRING" />
<field number="694" name="QuoteRespType" description="Quote Response Type"
type="INT">
  <value enum="1" description="HIT_OR_LIFT" />
  <value enum="2" description="COUNTER" />
  <value enum="5" description="DONE_AWAY" />
</field>
<field number="699" name="BenchmarkSecurityID" description="The identifier of
the benchmark security, e.g. Treasury against Corporate bond.&#xA;See SecurityID
(tag 48) for description and valid values." type="STRING" />
<field number="707" name="PosAmtType" description="" type="STRING" />
<field number="708" name="PosAmt" description="" type="AMT" />
<field number="711" name="NoUnderlyings" description="Number of underlying
legs that make up the security." type="NUMINGROUP" />
<field number="715" name="ClearingBusinessDate" description=""
type="UTCDATEONLY" />
<field number="721" name="PosMaintRptID" description="" type="STRING" />
<field number="724" name="PosReqType" description="" type="INT">
  <value enum="0" description="POSITIONS" />
</field>
<field number="743" name="DeliveryDate" description="" type="UTCDATEONLY" />
<field number="751" name="TradeReportRejectReason" description=""
type="INT">
  <value enum="0" description="SUCCESSFUL_DEFAULT" />
  <value enum="5" description="MARGIN_ACCOUNT_FREEZING_FAILURE" />
</field>
<field number="753" name="NoPosAmt" description="" type="NUMINGROUP" />
<field number="761" name="BenchmarkSecurityIDSource" description="Identifies
class or source of the BenchmarkSecurityID (699) value. Required if
BenchmarkSecurityID is specified.&#xA;Same values as the SecurityIDSource (22)
field" type="STRING">
  <value enum="101" description="LEGSETTLTYPE_VALUE_101" />
  <value enum="102" description="LEGSETTLTYPE_VALUE_102" />
  <value enum="103" description="LEGSETTLTYPE_VALUE_103" />
</field>
<field number="773" name="ConfirmType" description="Identifies the type of
Confirmation message being sent." type="INT">
  <value enum="101" description="CONFIRMATION_FOR_CREDIT_LIMIT" />
</field>
<field number="781" name="NoSettlPartyIDs" description="" type="NUMINGROUP"
/>

```

```

    <field number="782" name="SettlPartyID" description="" type="STRING" />
    <field number="784" name="SettlPartyRole" description="Pay or receive flag"
type="STRING">
        <value enum="C" description="CREDIT" />
        <value enum="D" description="DEBIT" />
    </field>
    <field number="785" name="SettlPartySubID" description="PartySubID value
within a settlement parties component." type="STRING" />
    <field number="786" name="SettlPartySubIDType" description="Type of
SettlPartySubID (785) value." type="INT">
        <value enum="2" description="LEGSETTLTYPE_VALUE_2" />
        <value enum="5" description="LEGSETTLTYPE_VALUE_5" />
        <value enum="15" description="LEGSETTLTYPE_VALUE_15" />
        <value enum="16" description="LEGSETTLTYPE_VALUE_16" />
        <value enum="10" description="LEGSETTLTYPE_VALUE_10" />
        <value enum="22" description="LEGSETTLTYPE_VALUE_22" />
        <value enum="23" description="LEGSETTLTYPE_VALUE_23" />
        <value enum="101" description="LEGSETTLTYPE_VALUE_101" />
        <value enum="102" description="LEGSETTLTYPE_VALUE_102" />
        <value enum="110" description="LEGSETTLTYPE_VALUE_110" />
        <value enum="111" description="LEGSETTLTYPE_VALUE_111" />
        <value enum="112" description="LEGSETTLTYPE_VALUE_112" />
        <value enum="118" description="LEGSETTLTYPE_VALUE_118" />
        <value enum="123" description="LEGSETTLTYPE_VALUE_123" />
        <value enum="124" description="LEGSETTLTYPE_VALUE_124" />
        <value enum="125" description="LEGSETTLTYPE_VALUE_125" />
        <value enum="126" description="LEGSETTLTYPE_VALUE_126" />
    </field>
    <field number="789" name="NextExpectedMsgSeqNum" description="Next expected
MsgSeqNum value to be received." type="SEQNUM" />
    <field number="790" name="OrdStatusReqID" description="Order Status Request
ID" type="STRING" />
    <field number="791" name="SettlInstReqID" description="" type="STRING" />
    <field number="801" name="NoSettlParty" description="" type="NUMINGROUP" />
    <field number="802" name="NoPartySubIDs" description="Repeating group below
should contain unique combinations of PartySubID and PartySubIDType"
type="NUMINGROUP" />
    <field number="803" name="PartySubIDType" description="" type="INT">
        <value enum="2" description="TRADER_CODE" />
        <value enum="5" description="FULL_LEGAL_NAME_OF_FIRM" />
        <value enum="6" description="POSTAL_ADDRESS" />
        <value enum="7" description="PHONE_NUMBER" />
        <value enum="9" description="CONTACT_NAME" />

```

```

<value enum="10" description="SECURITIES_ACCOUNT_NUMBER" />
<value enum="15" description="CASH_ACCOUNT_NUMBER" />
<value enum="16" description="SWIFT_BIC_CODE" />
<value enum="22" description="SECURITIES_ACCOUNT_NAME" />
<value enum="23" description="CASH_ACCOUNT_NAME" />
<value enum="24" description="DEPARTMENT" />
<value enum="28" description="MARKET_MAKER" />
<value enum="101" description="TRADER_NAME" />
<value enum="102" description="SHORT_LEGAL_NAME_OF_FIRM" />
<value enum="103" description="CONTACT_METHOD_OF_TRADER" />
<value enum="104" description="MEMBERS_OR_CLIENTS" />
<value enum="105" description="NON_MARKET_MAKER" />
<value enum="106" description="MARGIN_SETTLEMENT_ACCOUNT_NUMBER" />
<value enum="107" description="MARGIN_CUSTODIAN_ACCOUNT_NUMBER" />
<value enum="108" description="MARGIN_SETTLEMENT_BANK_NAME" />
<value enum="109" description="MARGIN_CUSTODIAN_INSTITUTION_NAME" />
<value enum="110" description="SETTLEMENT_BANK_NAME" />
<value enum="111" description="CUSTODIAN_INSTITUTION_NAME" />
<value enum="112" description="SETTLEMENT_BANK_SORT_CODE" />
<value enum="113" description="CUSTODIAN_BANK_NAME" />
<value enum="114" description="CUSTODIAN_ACCOUNT_NAME" />
<value enum="115" description="CUSTODIAN_ACCOUNT_NUMBER" />
<value enum="116" description="MARGIN_SETTLEMENT_ACCOUNT_NAME" />
<value enum="117" description="MARGIN_CUSTODIAN_ACCOUNT_NAME" />
<value enum="118" description="CHINESE_NAME_OF_CASH_ACCOUNT" />
<value enum="119" description="STATUS_OF_SECURITIES_ACCOUNT" />
<value enum="120" description="STATUS_OF_CASH_ACCOUNT" />
<value enum="121" description="MARGIN_SETTLEMENT_BANK_SORT_CODE" />
<value enum="122" description="MARGIN_CUSTODIAN_ENTITY_CODE" />
<value enum="123" description="CUSTODIAN_ENTITY_CODE" />
<value enum="124" description="FULL_LEGAL_CHINESE_NAME_OF_FIRM" />
<value enum="125" description="SHORT_LEGAL_CHINESE_NAME_OF_FIRM" />
<value enum="126" description="TRADER_CHINESE_NAME" />
<value enum="127" description="ZIP_CODE" />
<value enum="128" description="CFETS_MARGIN_SETTLEMENT_ACCOUNT_NUMBER" />
<value enum="129" description="OTHER_MARGIN_SETTLEMENT_ACCOUNT_NUMBER" />
<value enum="130" description="FIRM_CODE" />
<value enum="131" description="MULTI_CURRENCY_ACCOUNT_DESCRIPTION" />
<value enum="132" description="COLLATERAL_MANAGEMENT_INSTITUTION_ID" />
<value enum="133" description="COLLATERAL_MANAGEMENT_INSTITUTION_NAME" />
<value enum="134" description="INSTITUTION_GROUP_NAME" />
<value enum="135" description="FIRM_ID" />
<value enum="137" description="CLEARING_INSTITUTION" />

```

```

<value enum="138" description="SETTLEMENT_CURRENCY_NAME" />
<value enum="139" description="SETTLEMENT_CURRENCY_REMARK" />
<value enum="140" description="CONTRA_CCY_SETTLEMENT_BANK_NAME" />
<value enum="141" description="CONTRA_CCY_CHINESE_NAME_OF_CASH_ACCOUNT" />
<value enum="142" description="CONTRA_CCY_ENGLISH_NAME_OF_CASH_ACCOUNT" />
<value enum="143" description="CONTRA_CCY_SWIFT_CODE" />
<value enum="144" description="CONTRA_CCY_NAME" />
<value enum="145" description="CONTRA_CCY_REMARK" />
<value enum="146" description="INTERNAL_GROUP_THE_TRADER_BELONGED_TO" />
</field>
<field number="810" name="UnderlyingPx" description="Underlying price
associate with a derivative instrument." type="PRICE" />
  <field number="854" name="QtyType" description="Type of quantity specified in
a Quantity field&#xA;0-Units (shares, par, currency)&#xA;1-Contracts (if used -
should specify ContractMultiplier (tag 23))" type="INT">
    <value enum="0" description="UNITS" />
    <value enum="1" description="CONTRACTS" />
  </field>
<field number="859" name="ConfirmReqID" description="Unique identifier for a
Confirmation Request message" type="STRING" />
  <field number="864" name="NoEvents" description="" type="NUMINGROUP" />
  <field number="865" name="EventType" description="" type="INT">
    <value enum="103" description="BANKRUPT" />
    <value enum="104" description="PAYMENT_DEFAULT" />
    <value enum="105" description="LOAN_MATURITY_ADVANCED" />
    <value enum="106" description="LOAN_DEFAULT" />
    <value enum="107" description="PAYMENT_CHANGED" />
    <value enum="108" description="OTHER" />
    <value enum="1" description="PUT" />
    <value enum="2" description="CALL" />
    <value enum="101" description="ISSUE_START_DATE" />
    <value enum="102" description="ISSUE_END_DATE" />
    <value enum="109" description="BOOK_KEEPING_DATE" />
    <value enum="110" description="DISTRIBUTION_START_DATE" />
    <value enum="111" description="DISTRIBUTION_END_DATE" />
    <value enum="112" description="UNDERWRITER_PAYMENT_DATE" />
    <value enum="113" description="REGISTRATION_DATE_ON_CREDIT_AND_DEBT" />
    <value enum="114" description="TRADING_DATE_IN_INTER_BANK" />
    <value enum="115" description="DELISTING_DATE_IN_INTER_BANK" />
    <value enum="116" description="TRADING_DATE_IN_EXCHANGE" />
    <value enum="117" description="DELISTING_DATE_IN_EXCHANGE" />
    <value enum="118" description="COUPON_RATE_INCREASES" />
    <value enum="119" description="MERGER_BOND_OPTION" />
  </field>

```

```

<value enum="120" description="REFUNDING_BOND_OPTION" />
<value enum="121" description="DEFERRED_PAYMENT_OPTIONS" />
<value enum="122" description="DIRECTIONAL_TRANSFER_OPTION" />
</field>
<field number="866" name="EventDate" description="" type="UTCDATEONLY" />
<field number="867" name="EventPx" description="" type="PRICE" />
<field number="868" name="EventText" description="" type="STRING" />
<field number="870" name="NoInstrAttrib" description="" type="NUMINGROUP" />
<field number="871" name="InstrAttribType" description="" type="INT">
  <value enum="1" description="FLAT" />
  <value enum="10" description="ORIGINAL_ISSUE_DISCOUNT" />
</field>
<field number="872" name="InstrAttribValue" description="" type="STRING" />
<field number="873" name="DatedDate" description="The effective date of a new
securities issue determined by its underwriters. Often but not always the same
as the Issue Date and the Interest Accrual Date" type="UTCDATEONLY" />
  <field number="874" name="InterestAccrualDate" description="FX: First period
start date" type="UTCDATEONLY" />
  <field number="879" name="UnderlyingQty" description="Total Face Value of
Underlying Instrument &#xA;Unit amount of the underlying security (par, shares,
currency, etc.)" type="QTY" />
  <field number="882" name="UnderlyingDirtyPrice" description="Price
(percent-of-par or per unit) of the underlying security or basket.
&quot;Dirty&quot; means it includes accrued interest" type="PRICE" />
  <field number="887" name="NoUnderlyingStips" description="Number of
underlying stipulation entries" type="NUMINGROUP" />
  <field number="888" name="UnderlyingStipType" description="Haircut
-Conversion Proportion;Yield - Yield or 1st Leg Yield;Yield2 - 2nd Leg
Yield;StopYield-STOPYIELD;StrikeYield - Strike Yield" type="STRING">
    <value enum="Haircut" description="CONVERSION_PROPORTION" />
    <value enum="Yield" description="YIELD_OR_1ST_LEG_YIELD" />
    <value enum="Yield2" description="SECOND_LEG_YIELD" />
    <value enum="StopYield" description="STOPYIELD" />
    <value enum="StrikeYield" description="STRIKE_YIELD" />
  </field>
  <field number="889" name="UnderlyingStipValue" description="Value of
stipulation.&#xA;Same values as StipulationValue (234)" type="STRING" />
  <field number="891" name="MiscFeeBasis" description="Defines the unit for a
miscellaneous fee.&#xA;Value values:&#xA;0 - Absolute&#xA;1 - Per unit&#xA;2 -
Percentage" type="INT">
    <value enum="0" description="ABSOLUTE" />
    <value enum="1" description="PER_UNIT" />
    <value enum="2" description="PERCENTAGE" />
  </field>

```

```

</field>
<field number="893" name="LastFragment" description="Indicates whether this
message is the last in a sequence of messages for those messages that support
fragmentation, such as Allocation Instruction, Mass Quote, Security List,
Derivative Security List" type="BOOLEAN">
  <value enum="Y" description="LAST_MESSAGE" />
  <value enum="N" description="NOT_LAST_MESSAGE" />
</field>
<field number="895" name="CollAsgnReason" description="" type="INT">
  <value enum="3" description="MARGIN_DEFICIENCY" />
</field>
<field number="902" name="CollAsgnID" description="" type="STRING" />
<field number="909" name="CollInquiryID" description="" type="STRING" />
<field number="911" name="TotNumReports" description="Total Number of
Execution Report &#xA;Can be used to identify the total number of Execution Reports
which will be returned." type="INT" />
  <field number="912" name="LastRptRequested" description="Can be used to
indicate that this is the last Execution Reports which will be returned as a result
of the request." type="BOOLEAN">
  <value enum="Y" description="YES" />
  <value enum="N" description="NO" />
</field>
  <field number="916" name="StartDate" description="Start date of a financing
deal, i.e. the date the buyer pays the seller cash and takes control of the
collateral" type="LOCALMKTDATE" />
  <field number="917" name="EndDate" description="End date of a financing deal,
i.e. the date the seller reimburses the buyer and takes back control of the
collateral" type="LOCALMKTDATE" />
  <field number="919" name="DeliveryType" description="Settlement Method"
type="INT">
  <value enum="0" description="DVP" />
  <value enum="4" description="PUD" />
  <value enum="5" description="DUP" />
  <value enum="6" description="BVB" />
  <value enum="7" description="NONE" />
  <value enum="8" description="BVBF" />
  <value enum="9" description="BVP" />
  <value enum="10" description="CSH" />
  <value enum="11" description="NDVP" />
  <value enum="99" description="OTHER" />
</field>
  <field number="923" name="UserRequestID" description="Unique identifier for
a User Request." type="STRING" />

```

```

<field number="924" name="UserRequestType" description="Indicates the action
required by a User Request Message.Valid values: 1 - LogOnUser; 2 - LogOffUser;
3 - Change Password For User; 4 - Request Individual User Status" type="INT">
  <value enum="1" description="LOGONUSER" />
  <value enum="2" description="LOGOFFUSER" />
  <value enum="3" description="CHANGEPASSWORDFORUSER" />
  <value enum="4" description="REQUEST_INDIVIDUAL_USER_STATUS" />
</field>
<field number="926" name="UserStatus" description="Indicates the status of a
user.Valid values: 1 - Logged In; 2 - Not Logged In; 3 - User Not Recognised; 4
- Password Incorrect; 5 - Password Changed; 6 -
Other;7-User_bad_compId;8-User_bad_subcompId;9-wrong password
format;10-active;11-inactive" type="INT">
  <value enum="1" description="LOGGED_IN" />
  <value enum="2" description="NOT_LOGGED_IN" />
  <value enum="3" description="USER_NOT_RECOGNISED" />
  <value enum="4" description="PASSWORD_INCORRECT" />
  <value enum="5" description="PASSWORD_CHANGED" />
  <value enum="6" description="OTHER" />
  <value enum="7" description="USER_BAD_COMPID" />
  <value enum="8" description="USER_BAD_SUBCOMPID" />
  <value enum="9" description="WRONG_PASSWORD_FORMAT" />
  <value enum="10" description="ACTIVE" />
  <value enum="11" description="INACTIVE" />
</field>
<field number="927" name="UserStatusText" description="A text description
associated with a user status." type="STRING" />
<field number="939" name="TrdRptStatus" description="" type="INT">
  <value enum="0" description="ACCEPTED" />
  <value enum="1" description="REJECTED" />
</field>
<field number="956" name="LegInterestAccrualDate" description="First Fixing
date" type="UTCDATEONLY" />
<field number="963" name="MDReportID" description="" type="INT" />
<field number="964" name="SecurityReportID" description="" type="STRING" />
<field number="965" name="SecurityStatus" description="Security Status&#xA;1
- Active&#xA;2 - Inactive" type="CHAR">
  <value enum="1" description="ACTIVE" />
  <value enum="2" description="INACTIVE" />
</field>
<field number="975" name="UnderlyingSettlementType" description="Indicates
order settlement period for the underlying instrument.&#xA;Valid Values:&#xA;2
- T+1&#xA;4 - T+3&#xA;5 - T+4" type="INT">

```



```

    <value enum="2" description="T_PLUS_1" />
    <value enum="4" description="T_PLUS_3" />
    <value enum="5" description="T_PLUS_4" />
</field>
<field number="980" name="SecurityUpdateAction" description="" type="CHAR">
    <value enum="R" description="REPLACE" />
    <value enum="A" description="ADD" />
    <value enum="D" description="DELETE" />
    <value enum="M" description="MODIFY" />
</field>
<field number="1036" name="ExecAckStatus" description="0 - Received, not yet
processed 1 - Accepted 2 - Don't know or Rejected" type="CHAR">
    <value enum="0" description="RECEIVED_BUT_NOT_YET_PROCESSED" />
    <value enum="1" description="ACCEPTED" />
    <value enum="2" description="DO_NOT_KNOW_OR_REJECTED" />
</field>
<field number="1043" name="CollApplType" description="" type="INT">
    <value enum="2" description="COLLATERAL" />
    <value enum="3" description="PLEDGE" />
    <value enum="4" description="MORTGAGE" />
</field>
<field number="1056" name="CalculatedCcyLastQty" description="FX Market: Leg
Contra Amount" type="QTY" />
    <field number="1067" name="LegBidForwardPoints" description="The bid FX
forward points for the leg of an FX Swap. Value can be negative. Expressed in decimal
form." type="PRICEOFFSET" />
    <field number="1068" name="LegOfferForwardPoints" description="The offer FX
forward points for the leg of an FX Swap. Value can be negative. Expressed in decimal
form." type="PRICEOFFSET" />
    <field number="1071" name="LastSwapPoints" description="SWAP Points"
type="PRICEOFFSET" />
    <field number="1073" name="LegLastForwardPoints" description="FX Market: Leg
Spot Rate" type="FLOAT" />
    <field number="1074" name="LegCalculatedCcyLastQty" description="FX Market:
Leg Contra Amount" type="FLOAT" />
    <field number="1138" name="DisplayQty" description="The quantity to be
displayed . Required for reserve orders. On orders specifies the qty to be displayed,
on execution reports the currently displayed quantity." type="QTY" />
    <field number="1158" name="NoSettlDetails" description="" type="NUMINGROUP"
/>
    <field number="1159" name="SettlObligMode" description="&lt;span
class="quote">&lt;/span>" type="INT">
    <value enum="0" description="OVERDUE" />

```



```

    <value enum="1" description="PRELIMINARY" />
    <value enum="2" description="FINAL" />
    <value enum="101" description="REPAYMENT_FOR_OVERDUE" />
    <value enum="102" description="ACTUAL_RECEIVING_PAYMENT" />
  </field>
  <field number="1160" name="SettlObligMsgID" description="" type="STRING" />
  <field number="1161" name="SettlObligID" description="Unique ID for this
settlement instruction." type="STRING" />
  <field number="1162" name="SettlObligTransType" description="Settlement
Obligation Transaction Type" type="CHAR">
    <value enum="C" description="CANCEL" />
    <value enum="N" description="NEW" />
    <value enum="R" description="REPLACE" />
    <value enum="O" description="ORDINARY" />
  </field>
  <field number="1163" name="SettlObligRefID" description="Settlement
Obligation Reference ID." type="STRING" />
  <field number="1165" name="NoSettlOblig" description="" type="NUMINGROUP" />
  <field number="1188" name="Volatility" description="" type="FLOAT" />
  <field number="1227" name="ProductComplex" description="Identifies an entire
suite of products for a given market." type="STRING" />
  <field number="1265" name="DerivativeOptAttribute" description="Option
Attribute" type="CHAR">
    <value enum="0" description="ATM" />
    <value enum="1" description="PUT_10D" />
    <value enum="2" description="CALL_10D" />
    <value enum="3" description="PUT_25D" />
    <value enum="4" description="CALL_25D" />
  </field>
  <field number="1299" name="DerivativeExerciseStyle" description=""
type="CHAR">
    <value enum="0" description="EUROPEAN" />
  </field>
  <field number="1301" name="MarketID" description="" type="STRING">
    <value enum="0" description="XSHG" />
    <value enum="1" description="XSHE" />
    <value enum="2" description="INTER_BANK" />
    <value enum="3" description="COUNTER_MARKET" />
  </field>
  <field number="1409" name="SessionStatus" description="" type="INT">
    <value enum="0" description="SESSION_ACTIVE" />
    <value enum="4" description="SESSION_LOGOUT_COMPLETE" />
    <value enum="7" description="LOGONS_ARE_NOT_ALLOWED_AT_THIS_TIME" />
  </field>

```

```

    <value enum="9" description="LOGOUT_FAILED" />
</field>
<field number="1465" name="SecurityListID" description="" type="STRING" />
<field number="1470" name="SecurityListType" description="" type="INT">
    <value enum="101" description="COLLATERAL_SECURITIES_LIST" />
    <value enum="102" description="SPECIFIC_COLLATERAL_SECURITY_DEFINED_LIST"
/>
    <value enum="103"
description="COLLATERAL_SECURITIES_DEFINED_LIST_IN_SPECIFIC_DATE" />
    <value enum="104" description="MARKET_MAKING_SECURITY_LIST" />
</field>
<field number="1482" name="OptPayoutType" description="" type="INT">
    <value enum="1" description="VANILLA" />
</field>
<field number="1483" name="NoComplexEvents" description="" type="NUMINGROUP"
/>
<field number="1484" name="ComplexEventType" description="" type="INT">
    <value enum="101" description="PUT" />
    <value enum="102" description="CALL" />
</field>
<field number="1486" name="ComplexEventPrice" description="" type="PRICE" />
<field number="1487" name="ComplexEventPriceBoundaryMethod" description=""
type="INT">
    <value enum="5" description="GREATER_THAN_COMPLEXEVENTPRICE" />
    <value enum="1" description="LESS_THAN_COMPLEXEVENTPRICE" />
    <value enum="2" description="LESS_THAN_OR_EQUAL_TO_COMPLEXEVENTPRICE" />
    <value enum="3" description="EQUAL_TO_COMPLEXEVENTPRICE" />
    <value enum="4" description="GREATER_THAN_OR_EQUAL_TO_COMPLEXEVENTPRICE"
/>
</field>
<field number="1491" name="NoComplexEventDates" description=""
type="NUMINGROUP" />
    <field number="1492" name="ComplexEventStartDate" description=""
type="UTCTIMESTAMP" />
    <field number="1493" name="ComplexEventEndDate" description=""
type="UTCTIMESTAMP" />
    <field number="1505" name="PartyDetailsListRequestID" description=""
type="STRING" />
    <field number="1510" name="PartyDetailsListReportID" description=""
type="STRING" />
    <field number="1512" name="TotNoPartyList" description="Total number of
PartyListGrp returned" type="INT" />
    <field number="1513" name="NoPartyList" description="Number of PartyListGrp"

```

```

type="NUMINGROUP" />
  <field number="1529" name="NoRiskLimits" description="Number of RiskLimits"
type="NUMINGROUP" />
  <field number="1530" name="RiskLimitType" description="Used to specify the
type of risk limit amount of position limit quantity" type="INT">
    <value enum="1" description="GROSS_LIMIT" />
    <value enum="2" description="NET_LIMIT" />
  </field>
  <field number="1531" name="RiskLimitAmount" description="Specifies the risk
limit amount.</span>&#xD;&#xA;</div>" type="AMT" />
  <field number="10000" name="AccountInfoID" description="Account Information"
type="STRING" />
  <field number="10001" name="AccountInfoIDType" description="Account
Information Type" type="CHAR">
    <value enum="0" description="CUSTODIAN_ACCOUNT_DATA" />
    <value enum="1" description="SETTLEMENT_ACCOUNT_DATA" />
  </field>
  <field number="10002" name="AccruedInterestTotalAmt" description="Total
Accrued Interest" type="AMT" />
  <field number="10003" name="ActualMaturityDate" description="Specifies date
of maturity (a full date). Note that standardized derivatives which are typically
only referenced by month and year (e.g. S&amp;P futures).may use
MaturityMonthYear and/or this field. When using MaturityMonthYear, it is
recommended that markets and sell sides report the MaturityDate on all outbound
messages as a means of data enrichment." type="UTCDATEONLY" />
  <field number="10004" name="NoBenchmarks" description="NoBenchmarks"
type="NUMINGROUP" />
  <field number="10005" name="LimitInfoType" description="" type="INT">
    <value enum="0" description="PBOC_LIMIT" />
    <value enum="1" description="AUTHORITY_BETWEEN_HEAD_OFFICE_AND_BRANCHES"
/>
    <value enum="2" description="AUTHORITY_BETWEEN_PARTIES" />
    <value enum="3" description="SINGLE_LIMT" />
    <value enum="4" description="TRADE_LIMIT" />
    <value enum="5" description="SETTLEMENT_LIMIT" />
    <value enum="6" description="SINGLE_DAY_TRADING_LIMIT_MARKET_MAKING_LIMIT"
/>
  </field>
  <field number="10006" name="AnnouncementDate" description="Announcement
Date" type="UTCDATEONLY" />
  <field number="10007" name="NoQueryResult" description="" type="NUMINGROUP"
/>
  <field number="10008" name="AnonymousIndicator"

```

```

description="AnonymousIndicator" type="BOOLEAN">
  <value enum="Y" description="YES" />
  <value enum="N" description="NO" />
</field>
<field number="10009" name="CouponPaymentDateReset" description="Payment
date adjustment&#xA;0 - Preceding Day&#xA;1 - Following Day&#xA;2 - Modified
Following" type="CHAR">
  <value enum="0" description="PRECEDING_DAY" />
  <value enum="1" description="FOLLOWING_DAY" />
  <value enum="2" description="MODIFIED_FOLLOWING" />
</field>
<field number="10010" name="PreDealFlag" description="Pre deal report
indicator&#xA;Y- Valid Deal&#xA;N- Invalid Deal" type="BOOLEAN">
  <value enum="Y" description="VALID_DEAL" />
  <value enum="N" description="INVALID_DEAL" />
</field>
<field number="10011" name="StartSeqNo" description="" type="SEQNUM" />
<field number="10012" name="GrossOrNet" description="Gross limit or net limit"
type="INT">
  <value enum="0" description="GROSS_LIMIT" />
  <value enum="1" description="NET_LIMIT" />
  <value enum="2" description="OTHER" />
</field>
<field number="10013" name="CalcMethod" description="0 -Weighted Average 1
-Simple Average 2 -Median 3-arithmetic weighted average 4-index weighted average"
type="INT">
  <value enum="0" description="WEIGHTED_AVERAGE" />
  <value enum="1" description="SIMPLE_AVERAGE" />
  <value enum="2" description="MEDIAN" />
  <value enum="3" description="ARITHMETIC_WEIGHTED_AVERAGE" />
  <value enum="4" description="INDEX_WEIGHTED_AVERAGE" />
</field>
<field number="10014" name="CashHoldingDays" description="Actual occupancy
days" type="NUMBER" />
<field number="10015" name="CashPaymentType" description="0 - Initial
Exchange&#xA;1 - Front Stub&#xA;2 - Back Stub&#xA;3 - Regular Payment" type="INT">
  <value enum="0" description="INITIAL_EXCHANGE" />
  <value enum="1" description="FRONT_STUB" />
  <value enum="2" description="BACK_STUB" />
  <value enum="3" description="REGULAR_PAYMENT" />
</field>
<field number="10016" name="CashSubPropCap" description="Cash Substitution
proportion cap" type="PERCENTAGE" />

```

```

    <field number="10017" name="CirculationSize" description="Circulation size"
type="AMT" />
    <field number="10018" name="InterestAccuralDaysAdjustment"
description="Interest Accural Days Adjustment&#xA;0-No Adjustment(Default)?
&#xA;1-Actual Days" type="CHAR">
        <value enum="0" description="NO_ADJUSTMENT" />
        <value enum="1" description="ACTUAL_DAYS" />
    </field>
    <field number="10019" name="DealSerialNo" description="Deal Serial Number"
type="STRING" />
    <field number="10020" name="LegBenchmarkTenor"
description="7D&#xA;3M&#xA;6M&#xA;9M&#xA;1Y;2Y;3Y;4Y;5Y;6Y;7Y;8Y;9Y;10Y;11Y;1
2Y;13Y;14Y;15Y;20Y" type="STRING">
        <value enum="7D" description="LEGSETTLTYPE_VALUE_7D" />
        <value enum="1W" description="LEGSETTLTYPE_VALUE_1W" />
        <value enum="2W" description="LEGSETTLTYPE_VALUE_2W" />
        <value enum="3W" description="LEGSETTLTYPE_VALUE_3W" />
        <value enum="1M" description="LEGSETTLTYPE_VALUE_1M" />
        <value enum="2M" description="LEGSETTLTYPE_VALUE_2M" />
        <value enum="3M" description="LEGSETTLTYPE_VALUE_3M" />
        <value enum="4M" description="LEGSETTLTYPE_VALUE_4M" />
        <value enum="5M" description="LEGSETTLTYPE_VALUE_5M" />
        <value enum="6M" description="LEGSETTLTYPE_VALUE_6M" />
        <value enum="7M" description="LEGSETTLTYPE_VALUE_7M" />
        <value enum="8M" description="LEGSETTLTYPE_VALUE_8M" />
        <value enum="9M" description="LEGSETTLTYPE_VALUE_9M" />
        <value enum="10M" description="LEGSETTLTYPE_VALUE_10M" />
        <value enum="11M" description="LEGSETTLTYPE_VALUE_11M" />
        <value enum="1Y" description="LEGSETTLTYPE_VALUE_1Y" />
        <value enum="2Y" description="LEGSETTLTYPE_VALUE_2Y" />
        <value enum="3Y" description="LEGSETTLTYPE_VALUE_3Y" />
        <value enum="4Y" description="LEGSETTLTYPE_VALUE_4Y" />
        <value enum="5Y" description="LEGSETTLTYPE_VALUE_5Y" />
        <value enum="6Y" description="LEGSETTLTYPE_VALUE_6Y" />
        <value enum="7Y" description="LEGSETTLTYPE_VALUE_7Y" />
        <value enum="8Y" description="LEGSETTLTYPE_VALUE_8Y" />
        <value enum="9Y" description="LEGSETTLTYPE_VALUE_9Y" />
        <value enum="10Y" description="LEGSETTLTYPE_VALUE_10Y" />
        <value enum="11Y" description="LEGSETTLTYPE_VALUE_11Y" />
        <value enum="12Y" description="LEGSETTLTYPE_VALUE_12Y" />
        <value enum="13Y" description="LEGSETTLTYPE_VALUE_13Y" />
        <value enum="14Y" description="LEGSETTLTYPE_VALUE_14Y" />
        <value enum="15Y" description="LEGSETTLTYPE_VALUE_15Y" />

```

```

    <value enum="20Y" description="LEGSETTLTYPE_VALUE_20Y" />
  </field>
  <field number="10021" name="ConstituentIndicator" description="Constituent
Indicator" type="INT">
    <value enum="0" description="NO" />
    <value enum="1" description="YES" />
  </field>
  <field number="10022" name="ContingencyIndicator" description="Contingency
indicator" type="BOOLEAN">
    <value enum="Y" description="YES" />
    <value enum="N" description="NO" />
  </field>
  <field number="10023" name="ConvertDate" description="Conversion Date"
type="UTCDATEONLY" />
  <field number="10024" name="ConvertIndicator" description="Convertible
Indicator" type="BOOLEAN">
    <value enum="Y" description="YES" />
    <value enum="N" description="NO" />
  </field>
  <field number="10025" name="ConvertOfFaceValue" description="Convert Face
Value" type="AMT" />
  <field number="10026" name="ConvertPx" description="Conversion Price"
type="PRICE" />
  <field number="10027" name="ConvertType" description="Conversion Type"
type="CHAR">
    <value enum="0" description="PARTIAL" />
    <value enum="1" description="FULL" />
  </field>
  <field number="10028" name="CouponCapRate" description="Coupon Cap Rate"
type="PRICE" />
  <field number="10029" name="CouponFloorRate" description="Coupon Floor Rate"
type="PRICE" />
  <field number="10030" name="CouponPaymentFrequency" description="Coupon
Frequency" type="INT">
    <value enum="0" description="SEMI_ANNUALLY" />
    <value enum="1" description="ANNUALLY" />
    <value enum="2" description="MATURITY" />
    <value enum="3" description="MONTHLY" />
    <value enum="4" description="QUARTERLY" />
    <value enum="5" description="BIWEEKLY" />
    <value enum="6" description="WEEKLY" />
    <value enum="7" description="DAILY" />
    <value enum="8" description="TEN_DAYS" />

```

```

    <value enum="9" description="NINE_MONTHS" />
    <value enum="10" description="IN_ADVANCE" />
    <value enum="11" description="IM" />
    <value enum="12" description="OTHER" />
  </field>
  <field number="10031" name="CouponRateType" description="Coupon Rate Type"
type="INT">
    <value enum="0" description="FIXED" />
    <value enum="1" description="FLOATING" />
    <value enum="2" description="ZERO_COUPON" />
    <value enum="3" description="DISCOUNT" />
    <value enum="4" description="CHANGEABLE" />
    <value enum="5" description="IM" />
  </field>
  <field number="10032" name="CreditRatingAgency" description="Credit Rating
Agency" type="STRING">
    <value enum="0" description="DAGONG_GLOBAL_CREDIT_RATING_CO_LTD" />
    <value enum="1" description="CCXI_CREDIT_RATING_CO_LTD" />
    <value enum="2" description="CHINA_LIANHE_CREDIT_RATING_CO_LTD" />
    <value enum="3"
description="SHANGHAI_BRILLIANCE_CREDIT_RATING_AND_INVESTORS_SERVICE_CO_LTD"
/>
    <value enum="4" description="SHANGHAI_FAREAST_CREDIT_RATING_CO_LTD" />
    <value enum="5" description="PENGYUAN_CREDIT_RATING_CO_LTD" />
    <value enum="6" description="GOLDEN_CREDIT_RATING_INTERNATIONAL_CO_LTD" />
  </field>
  <field number="10033" name="CreditValidityFrom" description="Start date for
credit rating." type="UTCDATEONLY" />
  <field number="10034" name="CreditValidityTo" description="End date for credit
rating" type="UTCDATEONLY" />
  <field number="10035" name="CumulativeFaceValue" description="Cumulative
Face Value of all orders" type="AMT" />
  <field number="10036" name="NotionalExchangeType" description=""
type="NUMINGROUP">
    <value enum="0" description="START_AND_END" />
    <value enum="1" description="START_ONLY" />
    <value enum="2" description="END_ONLY" />
    <value enum="3" description="NONE" />
  </field>
  <field number="10037" name="DataDownloadType" description="" type="INT">
    <value enum="1" description="SELF_QUOTATION_INFO" />
    <value enum="2" description="SELF_DEAL_INFO" />
    <value enum="3" description="AFFILIATE_DEAL_INFO" />

```

```

<value enum="4" description="MARKET_QUOTATION_INFO" />
<value enum="5" description="MARKET_DEAL_INFO" />
<value enum="6" description="RMB_MARKET_STATISTICS" />
<value enum="7" description="BOND_INFO" />
<value enum="8" description="ABS_INFO" />
<value enum="9" description="ETF_INFO" />
<value enum="10" description="PARTY_CONTACT_INFO" />
<value enum="11" description="PARTY_ACCOUNT_INFO" />
<value enum="12" description="AUTHORITY_BETWEEN_HEAD_OFFICE_AND_BRANCHES"
/>
<value enum="13" description="AUTHORITY_BETWEEN_PARTIES" />
<value enum="14" description="SINGLE_LIMIT" />
<value enum="15" description="TRADE_LIMIT" />
<value enum="16" description="SETTLEMENT_LIMIT" />
<value enum="17" description="SHIBOR_RATE" />
<value enum="18" description="BENCHMARK_RATE" />
<value enum="19" description="ONE_WEEK_REPO_WEIGHTED_RATE" />
<value enum="20" description="HISTORY_INFO" />
<value enum="22" description="FX_MARKET_STATISTICS" />
</field>
<field number="10038" name="DataSource" description="(FX Market: Set with
fixed value 22)" type="STRING">
  <value enum="22" description="LEGSETTLTYPE_VALUE_22" />
</field>
<field number="10039" name="DateConfirmed" description="(FX Market)Date
Confirmed)(GMT+8)" type="UTCDATEONLY" />
<field number="10040" name="DayCount" description="Day Count
Convention&#xD; &#xA;" type="CHAR">
  <value enum="0" description="ACTUAL_DIVIDE_ACTUAL" />
  <value enum="1" description="ACT_DIVIDE_360" />
  <value enum="2" description="THIRTY_DIVIDE_360" />
  <value enum="3" description="A_DIVIDE_365" />
  <value enum="4" description="ISMA30_DIVIDE_360" />
  <value enum="5" description="A_DIVIDE_365F" />
  <value enum="6" description="THIRTY_DIVIDE_365" />
  <value enum="7" description="THIRTY_DIVIDE_ACT" />
  <value enum="8" description="THIRTY_DIVIDE_366" />
  <value enum="9" description="RANG_ACT_DIVIDE_ACT" />
  <value enum="A" description="RANG_ACT_DIVIDE_360" />
  <value enum="B" description="RANG_ACT_DIVIDE_365" />
  <value enum="C" description="RANG_ACT_DIVIDE_366" />
</field>
<field number="10041" name="DealID" description="Deal ID" type="STRING" />

```



```

    <field number="10042" name="DealMethod" description="(FX Market: Set with
fixed value MT)Deal Method" type="STRING">
        <value enum="MT" description="LEGSETTLTYPE_VALUE_MT" />
    </field>
    <field number="10043" name="DelistDate" description="Date instrument was
issued. For Fixed Income IOIs for new issues, specifies the issue date."
type="UTCDATEONLY" />
    <field number="10044" name="DeliveryOptionDirection" description="Delivery
Option Direction" type="CHAR">
        <value enum="1" description="BUY" />
        <value enum="4" description="SEL" />
    </field>
    <field number="10045" name="DeliveryType2" description="2nd leg Settlement
method 0 - DVP 4 - PUD 5 - DUP 6 - BVB 7 - NONE;8 - BVBF;9 - BVP" type="INT">
        <value enum="0" description="DVP" />
        <value enum="4" description="PUD" />
        <value enum="5" description="DUP" />
        <value enum="6" description="BVB" />
        <value enum="7" description="NONE" />
        <value enum="8" description="BVBF" />
        <value enum="9" description="BVP" />
    </field>
    <field number="10046" name="QueryTime" description="" type="UTCTIMESTAMP" />
    <field number="10047" name="DeliveryTypeOption" description="1st leg
Settlement method option" type="CHAR">
        <value enum="0" description="DVP" />
        <value enum="4" description="PUD" />
        <value enum="5" description="DUP" />
        <value enum="6" description="BVB" />
        <value enum="7" description="NONE" />
        <value enum="8" description="BVBF" />
        <value enum="9" description="BVP" />
        <value enum="A" description="CSH" />
        <value enum="B" description="NDVP" />
        <value enum="Z" description="OTHER" />
    </field>
    <field number="10048" name="DirtyPrice" description="Dirty Price"
type="PRICE" />
    <field number="10049" name="DirtyPrice2" description="1st Leg Dirty Price;2nd
leg Dirty Price" type="PRICE" />
    <field number="10050" name="DiscountRate" description="DiscountRate"
type="STRING" />
    <field number="10051" name="DisputeSettlementMethod" description="Dispute

```

```

Settlement Method" type="INT">
    <value enum="0" description="ARBITRATION" />
    <value enum="1" description="LITIGATION" />
</field>
<field number="10052" name="ErrorCode" description="It's required field for
fixed income system e.g. NGCNYTS to transfer error code defined in NGCNYTS."
type="STRING" />
<field number="10053" name="FaceValue" description="The face value of a bond,
exclusive of accrued interest and payable at maturity." type="AMT" />
<field number="10054" name="FirstPeriodStartDate" description="First period
start date" type="UTCDATEONLY" />
<field number="10055" name="TotalDealCount" description="" type="INT" />
<field number="10056" name="TotalValidDealCount" description="" type="INT" />
<field number="10057" name="FundCustodian" description="Fund Custodian"
type="STRING" />
<field number="10058" name="FundManager" description="Fund Manager"
type="STRING" />
<field number="10059" name="GroupID" description="Unique inditator of group
to demonstrate the name of the group" type="STRING" />
<field number="10060" name="GroupRole" description="Group Role"
type="STRING">
    <value enum="101" description="INITIATOR_GROUP" />
    <value enum="102" description="COUNTERPARTY_GROUP" />
    <value enum="104" description="CLEARING_BANK" />
    <value enum="105" description="CUSTODIAN_INSTITUTION" />
    <value enum="106" description="CUSTODIAN_BANK" />
    <value enum="107" description="SETTLEMENT_AGENT" />
    <value enum="108" description="MARGIN_MANAGEMENT_INSTITUTION" />
    <value enum="109" description="MARGIN_CUSTODIAN_INSTITUTION" />
    <value enum="110" description="MARGIN_AGENT" />
    <value enum="111" description="CONTINGENCY_PARTY" />
</field>
<field number="10061" name="HaltedPeriodFrom" description="Shut Period From
Date" type="UTCDATEONLY" />
<field number="10062" name="HaltedPeriodReason" description="Reason for Shut
Period" type="STRING" />
<field number="10063" name="HaltedPeriodTo" description="Shut Period To Date"
type="UTCDATEONLY" />
<field number="10064" name="Currency1" description="" type="CURRENCY" />
<field number="10065" name="Currency2" description="" type="CURRENCY" />
<field number="10066" name="CouponPaymentIndicator" description=""
type="BOOLEAN">
    <value enum="Y" description="YES" />

```

```

    <value enum="N" description="NO" />
</field>
<field number="10067" name="IndexOfPresentTotalValue" description="Total Net
value of fund" type="AMT" />
<field number="10068" name="IniExAmount" description="Initial exchange
amount" type="AMT" />
<field number="10069" name="IniExDate" description="Initial exchange date"
type="UTCDATEONLY" />
<field number="10070" name="IniExDirIndicator" description="Initial exchange
direction 1-Buy 4-Sell" type="CHAR">
    <value enum="1" description="BUY" />
    <value enum="4" description="SELL" />
</field>
<field number="10071" name="IniExReqIndicator" description="Initial exchange
indicator" type="BOOLEAN">
    <value enum="Y" description="YES" />
    <value enum="N" description="NO" />
</field>
<field number="10072" name="InterestAccrualMethod" description="Interest
rate accrued method&#xA;0 - Simple&#xA;1 - Compound" type="CHAR">
    <value enum="0" description="SIMPLE" />
    <value enum="1" description="COMPOUND" />
</field>
<field number="10073" name="InterestFixDate" description="Fixing Date"
type="UTCDATEONLY" />
<field number="10074" name="InterestFixDateAdjustment" description="Fixing
Date Adjustment &#xD;&#xA;0 - Preceding Day&#xD;&#xA;1 - Following Day&#xD;&#xA;2
- Modified Following&#xD;&#xA;3 - Current Day" type="CHAR">
    <value enum="0" description="PRECEDING_DAY" />
    <value enum="1" description="FOLLOWING_DAY" />
    <value enum="2" description="MODIFIED_FOLLOWING" />
    <value enum="3" description="CURRENT_DAY" />
    <value enum="4" description="TWO_DAYS_BEFORE" />
    <value enum="5" description="FIVE_DAYS_BEFORE" />
    <value enum="6" description="OTHER" />
</field>
<field number="10075" name="IOPValue" description="IOPValue" type="PRICE" />
<field number="10076" name="IssuePx" description="Issue price" type="PRICE"
/>
<field number="10077" name="IssuerShotName" description="Issuer's short name"
type="STRING" />
<field number="10078" name="IssueSize" description="Issue size" type="AMT" />
<field number="10079" name="LastIOPValue" description="LastIOPValue"

```

```
type="PRICE" />
<field number="10080" name="MaturityDateType" description="" type="STRING">
  <value enum="BROKEN" description="LEGSETTLTYPE_VALUE_BROKEN" />
  <value enum="7D" description="LEGSETTLTYPE_VALUE_7D" />
  <value enum="2W" description="LEGSETTLTYPE_VALUE_2W" />
  <value enum="3W" description="LEGSETTLTYPE_VALUE_3W" />
  <value enum="1M" description="LEGSETTLTYPE_VALUE_1M" />
  <value enum="2M" description="LEGSETTLTYPE_VALUE_2M" />
  <value enum="3M" description="LEGSETTLTYPE_VALUE_3M" />
  <value enum="4M" description="LEGSETTLTYPE_VALUE_4M" />
  <value enum="5M" description="LEGSETTLTYPE_VALUE_5M" />
  <value enum="6M" description="LEGSETTLTYPE_VALUE_6M" />
  <value enum="9M" description="LEGSETTLTYPE_VALUE_9M" />
  <value enum="1Y" description="LEGSETTLTYPE_VALUE_1Y" />
  <value enum="2Y" description="LEGSETTLTYPE_VALUE_2Y" />
  <value enum="3Y" description="LEGSETTLTYPE_VALUE_3Y" />
  <value enum="4Y" description="LEGSETTLTYPE_VALUE_4Y" />
  <value enum="5Y" description="LEGSETTLTYPE_VALUE_5Y" />
  <value enum="6Y" description="LEGSETTLTYPE_VALUE_6Y" />
  <value enum="7Y" description="LEGSETTLTYPE_VALUE_7Y" />
  <value enum="8Y" description="LEGSETTLTYPE_VALUE_8Y" />
  <value enum="9Y" description="LEGSETTLTYPE_VALUE_9Y" />
  <value enum="10Y" description="LEGSETTLTYPE_VALUE_10Y" />
  <value enum="11Y" description="LEGSETTLTYPE_VALUE_11Y" />
  <value enum="12Y" description="LEGSETTLTYPE_VALUE_12Y" />
  <value enum="13Y" description="LEGSETTLTYPE_VALUE_13Y" />
  <value enum="14Y" description="LEGSETTLTYPE_VALUE_14Y" />
  <value enum="15Y" description="LEGSETTLTYPE_VALUE_15Y" />
  <value enum="16Y" description="LEGSETTLTYPE_VALUE_16Y" />
  <value enum="17Y" description="LEGSETTLTYPE_VALUE_17Y" />
  <value enum="18Y" description="LEGSETTLTYPE_VALUE_18Y" />
  <value enum="19Y" description="LEGSETTLTYPE_VALUE_19Y" />
  <value enum="20Y" description="LEGSETTLTYPE_VALUE_20Y" />
  <value enum="21Y" description="LEGSETTLTYPE_VALUE_21Y" />
  <value enum="22Y" description="LEGSETTLTYPE_VALUE_22Y" />
  <value enum="23Y" description="LEGSETTLTYPE_VALUE_23Y" />
  <value enum="24Y" description="LEGSETTLTYPE_VALUE_24Y" />
  <value enum="25Y" description="LEGSETTLTYPE_VALUE_25Y" />
  <value enum="26Y" description="LEGSETTLTYPE_VALUE_26Y" />
  <value enum="27Y" description="LEGSETTLTYPE_VALUE_27Y" />
  <value enum="28Y" description="LEGSETTLTYPE_VALUE_28Y" />
  <value enum="29Y" description="LEGSETTLTYPE_VALUE_29Y" />
  <value enum="30Y" description="LEGSETTLTYPE_VALUE_30Y" />

```

```

    <value enum="40Y" description="LEGSETTLTYPE_VALUE_40Y" />
    <value enum="50Y" description="LEGSETTLTYPE_VALUE_50Y" />
</field>
<field number="10081" name="QuoteMethod" description="" type="CHAR">
    <value enum="1" description="MARKET" />
    <value enum="2" description="GROUP" />
    <value enum="3" description="ONE_TO_ONE_USER" />
    <value enum="4" description="ONE_TO_ONE_ENTITY" />
</field>
<field number="10082" name="SettlDateTerm" description="" type="NUMBER" />
<field number="10083" name="LastSubRedempMinUnit" description="Minimum
Subscription Unit Value 或 Minimum Redemption Unit Value" type="AMT" />
    <field number="10084" name="LastTradeCashSpread" description="Cash Spread"
type="PRICEOFFSET" />
    <field number="10085" name="LastTradeDate" description="Last trading date"
type="UTCDATEONLY" />
    <field number="10086" name="LegSolveForIndicator" description=""
type="BOOLEAN">
    <value enum="Y" description="YES" />
    <value enum="N" description="NO" />
</field>
    <field number="10087" name="LeavesTotalQty" description="Leave quantity"
type="AMT" />
    <field number="10088" name="LegAccruedInterestAmt" description="Accrued
Interest" type="AMT" />
    <field number="10089" name="LegAccruedInterestTotalAmt" description="Leg
Interest Amount" type="AMT" />
    <field number="10090" name="LegBenchmarkSpread" description="Basis Point/
Spread" type="PRICEOFFSET" />
    <field number="10091" name="LegCashOrdQty" description="Total Eligible Traded
Amount" type="QTY" />
    <field number="10092" name="SendingScope" description="" type="STRING" />
    <field number="10093" name="BreakContraAckStatus" description="" type="INT">
    <value enum="0" description="CONFIRMATION" />
    <value enum="1" description="CANCELLATION" />
</field>
<field number="10094" name="LegSign" description="" type="CHAR">
    <value enum="N" description="NEAR_LEG" />
    <value enum="F" description="FAR_LEG" />
    <value enum="O" description="MEANS_PER_LEGSIDE" />
</field>
    <field number="10095" name="LegCouponPaymentDateReset" description="Payment
date adjustment" type="CHAR">

```

```

    <value enum="0" description="PRECEDING_DAY" />
    <value enum="1" description="FOLLOWING_DAY" />
    <value enum="2" description="MODIFIED_FOLLOWING" />
    <value enum="3" description="MODIFIED_PROCEEDING" />
</field>
<field number="10096" name="LegCouponPaymentFrequency" description="Payment
frequency" type="STRING">
    <value enum="0" description="SEMI_ANNUALLY" />
    <value enum="1" description="ANNUALLY" />
    <value enum="2" description="MATURITY" />
    <value enum="3" description="MONTHLY" />
    <value enum="4" description="QUARTERLY" />
    <value enum="5" description="BIWEEKLY" />
    <value enum="6" description="WEEKLY" />
    <value enum="7" description="DAILY" />
    <value enum="7D" description="LEGSETTLTYPE_VALUE_7D" />
    <value enum="1W" description="LEGSETTLTYPE_VALUE_1W" />
    <value enum="2W" description="LEGSETTLTYPE_VALUE_2W" />
    <value enum="3W" description="LEGSETTLTYPE_VALUE_3W" />
    <value enum="1M" description="LEGSETTLTYPE_VALUE_1M" />
    <value enum="2M" description="LEGSETTLTYPE_VALUE_2M" />
    <value enum="3M" description="LEGSETTLTYPE_VALUE_3M" />
    <value enum="4M" description="LEGSETTLTYPE_VALUE_4M" />
    <value enum="5M" description="LEGSETTLTYPE_VALUE_5M" />
    <value enum="6M" description="LEGSETTLTYPE_VALUE_6M" />
    <value enum="7M" description="LEGSETTLTYPE_VALUE_7M" />
    <value enum="8M" description="LEGSETTLTYPE_VALUE_8M" />
    <value enum="9M" description="LEGSETTLTYPE_VALUE_9M" />
    <value enum="10M" description="LEGSETTLTYPE_VALUE_10M" />
    <value enum="11M" description="LEGSETTLTYPE_VALUE_11M" />
    <value enum="1Y" description="LEGSETTLTYPE_VALUE_1Y" />
    <value enum="2Y" description="LEGSETTLTYPE_VALUE_2Y" />
    <value enum="3Y" description="LEGSETTLTYPE_VALUE_3Y" />
    <value enum="4Y" description="LEGSETTLTYPE_VALUE_4Y" />
    <value enum="5Y" description="LEGSETTLTYPE_VALUE_5Y" />
    <value enum="6Y" description="LEGSETTLTYPE_VALUE_6Y" />
    <value enum="7Y" description="LEGSETTLTYPE_VALUE_7Y" />
    <value enum="8Y" description="LEGSETTLTYPE_VALUE_8Y" />
    <value enum="9Y" description="LEGSETTLTYPE_VALUE_9Y" />
    <value enum="10Y" description="LEGSETTLTYPE_VALUE_10Y" />
    <value enum="11Y" description="LEGSETTLTYPE_VALUE_11Y" />
    <value enum="12Y" description="LEGSETTLTYPE_VALUE_12Y" />
    <value enum="13Y" description="LEGSETTLTYPE_VALUE_13Y" />

```

```

<value enum="14Y" description="LEGSETTLTYPE_VALUE_14Y" />
<value enum="15Y" description="LEGSETTLTYPE_VALUE_15Y" />
<value enum="20Y" description="LEGSETTLTYPE_VALUE_20Y" />
<value enum="1D" description="LEGSETTLTYPE_VALUE_1D" />
<value enum="10D" description="LEGSETTLTYPE_VALUE_10D" />
<value enum="8" description="TEN_DAYS" />
<value enum="9" description="NINE_MONTHS" />
<value enum="10" description="IN_ADVANCE" />
</field>
<field number="10097" name="LegDayCount" description="Day count convention
0-Actual/Actual 1: (ACT/360) 2: 30/360" type="CHAR">
  <value enum="0" description="ACTUAL_DIVIDE_ACTUAL" />
  <value enum="1" description="ACT_DIVIDE_360" />
  <value enum="2" description="THIRTY_DIVIDE_360" />
  <value enum="3" description="A_DIVIDE_365" />
  <value enum="4" description="ISMA30_DIVIDE_360" />
  <value enum="5" description="A_DIVIDE_365F" />
</field>
<field number="10098" name="LegDeliveryType" description="Settlement Method"
type="INT">
  <value enum="0" description="DVP" />
  <value enum="4" description="PUD" />
  <value enum="5" description="DUP" />
  <value enum="6" description="BVB" />
  <value enum="7" description="NONE" />
  <value enum="8" description="BVBF" />
  <value enum="9" description="BVP" />
</field>
<field number="10099" name="StubRateFixedDate2" description="Stub Rate Fixed
Date" type="UTCDATEONLY" />
  <field number="10100" name="LegDirtyPrice" description="Dirty Price"
type="PRICE" />
    <field number="10101" name="LegFixingDateDayCount" description="first fixing
date day count&#xA;0 - Actual/Actual&#xA;1 - (ACT/360)&#xA;2 - 30/360" type="INT"
/>
      <field number="10102" name="LegFixingDateIndicator" description="first
fixing date indicator" type="INT">
        <value enum="0" description="EFFECTIVE_DATE_N" />
        <value enum="1" description="FIRST_PERIOD_START_DATE_N" />
      </field>
    <field number="10103" name="NetBasisChangePrevDay" description=""
type="PRICEOFFSET" />
      <field number="10104" name="LegNetBasisChangePrevDay" description=""

```



```

type="PRICEOFFSET" />
  <field number="10105" name="DealTransType" description="" type="CHAR">
    <value enum="0" description="DEAL_ENTRY" />
    <value enum="1" description="DEAL_MODIFICATION" />
    <value enum="2" description="DEAL_CANCELLATION" />
    <value enum="3" description="SUPPLEMENTARY_CONTRACT_MODIFICATION" />
    <value enum="4" description="SUPPLEMENTARY_CONTRACT_CANCELLATION" />
    <value enum="5" description="SUPPLEMENTARY_CONTRACT_CANCELLATION_BY_MSC"
  />
    <value enum="6"
description="SUPPLEMENTARY_CONTRACT_CANCELLATION_BY_TRADER" />
    <value enum="7" description="DEAL_MODIFICATION_ON_CDC_REJECTION" />
    <value enum="8" description="LIMIT_INFO_CHECK" />
    <value enum="9" description="LIMIT_INFO_CHECK_RESPONSE" />
    <value enum="A" description="EXECUTION_QUERY_RESPONSE" />
  </field>
  <field number="10106" name="LegInterestAccrualMethod" description="Interest
rate accrued method&#xA;0 - Simple&#xA;1 - Compound" type="CHAR">
    <value enum="0" description="SIMPLE" />
    <value enum="1" description="COMPOUND" />
  </field>
  <field number="10107" name="LegInterestAccrualResetDateAdjust"
description="Reset date adjustment &#xA;0 - Preceding Day&#xA;1 - Following
Day&#xA;2 - Modified Following;3- Modified Proceeding" type="CHAR">
    <value enum="0" description="PRECEDING_DAY" />
    <value enum="1" description="FOLLOWING_DAY" />
    <value enum="2" description="MODIFIED_FOLLOWING" />
    <value enum="3" description="MODIFIED_PROCEEDING" />
  </field>
  <field number="10108" name="LegInterestAccrualResetFrequency"
description="Reset frequency 0 - Semi-annually 1 - Annually 2 - Maturity 3 - Monthly
4 - Quarterly 5 - Bi-Weekly 6 - Weekly 7 -
Daily;7D;3M;6M;9M;1Y;2Y;3Y;4Y;5Y;6Y;7Y;8Y;9Y;10Y;11Y;12Y;13Y;14Y;15Y;20Y"
type="STRING">
    <value enum="0" description="SEMI_ANNUALLY" />
    <value enum="1" description="ANNUALLY" />
    <value enum="2" description="MATURITY" />
    <value enum="3" description="MONTHLY" />
    <value enum="4" description="QUARTERLY" />
    <value enum="5" description="BIWEEKLY" />
    <value enum="6" description="WEEKLY" />
    <value enum="7" description="DAILY" />
    <value enum="1D" description="LEGSETTLTYPE_VALUE_1D" />

```



```

<value enum="7D" description="LEGSETTLTYPE_VALUE_7D" />
<value enum="10D" description="LEGSETTLTYPE_VALUE_10D" />
<value enum="1W" description="LEGSETTLTYPE_VALUE_1W" />
<value enum="2W" description="LEGSETTLTYPE_VALUE_2W" />
<value enum="3W" description="LEGSETTLTYPE_VALUE_3W" />
<value enum="1M" description="LEGSETTLTYPE_VALUE_1M" />
<value enum="2M" description="LEGSETTLTYPE_VALUE_2M" />
<value enum="3M" description="LEGSETTLTYPE_VALUE_3M" />
<value enum="4M" description="LEGSETTLTYPE_VALUE_4M" />
<value enum="5M" description="LEGSETTLTYPE_VALUE_5M" />
<value enum="6M" description="LEGSETTLTYPE_VALUE_6M" />
<value enum="7M" description="LEGSETTLTYPE_VALUE_7M" />
<value enum="8M" description="LEGSETTLTYPE_VALUE_8M" />
<value enum="9M" description="LEGSETTLTYPE_VALUE_9M" />
<value enum="10M" description="LEGSETTLTYPE_VALUE_10M" />
<value enum="11M" description="LEGSETTLTYPE_VALUE_11M" />
<value enum="1Y" description="LEGSETTLTYPE_VALUE_1Y" />
<value enum="2Y" description="LEGSETTLTYPE_VALUE_2Y" />
<value enum="3Y" description="LEGSETTLTYPE_VALUE_3Y" />
<value enum="4Y" description="LEGSETTLTYPE_VALUE_4Y" />
<value enum="5Y" description="LEGSETTLTYPE_VALUE_5Y" />
<value enum="6Y" description="LEGSETTLTYPE_VALUE_6Y" />
<value enum="7Y" description="LEGSETTLTYPE_VALUE_7Y" />
<value enum="8Y" description="LEGSETTLTYPE_VALUE_8Y" />
<value enum="9Y" description="LEGSETTLTYPE_VALUE_9Y" />
<value enum="10Y" description="LEGSETTLTYPE_VALUE_10Y" />
<value enum="11Y" description="LEGSETTLTYPE_VALUE_11Y" />
<value enum="12Y" description="LEGSETTLTYPE_VALUE_12Y" />
<value enum="13Y" description="LEGSETTLTYPE_VALUE_13Y" />
<value enum="14Y" description="LEGSETTLTYPE_VALUE_14Y" />
<value enum="15Y" description="LEGSETTLTYPE_VALUE_15Y" />
<value enum="20Y" description="LEGSETTLTYPE_VALUE_20Y" />
</field>
<field number="10109" name="LegInterestResetCount" description="No of reset
in payment period" type="INT" />
<field number="10110" name="LegLastInterestResetDate" description="Last
reset date" type="UTCDATEONLY" />
<field number="10111" name="QueryResultType" description="1. Leg Information
Indicator (分期信息标识)&#xA;2 .Settlement status (结算状态)&#xA;3. Total Buy Single
order Limit (总单笔订单买入限额)&#xA;4. Total Sell Single order Limit (总单笔订单卖
出限额)&#xA;5. Total buy Cumulative order Limit (总累计订单买入限额)&#xA;6. Total sell
Cumulative order Limit (总累计订单卖出限额)&#xA;7. Utilized Buy Cumulative order
Limit (已用累计订单买入限额)&#xA;8. Utilized Sell Cumulative order Limit (已用累计

```

订单卖出限额)
9. Available Buy Cumulative order Limit (可用累计订单买入限额)
10. Available Sell Cumulative order Limit (可用累计订单卖出限额)
11. Number of Responses (报价回复笔数)
12. Number of Rejections (报价拒绝笔数)
13. Ratio of Rejections (拒绝率)
14. Ratio Type (比例类型)
15. Utilized Ratio (已用比例)
16. Ratio set (比例)" type="INT">

```

    <value enum="1" description="LEG_INFORMATION_INDICATOR" />
    <value enum="2" description="SETTLEMENT_STATUS" />
    <value enum="3" description="TOTAL_BUY_SINGLE_ORDER_LIMIT" />
    <value enum="4" description="TOTAL_SELL_SINGLE_ORDER_LIMIT" />
    <value enum="5" description="TOTAL_BUY_CUMULATIVE_ORDER_LIMIT" />
    <value enum="6" description="TOTAL_SELL_CUMULATIVE_ORDER_LIMIT" />
    <value enum="7" description="UTILIZED_BUY_CUMULATIVE_ORDER_LIMIT" />
    <value enum="8" description="UTILIZED_SELL_CUMULATIVE_ORDER_LIMIT" />
    <value enum="9" description="AVAILABLE_BUY_CUMULATIVE_ORDER_LIMIT" />
    <value enum="10" description="AVAILABLE_SELL_CUMULATIVE_ORDER_LIMIT" />
    <value enum="11" description="NUMBER_OF_RESPONSES" />
    <value enum="12" description="NUMBER_OF_REJECTIONS" />
    <value enum="13" description="RATIO_OF_REJECTIONS" />
    <value enum="14" description="RATIO_TYPE" />
    <value enum="15" description="UTILIZED_RATIO" />
    <value enum="16" description="RATIO_SET" />
</field>
    <field number="10112" name="LegLastSpotRate" description="(FX Market: Leg Spot Rate)" type="PRICE" />
    <field number="10113" name="DataDownloadStartTime" description="" type="UTCTIMESTAMP" />
    <field number="10114" name="DataDownloadEndTime" description="" type="UTCTIMESTAMP" />
    <field number="10115" name="LegLeaveQty" description="remaining amount" type="QTY" />
    <field number="10116" name="LegInterestFixDateAdjustment" description="Fixing Date Adjustment &#xA;0-V-0;1-V-1;2-V-2" type="CHAR">
        <value enum="0" description="V_0" />
        <value enum="1" description="V_1" />
        <value enum="2" description="V_2" />
    </field>
    <field number="10117" name="BreakContractRequestType" description="" type="INT">
        <value enum="0" description="NEW_CONTRACT_BREAK_REPORT" />
        <value enum="1" description="CONTRACT_BREAK_REPORT_CANCELLATION" />
    </field>
    <field number="10118" name="DrawRequestID" description="" type="STRING" />
    <field number="10119" name="LegMaxFloor" description="Maximum Display

```

```

Quantity(maximum display unit amount) " type="QTY" />
  <field number="10120" name="LegMaxQty" description="Maximum Trading Amount"
type="QTY" />
  <field number="10121" name="LegMinQty" description="Minimum Trading Amount"
type="QTY" />
  <field number="10122" name="LegMinTickSize" description="Tick Size for Trading
Amount (The counter party can deal only in multiples of the tick size defined)"
type="QTY" />
  <field number="10123" name="DrawAmt" description="" type="AMT" />
  <field number="10124" name="DrawRequestTime" description=""
type="UTCTIMESTAMP" />
  <field number="10125" name="DrawReqAckStatus" description="" type="INT">
  <value enum="0" description="RECEIVED_BUT_NOT_YET_PROCESSED" />
  <value enum="1" description="DO_NOT_KNOW_OR_REJECTED" />
</field>
  <field number="10126" name="DrawRespStatus" description="" type="INT">
  <value enum="0" description="REJECTED" />
  <value enum="1" description="ACCEPTED" />
  <value enum="2" description="APPLIED_DEFAULT" />
  <value enum="3" description="CANCELLED_BY_USER" />
</field>
  <field number="10127" name="DrawRespAckStatus" description="" type="INT">
  <value enum="0" description="ACCEPTED_SUCCESSFULLY" />
  <value enum="1" description="FAILED" />
</field>
  <field number="10128" name="MarginAccountAmt" description="" type="AMT" />
  <field number="10129" name="FrozenAmt" description="" type="AMT" />
  <field number="10130" name="PendingAmt" description="" type="AMT" />
  <field number="10131" name="AvailableAmt" description="" type="AMT" />
  <field number="10132" name="LegRiskOrderQty" description="FX Market: Leg Risk
Amount) " type="QTY" />
  <field number="10133" name="LegSettlCurrAmt" description="1st leg Settlement
Amount" type="AMT" />
  <field number="10134" name="LegSettlCurrAmt2" description="2nd Leg Settlement
Amount" type="AMT" />
  <field number="10135" name="LegSpotDate" description=" (FX Market: Leg Spot Date)
" type="UTCDATEONLY" />
  <field number="10136" name="LegStipulationType" description="Haircut
-Conversion Proportion (s) (%) Yield - Yield/ 1st Leg Yield Yield2 - 2nd Leg Yield
StopYield-STOPYIELD;StrikeYield-Strike Yield" type="STRING">
  <value enum="Haircut" description="CONVERSION_PROPORTION" />
  <value enum="Yield" description="YIELD_OR_1ST_LEG_YIELD" />
  <value enum="Yield2" description="SECOND_LEG_YIELD" />

```

```

    <value enum="StopYield" description="STOPYIELD" />
    <value enum="StrikeYield" description="STRIKE_YIELD" />
  </field>
  <field number="10137" name="LegStipulationValue" description="For Fixed
Income. Value of stipulation." type="PERCENTAGE" />
  <field number="10138" name="LegTradeCashAmt" description="Trade cash amount"
type="AMT" />
  <field number="10139" name="LegValidUntilTime" description="Quote Valid Time"
type="UTCTIMESTAMP" />
  <field number="10140" name="CollateralInfoChangeAckStatus" description=""
type="INT">
    <value enum="0" description="ACCEPTED_SUCCESSFULLY" />
    <value enum="1" description="FAILED" />
  </field>
  <field number="10141" name="NoTrdReports" description="" type="NUMBER" />
  <field number="10142" name="CollateralInfoChangeType" description=""
type="INT">
    <value enum="0" description="COLLATERAL_ACCOUNT_INFORMATION_CHANGE" />
    <value enum="1" description="DEAL_INFORMATION_CHANGE" />
    <value enum="2" description="PARTIES_INFORMATION_CHANGE" />
  </field>
  <field number="10143" name="LimitCategory" description="Limit Category 0 -
Daily 1 - Remaining balance 2-Cumulative limit" type="CHAR">
    <value enum="0" description="DAILY" />
    <value enum="1" description="REMAINING_BALANCE" />
    <value enum="2" description="CUMULATIVE_LIMIT" />
  </field>
  <field number="10144" name="LimitType" description="Limit Type&#xA;0 - Single
order limit&#xA;1 - Cumulative order limit" type="CHAR">
    <value enum="0" description="SINGLE_ORDER_LIMIT" />
    <value enum="1" description="CUMULATIVE_ORDER_LIMIT" />
  </field>
  <field number="10145" name="ListDate" description="Date instrument was issued.
For Fixed Income IOIs for new issues, specifies the issue date." type="UTCDATEONLY"
/>
  <field number="10146" name="MarginAMTRequired" description="" type="AMT" />
  <field number="10147" name="MarginSubmitAmt" description="" type="AMT" />
  <field number="10148" name="LastMarginSubmitDate" description=""
type="UTCTIMESTAMP" />
  <field number="10149" name="MarginAgency" description="Collateral Agency Name
0-CFETS; 1-CGSDTC; 2-Other ;3-All. This information needs to be entered in case
of cash only" type="CHAR">
    <value enum="0" description="CFETS" />

```

```

    <value enum="1" description="CGSDTC" />
    <value enum="2" description="OTHER" />
    <value enum="3" description="ALL" />
  </field>
  <field number="10150" name="MarginAMT" description="MarginTotal face value"
type="AMT" />
    <field number="10151" name="MarginCurrency" description="Margin Currency"
type="CURRENCY" />
    <field number="10152" name="MarginFaceValue" description="Margin face value"
type="AMT" />
    <field number="10153" name="MarginMaintainanceWay" description="Margin
Maintainance Way" type="STRING" />
    <field number="10154" name="MarginDirection" description="" type="CHAR">
      <value enum="1"
description="BUY_FIXED_RECEIVER_BENCHMARK_RECEIVER_TAKER_RECEIVE" />
      <value enum="4" description="SELL_FIXED_PAYER_BENCHMARK_PAYER_TAKER_PAY"
/>
    </field>
    <field number="10155" name="MarginPartyRole"
description="0-initiator&#xA;1-counterparty" type="INT">
      <value enum="0" description="INITIATOR" />
      <value enum="1" description="COUNTERPARTY" />
      <value enum="119"
description="BUYER_OR_BORROWER_OR_REVERSE_REPOER_OR_FIXED_PAYER_OR_BENCHMARK_
1_PAYER" />
      <value enum="120"
description="SELLER_OR_LENDER_OR_REPOER_OR_FIXED_RECEIVER_OR_BENCHMARK_1_RECE
IVER" />
    </field>
    <field number="10156" name="MarginRate" description="Securities Margin Rate"
type="PERCENTAGE" />
    <field number="10157" name="MarginReplacement" description="Margin
Replacement indicator" type="BOOLEAN">
      <value enum="Y" description="YES" />
      <value enum="N" description="NO" />
    </field>
    <field number="10158" name="MarginRequired" description="Collateral
Indicator" type="BOOLEAN">
      <value enum="Y" description="YES" />
      <value enum="N" description="NO" />
    </field>
    <field number="10159" name="MarginSecuritiesID" description="securities
margin code" type="STRING" />

```

```

    <field number="10160" name="MarginSecurityIDSource" description="securities
margin code source" type="STRING">
    <value enum="5" description="RIC_CODE" />
    <value enum="101" description="CFETS" />
    <value enum="102" description="CDC" />
    <value enum="103" description="USERDEFINED" />
</field>
    <field number="10161" name="MarginTotalAmt" description="Margin total amount"
type="AMT" />
    <field number="10162" name="MarginSubmitDate" description="Margin Submit
Date" type="UTCDATEONLY" />
    <field number="10163" name="NoMDTypes" description="" type="NUMINGROUP" />
    <field number="10164" name="MDType" description="Market Data Type"
type="CHAR">
    <value enum="0" description="ON_SHIBOR" />
    <value enum="1" description="SHIBOR_AVERAGES" />
    <value enum="6" description="BOND_INDEX" />
    <value enum="7" description="FR007_MOVING_AVERAGE_RATE" />
    <value enum="8" description="SHIBOR3M_IRS_CURVE" />
    <value enum="9" description="YIELD_CURVE" />
    <value enum="A" description="A_TIER_CLIENTS_FX_REAL_TIME_STATISTICS" />
    <value enum="B" description="B_TIER_CLIENTS_FX_TIME_LAG_STATISTICS" />
    <value enum="C" description="FX_MARKET_DATA_STATISTICS" />
    <value enum="D" description="FX_PRICE_DATA_UPDATE" />
    <value enum="E" description="FX_PRICE_DATA_SNAPSHOT" />
    <value enum="F" description="FX_PRICE_DATA_REFRESH" />
    <value enum="G" description="RMB_BROADCAST_MBO" />
    <value enum="H" description="RMB_BROADCAST_MBR" />
    <value enum="I" description="RMB_BROADCAST_DEAL_MARKET_INFORMATION" />
    <value enum="J" description="RMB_BROADCAST_SESSION_CONTROL" />
    <value enum="K" description="REPO_FIXING_RATE" />
    <value enum="L" description="BENCHMARK_REFERENCE" />
    <value enum="M" description="SHIBOR_TERM_INFORMATION" />
    <value enum="R" description="RMB_MARKET_DATA_STATISTICS" />
    <value enum="S" description="BENCHMARK_SAMPLE_DATA" />
    <value enum="T" description="VALUE_DATE_DATA" />
    <value enum="N" description="RMB_PRICE_DATA_UPDATE" />
</field>
    <field number="10165" name="NetChgPerPrevDay" description="Change over
Previous Day Closing Price" type="PERCENTAGE" />
    <field number="10166" name="LegNetChgPerPrevDay" description="Change over
Previous Day Closing Price" type="PERCENTAGE" />
    <field number="10167" name="NoQueryParam" description="" type="NUMINGROUP" />

```

```

<field number="10168" name="QueryRequestID" description="" type="STRING" />
<field number="10169" name="QueryParamType" description="1-Ratio Type 比例类
型 2-Settlement Status 结算状态 3-IRS Type 利率互换类型 4-Statistics Type 行情类别
5-Inquiry By 查询标准 6-QueryDirection 查询交易方向" type="CHAR">
  <value enum="1" description="RATIO_TYPE" />
  <value enum="2" description="SETTLEMENT_STATUS" />
  <value enum="3" description="IRS_TYPE" />
  <value enum="4" description="STATISTICS_TYPE" />
  <value enum="5" description="INQUIRY_BY" />
  <value enum="6" description="QUERYDIRECTION" />
</field>
<field number="10170" name="QueryParamValue" description="1. Single Bond
Outright Repo Ratio 单券种待返售余额比例 2. Multiple Bonds Ratio for Outright Repo
(待返售总余额比例) 3. Unilateral Buy Ratio 单机构单券种买入余额占该债券流通量的比例 4.
Unilateral Sell Ratio 单机构单券种卖出余额占该债券流通量的比例 5. Net Buying Ratio 净
买入总余额占实收资本(基金资产净值、净资产或营运资金)比例 6. Gross selling ratio 卖出总余
额占自营债券总余额比例 7. FX Query-Date 外汇成交查询-基于日期 8. FX Query-ExceID 外汇成
交查询-基于成交编号 9. 基准互换 10. 固定对浮动互换 11. 交易日 12. 结算日" type="STRING">
  <value enum="1" description="SINGLE_BOND_OUTRIGHT_REPO_RATIO" />
  <value enum="2" description="MULTIPLE_BONDS_RATIO_FOR_OUTRIGHT_REPO" />
  <value enum="3" description="UNILATERAL_BUY_RATIO" />
  <value enum="4" description="UNILATERAL_SELL_RATIO" />
  <value enum="5" description="NET_BUYING_RATIO" />
  <value enum="6" description="GROSS_SELLING_RATIO" />
  <value enum="7" description="FX_QUERY_BY_DATE" />
  <value enum="8" description="FX_QUERY_BY_EXCEID" />
  <value enum="9" description="FLOAT_RATE_TO_FLOAT_RATE" />
  <value enum="10" description="FIXED_RATE_TO_FLOAT_RATE" />
  <value enum="11" description="TRADE_DATE" />
  <value enum="12" description="SETTLEMENT_DATE" />
</field>
<field number="10171" name="DownloadRequestID" description="" type="STRING"
/>
<field number="10172" name="QueryResultValue" description="" type="STRING" />
<field number="10173" name="MarginSymbol" description="securities margin
name" type="STRING" />
<field number="10174" name="MarginTraced" description="Securities Margin
Traced Indicator" type="BOOLEAN">
  <value enum="Y" description="YES" />
  <value enum="N" description="NO" />
</field>
<field number="10175" name="MarginType" description="Margin Type
0-Bond;1-Cash;2-Bond and Cash;3-Bond Interest;4-Cash Interest;5-Bond and Cash

```



```

Interest" type="CHAR">
  <value enum="0" description="BOND" />
  <value enum="1" description="CASH" />
  <value enum="2" description="BOND_AND_CASH" />
  <value enum="3" description="BOND_INTEREST" />
  <value enum="4" description="CASH_INTEREST" />
  <value enum="5" description="BOND_AND_CASH_INTEREST" />
</field>
<field number="10176" name="MarketIndicator" description="Market"
type="STRING">
  <value enum="0" description="ALL" />
  <value enum="1" description="INTER_BANK_OFFERING" />
  <value enum="2" description="INTEREST_RATE_SWAP" />
  <value enum="3" description="FORWARD_RATE_AGREEMENT" />
  <value enum="4" description="CASH_BOND" />
  <value enum="5" description="BOND_FORWARD" />
  <value enum="6" description="ASSET_BACKED_SECURITY" />
  <value enum="7" description="ETFs" />
  <value enum="8" description="SECURITY_LENDING" />
  <value enum="9" description="COLLATERAL_REPO" />
  <value enum="10" description="OUTRIGHT_REPO" />
  <value enum="11" description="FXSWP" />
  <value enum="12" description="FXSPT" />
  <value enum="13" description="FXNDF" />
  <value enum="14" description="FXFOW" />
  <value enum="15" description="FXIRS" />
  <value enum="16" description="BENCHMARK" />
  <value enum="17" description="FXCRS" />
  <value enum="18" description="CRM" />
  <value enum="19" description="FXOPT" />
  <value enum="20" description="CNYDEPOSIT" />
  <value enum="21" description="FXDEPO" />
  <value enum="22" description="CNYLOAN" />
  <value enum="23" description="FIXED_DEPOSIT" />
  <value enum="24" description="REDEMPTORY_MONETARY_CAPITAL_FOR_SALE" />
</field>
<field number="10177" name="MarketStatReqID" description="Market
Statistics Request ID" type="STRING" />
  <field number="10178" name="NoLimitInfo" description="Number of LimitInfoGrp"
type="NUMINGROUP" />
  <field number="10179" name="MaxQty" description="Maximum Trading Amount"
type="AMT" />
  <field number="10180" name="MaxSingleDayLimit" description="Single Day

```



```

Maximum Net Limit set" type="AMT" />
  <field number="10181" name="MaxSingleDayLimitReminder" description="Single
Day Maximum Net Limit Reminder" type="BOOLEAN">
    <value enum="Y" description="YES" />
    <value enum="N" description="NO" />
  </field>
  <field number="10182" name="SecurityHoldingDays" description=""
type="NUMBER" />
  <field number="10183" name="DownloadParamValue" description=" 下载参数值&#xA;1-
固定-浮动&#xA;2-浮动-浮动&#xA;3-意向报价&#xA;4-对话报价&#xA;5-双向报价&#xA;6-点击成交
报价&#xA;7-限价报价&#xA;8-竞价订单&#xA;9-外汇日历史数据&#xA;10-外汇周历史数据&#xA;11-
外汇月历史数据" type="STRING">
    <value enum="1" description="FIXED_FLOATING" />
    <value enum="2" description="FLOATING_FLOATING" />
    <value enum="3" description="IOI_QUOTE" />
    <value enum="4" description="DIALOGUE_QUOTE" />
    <value enum="5" description="TWO_WAY_QUOTE" />
    <value enum="6" description="CLICK_AND_DEAL_QUOTE" />
    <value enum="7" description="LIMIT_QUOTE" />
    <value enum="8" description="MATCHING_ORDER" />
    <value enum="9" description="FX_DAILY_HISTORY_DATA" />
    <value enum="10" description="FX_WEEKLY_HISTORY_DATA" />
    <value enum="11" description="FX_MONTHLY_HISTORY_DATA" />
  </field>
  <field number="10184" name="MinFaceValueAmountTickSize" description="Tick
size for Total Face Value tick" type="AMT" />
  <field number="10185" name="NoLimits" description="Number of LimitDataGrp"
type="NUMINGROUP" />
  <field number="10186" name="MinSingleDayLimit" description="Single Day
Minimum Net Limit set" type="AMT" />
  <field number="10187" name="MinSingleDayLimitReminder" description="Single
Day Minimum Net Limit Reminder" type="BOOLEAN">
    <value enum="Y" description="YES" />
    <value enum="N" description="NO" />
  </field>
  <field number="10188" name="MinTickSize" description="Tick Size for Trading
Amount (The counter party can deal only in multiples of the tick size defined)"
type="AMT" />
  <field number="10189" name="AmendmentDate" description="Amendment Date"
type="UTCDATEONLY" />
  <field number="10190" name="NDFCurrency" description=" (FX Market: NDF Fixing
Text) " type="CURRENCY" />
  <field number="10191" name="NDFDate" description="FX Market: NDF Fixing Date"

```

```

type="UTCDATEONLY" />
  <field number="10192" name="NegotiationCount" description="Negotiation
Count" type="NUMBER" />
  <field number="10193" name="NewPassword" description="New Password"
type="STRING" />
  <field number="10194" name="NextCouponPaymentDate" description="Next coupon
payment date" type="UTCDATEONLY" />
  <field number="10195" name="NextSingleDayBuyLimit" description="Single Day
Limit available for Next Deal - Buy" type="AMT" />
  <field number="10196" name="NextSingleDaySellLimit" description="Single Day
Limit available for Next Deal - Sell" type="AMT" />
  <field number="10197" name="NextSystemSeqNo" description="Next system's
Segece Number" type="SEQNUM" />
  <field number="10198" name="NextUserSeqNo" description="Next User's Segece
Number" type="SEQNUM" />
  <field number="10199" name="NextValueDate" description="Next Value Date"
type="UTCDATEONLY" />
  <field number="10200" name="NoAccountInfo" description="Number of Account
Information" type="NUMINGROUP" />
  <field number="10201" name="NoConvertInfo" description="NoConvertInfo"
type="NUMINGROUP" />
  <field number="10202" name="NoCredRateAgencyInfo" description="Number of
Cred Rate Agency Information" type="NUMINGROUP" />
  <field number="10203" name="NoDeliveryType2Option" description=""
type="NUMINGROUP" />
  <field number="10204" name="NoDeliveryTypeOption" description="settlement
type option" type="NUMINGROUP" />
  <field number="10205" name="NoGroupsIDs" description="Repeating group below
should contain unique combinations of GroupID and GroupRole" type="NUMINGROUP"
/>
  <field number="10206" name="NoHistoryInfo" description="Number of history
Information" type="NUMINGROUP" />
  <field number="10207" name="NoInitialExchange" description="Number of Initial
Exchange Information" type="NUMINGROUP" />
  <field number="10208" name="NoLegStipulations" description="Number of
LegStipulations" type="NUMINGROUP" />
  <field number="10209" name="NoMarginAmt" description="Number of Margin Amount"
type="NUMINGROUP" />
  <field number="10210" name="NoMarginInfo" description="Number of Margin
Information" type="NUMINGROUP" />
  <field number="10211" name="NoMarginSecurities" description="Number of Margin
Securities" type="NUMINGROUP" />
  <field number="10212" name="NoMktStatEntries" description="Number of Market

```

```

Statistic Entries" type="NUMINGROUP" />
  <field number="10213" name="NoMktStatLegs" description="Number of Market
Statistic Legs" type="NUMINGROUP" />
  <field number="10214" name="NoQueryCondition" description="Number of Query
Condition" type="NUMINGROUP" />
  <field number="10215" name="NoRedemptionInfo" description="Redemption
details (Multiple records of redemption can be entered)" type="NUMINGROUP" />
  <field number="10216" name="NoReissueInfo" description="Number of Reissue
Informationh" type="NUMINGROUP" />
  <field number="10217" name="NoStub" description="Number of Stub"
type="NUMINGROUP" />
  <field number="10218" name="StubRequired" description="" type="BOOLEAN">
    <value enum="Y" description="YES" />
    <value enum="N" description="NO" />
  </field>
  <field number="10219" name="StubDescription" description="" type="STRING" />
  <field number="10220" name="ContinueBroadcast" description="" type="INT">
    <value enum="1" description="GET_BROADCAST_DATA_AFTER_RETRANSMISSION" />
    <value enum="0"
description="NOT_TO_GET_BROADCAST_DATA_AFTER_RETRANSMISSION" />
  </field>
  <field number="10221" name="OrderEntryTime" description="Order Entry Time"
type="UTCTIMESTAMP" />
  <field number="10222" name="OrdQtyResetAmount" description="Order Quantity
Reset Amount" type="AMT" />
  <field number="10223" name="OrdQtyResetDate" description="Order Quantity
Reset Date" type="UTCDATEONLY" />
  <field number="10224" name="OrdQtyResetFrequency" description="Order
Quantity Reset Frequency" type="CHAR" />
  <field number="10225" name="OrdQtyResetPercentage" description="Order
Quantity Reset Percentage" type="PERCENTAGE" />
  <field number="10226" name="OrdQtyResetRequired" description="Order Quantity
Reset Required" type="BOOLEAN">
    <value enum="Y" description="YES" />
    <value enum="N" description="NO" />
  </field>
  <field number="10227" name="OrdQtyResetType" description="Order Quantity
Reset Type&#xA;0 - Step up&#xA;1 - Step Down" type="INT">
    <value enum="0" description="STEP_UP" />
    <value enum="1" description="STEP_DOWN" />
  </field>
  <field number="10228" name="Originator" description="Originator"
type="STRING" />

```

```

    <field number="10229" name="PartyInfoType" description="Party Information
Type 1-Address book 2-Account info 3-member info 4-derivative limit institution
info; 5- Institution Group info; 6- Trader Privilege data" type="CHAR">
    <value enum="1" description="ADDRESS_BOOK" />
    <value enum="2" description="ACCOUNT_INFO" />
    <value enum="3" description="MEMBER_INFO" />
    <value enum="4" description="DERIVATIVE_LIMIT_INSTITUTION_INFO" />
    <value enum="5" description="INSTITUTION_GROUP_INFO" />
    <value enum="6" description="TRADER_PRIVILEGE_DATA" />
</field>
    <field number="10230" name="QueryStartTime" description="Query Start Time"
type="UTCTIMEONLY" />
    <field number="10231" name="QueryEndTime" description="Query End Time"
type="UTCTIMEONLY" />
    <field number="10232" name="CurrentNumReports" description="" type="INT" />
    <field number="10233" name="RecoveryAdjustment" description="" type="INT" />
    <field number="10234" name="RecoveryFromTime" description=""
type="UTCTIMESTAMP" />
    <field number="10235" name="UniqueOutputKey" description="" type="STRING" />
    <field number="10236" name="Price2" description="1st Leg clean price;2nd Leg
clean price" type="PRICE" />
    <field number="10237" name="PriceResetDate" description="Price Reset Date"
type="UTCDATEONLY" />
    <field number="10238" name="PriceSetDate" description="Price Set Date"
type="UTCDATEONLY" />
    <field number="10239" name="Principal" description="Principal" type="AMT" />
    <field number="10240" name="PrincipalPayFrequency" description="Principal
Payment Frequency&#xA;0 - Semi-annually&#xA;1 - Annually&#xA;2 - Maturity&#xA;3
- Monthly&#xA;4 - Quarterly&#xA;5 - Bi-Weekly&#xA;6 - Weekly" type="CHAR">
    <value enum="0" description="SEMI_ANNUALLY" />
    <value enum="1" description="ANNUALLY" />
    <value enum="2" description="MATURITY" />
    <value enum="3" description="MONTHLY" />
    <value enum="4" description="QUARTERLY" />
    <value enum="5" description="BIWEEKLY" />
    <value enum="6" description="WEEKLY" />
</field>
    <field number="10241" name="PrincipalPaymentRate" description="Principal
Payment Rate" type="PRICE" />
    <field number="10242" name="PriviledgeNo" description="Priviledge No"
type="STRING" />
    <field number="10243" name="TermToMaturity" description="Dx Mx Yx&#xA;Example:
Y3 M3 D2- 3 years 3 months 2 Days&#xA;D255 - 255 Days" type="MULTIPLEVALUESTRING"

```

```

/>
  <field number="10244" name="PutOrCallDueDate" description="Put/ call Due date"
type="UTCDATEONLY" />
  <field number="10245" name="PwdExpiryDate" description="PwdExpiryDate"
type="UTCDATEONLY" />
  <field number="10246" name="PwdExpiryFlag" description="PwdExpiryFlag"
type="BOOLEAN">
    <value enum="Y" description="YES" />
    <value enum="N" description="NO" />
  </field>
  <field number="10247" name="QueryEndDate" description="Date to"
type="UTCDATEONLY" />
  <field number="10248" name="QueryEndExecID" description="Query End Execution
ID" type="STRING" />
  <field number="10249" name="QueryEndSettlDate" description="Collateral
Settlement Date To" type="UTCDATEONLY" />
  <field number="10250" name="QueryExecType" description="QueryDeal
Status&#xA;0 - New&#xA;4 - Canceled&#xA;5 - Replaced&#xA;101 - Contingency&#xA;102
- All&#xA;103 - Purged" type="STRING">
    <value enum="0" description="NEW" />
    <value enum="4" description="CANCELED" />
    <value enum="5" description="REPLACED" />
    <value enum="101" description="CONTINGENCY" />
    <value enum="102" description="ALL" />
    <value enum="103" description="PURGED" />
  </field>
  <field number="10251" name="QueryMaxFwdTerm" description="Starting After To"
type="NUMBER" />
  <field number="10252" name="QueryMaxTerm" description="Term to" type="NUMBER"
/>
  <field number="10253" name="QueryMinFwdTerm" description="Starting After
From" type="NUMBER" />
  <field number="10254" name="QueryMinTerm" description="Term from"
type="NUMBER" />
  <field number="10255" name="QueryOrdStatus" description="0-Status for all
orders &#xA;&#xA;1-Status for orders which are not confirmed by the party
&#xA;&#xA;2-Status for all orders for the party &#xA;&#xA;3-Cancelled
&#xA;&#xA;4-Modified &#xA;&#xA;5-Partially Dealt &#xA;&#xA;6-Fully Dealt
&#xA;&#xA;7-Pending" type="CHAR">
    <value enum="0" description="STATUS_FOR_ALL_ORDERS" />
    <value enum="1"
description="STATUS_FOR_ORDERS_WHICH_ARE_NOT_CONFIRMED_BY_THE_PARTY" />
    <value enum="2" description="STATUS_FOR_ALL_ORDERS_FOR_THE_PARTY" />

```

```

    <value enum="3" description="CANCELLED" />
    <value enum="4" description="MODIFIED" />
    <value enum="5" description="PARTIALLY_DEALT" />
    <value enum="6" description="FULLY_DEALT" />
    <value enum="7" description="PENDING" />
</field>
<field number="10256" name="QueryPageNumber" description="Query Page
Number(FX Market: Indicate which page will be request.)" type="NUMBER" />
    <field number="10257" name="QueryPageSize" description="Query Page Size(FX
Market: The number of results in one page.)" type="NUMBER" />
    <field number="10258" name="QueryQuoteType" description="0-All(default)
1-List price(Negotiation) 2-Directional(Negotiation) 3-Dialogue(Negotiation)
4-Two way(Negotiation) 5-Limit Order(Click and Deal) 6-Non Designated Market
7-Designated Market Making Quote;8-Non Market Making Quote;9-Market Making
Quote;A-Market Making plus Non Market Making Quote;B-Click and Negotiate
Quote;C-Supplementary Clause;&lt;br&gt;Making Quote(Click and Deal) 7-Designated
Market Making Quote(Click and Deal) 8-Non Market Making Quote(Click and
Deal) ;9-Market Making Quote;A-Market Making plus Non Market Making Quote;"
type="CHAR">
    <value enum="0" description="ALL" />
    <value enum="1" description="LIST_PRICE" />
    <value enum="2" description="DIRECTIONAL" />
    <value enum="3" description="DIALOGUE" />
    <value enum="4" description="TWO_WAY" />
    <value enum="5" description="LIMIT_ORDER" />
    <value enum="6" description="NON_DESIGNATED_MARKET_MAKING_QUOTE" />
    <value enum="7" description="DESIGNATED_MARKET_MAKING_QUOTE" />
    <value enum="8" description="NON_MARKET_MAKING_QUOTE" />
    <value enum="9" description="MARKET_MAKING_QUOTE" />
    <value enum="A" description="MARKET_MAKING_PLUS_NON_MARKET_MAKING_QUOTE"
/>
    <value enum="B" description="CLICK_AND_NEGOTIATE_QUOTE" />
    <value enum="C" description="SUPPLEMENTARY_CLAUSE" />
</field>
<field number="10259" name="QueryRatingType" description="Inquiry Type&#xA;0
-Basic Information&#xA;1 -Historical information&#xA;2 -Credit Rating
information" type="CHAR">
    <value enum="0" description="BASIC_INFORMATION" />
    <value enum="1" description="HISTORICAL_INFORMATION" />
    <value enum="2" description="CREDIT_RATING_INFORMATION" />
</field>
<field number="10260" name="QueryRatioType" description="Ratio Type 0 -
Unilateral Buy Ratio 1 - Unilateral Sell Ratio 2 - Net Buying Ratio 3 -?Gross Selling

```

```

Ratio" type="CHAR">
  <value enum="0" description="UNILATERAL_BUY_RATIO" />
  <value enum="1" description="UNILATERAL_SELL_RATIO" />
  <value enum="2" description="NET_BUYING_RATIO" />
  <value enum="3" description="GROSS_SELLING_RATIO" />
</field>
<field number="10261" name="QuerySecurityMaturity" description="Days to
Maturity&#xA;Number of days to maturity &#xA;E. g : 345 days, 23 years 23
days&#xA;Days to maturity will be calculated from Effective From Date."
type="NUMBER" />
  <field number="10262" name="QuerySecurityType" description="0-Treasury
Bonds ;1-Policy Financial Bonds;2-Commercial Papers ;3-Subordinated Bonds ;4-Other
Financial Bonds ;5-Corporate Bonds;6-Central Bank Notes;7-International
Development Institution Bonds;8-Mixed Capital Bonds" type="CHAR">
  <value enum="0" description="TREASURY_BONDS" />
  <value enum="1" description="POLICY_FINANCIAL_BONDS" />
  <value enum="2" description="COMMERCIAL_PAPERS" />
  <value enum="3" description="SUBORDINATED_BONDS" />
  <value enum="4" description="OTHER_FINANCIAL_BONDS" />
  <value enum="5" description="CORPORATE_BONDS" />
  <value enum="6" description="CENTRAL_BANK_NOTES" />
  <value enum="7" description="INTERNATIONAL_DEVELOPMENT_INSTITUTION_BONDS"
/>
  <value enum="8" description="MIXED_CAPITAL_BONDS" />
</field>
<field number="10263" name="QuerySide" description="0 -All&#xA;1 -Buy&#xA;2
-Sell" type="CHAR">
  <value enum="0" description="ALL" />
  <value enum="1" description="BUY" />
  <value enum="2" description="SELL" />
</field>
<field number="10264" name="QueryStartDate" description="Date From"
type="UTCDATEONLY" />
  <field number="10265" name="QueryStartExecID" description="Query Start
Execution ID&#xA;(FX Market: Start GID)" type="STRING" />
  <field number="10266" name="QueryStartNumber" description="Query Start
Number&#xA;FX Market: Start number in results" type="NUMBER" />
  <field number="10267" name="QueryStartSettlDate" description="Collateral
Settlement Date From" type="UTCDATEONLY" />
  <field number="10268" name="QueryTradeMethod" description="0
-Negotiation&#xA;1 -Click & amp; Deal&#xA;2 -All (Default)" type="CHAR">
  <value enum="0" description="NEGOTIATION" />
  <value enum="1" description="CLICK_AND_DEAL" />

```



```

    <value enum="2" description="ALL" />
  </field>
  <field number="10269" name="QueryTradingProduct" description="0 - Standard
Product&#xA;1 - Combination" type="CHAR">
    <value enum="0" description="STANDARD_PRODUCT" />
    <value enum="1" description="COMBINATION" />
  </field>
  <field number="10270" name="QueryType" description="0-RMB deal inquiry( 本币
市场成交数据) 1-Self Quote Inquiry ( 本方询价报价查询) 2-Self Deal Details Inquiry ( 本
方成交明细查询) 3-Deal Details Inquiry by MBO User of Head Office( 分行成交明细查询)
4-Limit Inquiry ( 限额查询) 5-Settlement Inquiry ( 结算查询) 6-Announcement Inquiry
( 公告查询) 7-Click in Negotiate Reject Ratio Inquiry ( 一次确认报价拒绝率查询) 8-Ratio
Inquiry ( 比例查询) 9-Collateral Inquiry ( 保证品查询) 10-Benchmark Inquiry ( 基准利
率窗口) 11-Net Value Inquiry ( 基金净值查询) 12-Trading Fee Invoice Inquiry ( 缴费单
通知查询) 13-Trading Fee Inquiry ( 交易手续费查询) 14-ABS Information Inquiry ( 资产
支持证券信息查询) 15-FX Deal inquiry ( 外汇交易查询) 16-FX IRS or CRS inquiry ( 外汇
IRS/CRS查询) 17-FX Broadcast Request 18-FX Price Data Full Image Refresh Request
19-FX Historical Data Retransmission Request 20-RMB quote inquiry( 本币市场报价数
据) 21-Data center inquiry_database name 数据中心查询数据库名 22-Data center
inquiry_database schema name 数据中心查询数据库模式名 23-Data center inquiry_database
character sets value 数据中心查询数据库字符集 24-Data center inquiry_database time
数据中心查询数据库系统时间 25-Data center inquiry_database table name 数据中心查询表名
26-Data center inquiry_database view name 数据中心查询视图名 27-Data center
inquiry_database table DDL 数据中心查询表DDL 28-Data center inquiry_database view
DDL 数据中心查询视图DDL 29-Data center inquiry_database column data 数据中心查询列元数
据 30-Data center inquiry_database table data 数据中心查询表数据 31-未平仓合约查询 32-
计算代理查询 33-衍生品授信查询 34-基金净值总额提交查询 35-用户权限查询" type="INT">
    <value enum="0" description="RMB_DEAL_INQUIRY" />
    <value enum="1" description="SELF_QUOTE_INQUIRY" />
    <value enum="2" description="SELF_DEAL_DETAILS_INQUIRY" />
    <value enum="3"
description="DEAL_DETAILS_INQUIRY_BY_MBO_USER_OF_HEAD_OFFICE" />
    <value enum="4" description="LIMIT_INQUIRY" />
    <value enum="5" description="SETTLEMENT_INQUIRY" />
    <value enum="6" description="ANNOUNCEMENT_INQUIRY" />
    <value enum="7" description="CLICK_IN_NEGOTIATE_REJECT_RATIO_INQUIRY" />
    <value enum="8" description="RATIO_INQUIRY" />
    <value enum="9" description="COLLATERAL_INQUIRY" />
    <value enum="10" description="BENCHMARK_INQUIRY" />
    <value enum="11" description="NET_VALUE_INQUIRY" />
    <value enum="12" description="TRADING_FEE_INVOICE_INQUIRY" />
    <value enum="13" description="TRADING_FEE_INQUIRY" />
    <value enum="14" description="ABS_INFORMATION_INQUIRY" />

```



```

<value enum="15" description="FX_DEAL_INQUERY" />
<value enum="16" description="FX_IRS_OR_CRS_INQUERY" />
<value enum="17" description="FX_BROADCAST_REQUEST" />
<value enum="18" description="FX_PRICE_DATA_FULL_IMAGE_REFRESH_REQUEST" />
<value enum="19" description="FX_HISTORICAL_DATA_RETRANSMISSION_REQUEST"
/>
<value enum="21" description="DATA_CENTER_INQUERY_DATABASE_NAME" />
<value enum="22" description="DATA_CENTER_INQUERY_DATABASE_SCHEMA_NAME" />
<value enum="23"
description="DATA_CENTER_INQUERY_DATABASE_CHARACTER_SETS_VALUE" />
<value enum="24" description="DATA_CENTER_INQUERY_DATABASE_TIME" />
<value enum="25" description="DATA_CENTER_INQUERY_DATABASE_TABLE_NAME" />
<value enum="26" description="DATA_CENTER_INQUERY_DATABASE_VIEW_NAME" />
<value enum="27" description="DATA_CENTER_INQUERY_DATABASE_TABLE_DDL" />
<value enum="28" description="DATA_CENTER_INQUERY_DATABASE_VIEW_DDL" />
<value enum="29" description="DATA_CENTER_INQUERY_DATABASE_COLUMN_DATA" />
<value enum="30" description="DATA_CENTER_INQUERY_DATABASE_TABLE_DATA" />
<value enum="31" description="UNSETTLED_POSITIONS_INQUERY" />
<value enum="32" description="CALCULATION_AGENT_INQUERY" />
<value enum="33" description="DERIVATIVE_LIMIT_INQUERY" />
<value enum="34" description="NET_TOTAL_VALUE_OF_FUND_INQUERY" />
<value enum="35" description="TRADER_PRIVILEGE_DATA_INQUERY" />
</field>
<field number="10271" name="QuoteTime" description="Quote Time"
type="UTCTIMESTAMP" />
<field number="10272" name="QuoteTransType" description="N -New C -Cancel R
-Replace 1-Counter 2-Reject" type="CHAR">
<value enum="N" description="NEW" />
<value enum="C" description="CANCEL" />
<value enum="R" description="REPLACE" />
<value enum="1" description="COUNTER" />
<value enum="2" description="REJECT" />
</field>
<field number="10273" name="RedemptionDate" description="Date of Redemption"
type="UTCDATEONLY" />
<field number="10274" name="RedemptionFrequency" description="Frequency of
Redemption&#xA;0 - Semi-annually&#xA;1 - Annually&#xA;2 - Maturity&#xA;3 -
Monthly&#xA;4 - Quarterly&#xA;5 - Bi-Weekly&#xA;6 - Weekly" type="INT">
<value enum="0" description="SEMI_ANNUALLY" />
<value enum="1" description="ANNUALLY" />
<value enum="2" description="MATURITY" />
<value enum="3" description="MONTHLY" />
<value enum="4" description="QUARTERLY" />

```

```

    <value enum="5" description="BIWEEKLY" />
    <value enum="6" description="WEEKLY" />
</field>
<field number="10275" name="RedemptionIndicator" description="Redemption
Indicator" type="BOOLEAN">
    <value enum="Y" description="YES" />
    <value enum="N" description="NO" />
</field>
<field number="10276" name="RedemptionOfFaceValue" description="Redemption
Face Value" type="AMT" />
<field number="10277" name="RedemptionPx" description="Redemption Price"
type="PRICE" />
<field number="10278" name="RedemptionType" description="Redemption
Type&#xA;0 - Full&#xA;1 - Paritial Redemption" type="CHAR">
    <value enum="0" description="FULL" />
    <value enum="1" description="PARITIAL_REDEMPTION" />
</field>
<field number="10279" name="ReissueDate" description="Reissue Date"
type="UTCDATEONLY" />
<field number="10280" name="ReissueIndicator" description="Reissue
Indicator" type="BOOLEAN">
    <value enum="Y" description="YES" />
    <value enum="N" description="NO" />
</field>
<field number="10281" name="ReissueSize" description="Reissue Size"
type="AMT" />
<field number="10282" name="RemarkIndicator" description="Remark Indicator"
type="BOOLEAN">
    <value enum="Y" description="YES" />
    <value enum="N" description="NO" />
</field>
<field number="10283" name="ResetDateAdjustment" description="Reset Date
Adjustment&#xA;0 - Preceding Day&#xA;1 - Following Day&#xA;2 - Modified Following"
type="CHAR">
    <value enum="0" description="PRECEDING_DAY" />
    <value enum="1" description="FOLLOWING_DAY" />
    <value enum="2" description="MODIFIED_FOLLOWING" />
</field>
<field number="10284" name="RiskLastQty" description="FX Market: Risk Amount"
type="QTY" />
<field number="10286" name="SecurityTerm" description="Security Term"
type="NUMBER" />
<field number="10287" name="SegmentID" description="Market Indicator"

```

```

type="INT">
  <value enum="1" description="INTER_BANK_OFFERING" />
  <value enum="2" description="INTEREST_RATE_SWAP" />
  <value enum="3" description="FORWARD_RATE_AGREEMENT" />
  <value enum="4" description="CASH_BOND" />
  <value enum="5" description="BOND_FORWARD" />
  <value enum="6" description="ASSET_BACKED_SECURITY" />
  <value enum="7" description="ETFs" />
  <value enum="8" description="SECURITY_LENDING" />
  <value enum="9" description="COLLATERAL_REPO" />
  <value enum="10" description="OUTRIGHT_REPO" />
  <value enum="11" description="FXSWP" />
  <value enum="12" description="FXSPT" />
  <value enum="13" description="FXNDF" />
  <value enum="14" description="FXFOW" />
  <value enum="15" description="FXIRS" />
  <value enum="16" description="BENCHMARK" />
  <value enum="17" description="FXCRS" />
  <value enum="18" description="CRM" />
</field>
<field number="10288" name="LimitValue" description="Limit Value" type="AMT"
/>
  <field number="10289" name="SettlCurrAmt2" description="2nd Leg Settlement
Amount" type="AMT" />
  <field number="10290" name="SettlCurrency2" description="2nd leg settlement
currency (default is CNY)" type="CURRENCY" />
  <field number="10291" name="SettlDateAdjustment" description="Settlement
Date Adjustment &#xA;0 - Preceding Day&#xA;1 - Following Day&#xA;2 - Modified
Following" type="CHAR">
  <value enum="0" description="PRECEDING_DAY" />
  <value enum="1" description="FOLLOWING_DAY" />
  <value enum="2" description="MODIFIED_FOLLOWING" />
</field>
  <field number="10292" name="SettlResetDate" description="Settl Reset Date"
type="UTCDATEONLY" />
  <field number="10293" name="SingleDayUtilizeLimit" description="Utilize Net
Limit" type="AMT" />
  <field number="10294" name="SoftwareType" description="Software Type"
type="STRING" />
  <field number="10295" name="SplitIndicator" description="SplitIndicator"
type="BOOLEAN">
  <value enum="Y" description="YES" />
  <value enum="N" description="NO" />

```

```

</field>
<field number="10296" name="SpotDate" description="(FX Market: Spot Date)"
type="UTCDATEONLY" />
<field number="10297" name="StartingAfterDayCount" description="0 -
Actual/Actual&#xA;1 - (ACT/360)&#xA;2 - 30/360" type="CHAR">
<value enum="0" description="ACTUAL_DIVIDE_ACTUAL" />
<value enum="1" description="ACT_DIVIDE_360" />
<value enum="2" description="THIRTY_DIVIDE_360" />
</field>
<field number="10298" name="StubAmount" description="Stub Amount" type="AMT"
/>
<field number="10299" name="StubEndDate" description="Stub End Date"
type="UTCDATEONLY" />
<field number="10300" name="StubIndicator" description="Stub Indicator 0-No
Stub 1-Front Stub Indicator 2-Back Stub Indicator" type="INT">
<value enum="0" description="NO_STUB" />
<value enum="1" description="FRONT_STUB_INDICATOR" />
<value enum="2" description="BACK_STUB_INDICATOR" />
</field>
<field number="10301" name="StubInterestAmt" description="Stub Interest
Amount" type="AMT" />
<field number="10302" name="StubInterestPaymentDate" description="Stub
Interest Payment Date" type="UTCDATEONLY" />
<field number="10303" name="StubRateFixedDate" description="Stub Rate Fixed
Date" type="UTCDATEONLY" />
<field number="10304" name="StubStartDate" description="Stub Start Date"
type="UTCDATEONLY" />
<field number="10305" name="SubRedempIndicator" description="Sub-Redemp
Indicator&#xA;0 - Subscription&#xA;1 - Redemption" type="INT">
<value enum="0" description="SUBSCRIPTION" />
<value enum="1" description="REDEMPTION" />
</field>
<field number="10306" name="SubRedempMinUnit" description="Sub-Redemption
Minimum Unit" type="AMT" />
<field number="10307" name="SupplementaryClause" description="Supplimentary
Clause" type="STRING" />
<field number="10308" name="SysSeqNo" description="It's required field for
fixed income system e.g. NGCNYTS for Global message sequence number" type="SEQNUM"
/>
<field number="10309" name="TerminationTime" description="Termination Time"
type="UTCTIMESTAMP" />
<field number="10310" name="TotalPrincipal" description="Total Principal"
type="AMT" />

```

```

    <field number="10311" name="TotNumReportPages" description="The query results
will be grouped with fixed number. The field indicates that the total number of
groups. Trading system will send the first group of results one by one. If member
request next group, trading system will send the next group of results."
type="NUMBER" />
    <field number="10312" name="TradeCashAmt" description="Trade amount"
type="AMT" />
    <field number="10313" name="TradeEstimatedCashAmt" description="Trade
Estimated Cash Amount" type="AMT" />
    <field number="10314" name="TradeFwdDays" description="Trade Forward Days"
type="NUMBER" />
    <field number="10315" name="TradeInstrument" description="(FX Market:
Instrument):&#xA;1- FX.BILATERAL&#xA;2- FX.CROSS&#xA;3- FX.Anonymous&#xA;4-
IRDV.BILATERAL" type="CHAR">
        <value enum="1" description="FX_BILATERAL" />
        <value enum="2" description="FX_CROSS" />
        <value enum="3" description="FX_ANONYMOUS" />
        <value enum="4" description="IRDV_BILATERAL" />
    </field>
    <field number="10316" name="TradeLimitDays" description="calculate from valid
date" type="STRING" />
    <field number="10317" name="TradeMethod" description="Trading method"
type="INT">
        <value enum="0" description="ALL" />
        <value enum="1" description="NEGOTIATION" />
        <value enum="2" description="CLICK_AND_DEAL_LIMIT_ORDER_IN_FX_MARKET" />
        <value enum="3" description="MATCHING" />
        <value enum="4" description="REQUEST_FOR_QUOTE" />
        <value enum="5" description="ONE_CLICK" />
        <value enum="1" description="NEGOTIATION_NORMAL" />
        <value enum="2" description="ONE_CLICK_LIMIT_QUOTE" />
        <value enum="5" description="ONE_CLICK_NORMAL" />
        <value enum="6" description="CLICK_IN_NEGOTIATE_QUOTE" />
    </field>
    <field number="10318" name="TradeTime" description="Time the transaction
represented by this ExecutionReport occurred" type="UTCTIMEONLY" />
    <field number="10319" name="TradeType" description="Type of Trade 0-Designated
Market Making 1-Non Market Making 2-All(Market Making) 3-Non Designated Market
Making 4-Buy Market Making; 5-Sell Market Making;6-All Trade Types(market making
and non-market making);" type="INT">
        <value enum="0" description="DESIGNATED_MARKET_MAKING" />
        <value enum="1" description="NON_MARKET_MAKING" />
        <value enum="2" description="ALL" />

```

```

    <value enum="3" description="NON_DESIGNATED_MARKET_MAKING" />
    <value enum="4" description="BUY_MARKET_MAKING" />
    <value enum="5" description="SELL_MARKET_MAKING" />
    <value enum="6" description="ALL_TRADE_TYPES" />
</field>
<field number="10320" name="Turnover" description="TurnOver(Million Yuan)"
type="AMT" />
    <field number="10321" name="UnderlyingAccruedInterestAmt"
description="Accrued Interest Amount" type="AMT" />
    <field number="10322" name="UnderlyingAccruedInterestAmt2" description="2nd
Accrued Interest Amount" type="AMT" />
    <field number="10323" name="UnderlyingCashSubOpt" description="Cash
substitution Indicator" type="BOOLEAN">
        <value enum="Y" description="YES" />
        <value enum="N" description="NO" />
    </field>
    <field number="10324" name="UnderlyingCashSubPremRatio" description="Cash
Substitution Premium Ratio" type="PERCENTAGE" />
    <field number="10325" name="UnderlyingDirtyPrice2" description="Underlying
2nd-Leg Dirty Price" type="PRICE" />
    <field number="10326" name="UnderlyingFaceValue" description="Underlying
Face Value" type="AMT" />
    <field number="10327" name="UnderlyingFundManager" description="Underlying
Fund Manager" type="STRING" />
    <field number="10328" name="UnderlyingPx2" description="Underlying Price"
type="PRICE" />
    <field number="10329" name="UnderlyingRedemQty" description="Underlying
Redemption Quantity" type="QTY" />
    <field number="10330" name="UnderlyingSubQty" description="Underlying
Subscribe Quantity" type="AMT" />
    <field number="10331" name="UnderlyingTotalCashSubAmt"
description="Underlying Total Cash Substitution Amount" type="AMT" />
    <field number="10332" name="ProcessingStatus" description="" type="INT">
        <value enum="0" description="NOT_PROCESSED" />
        <value enum="1" description="FROZEN" />
        <value enum="2" description="PENDING" />
        <value enum="3" description="PROCESSED" />
        <value enum="4" description="DEAL_CANCELLATION" />
        <value enum="5" description="BREAK_CONTRACT_CANCELLATION" />
    </field>
    <field number="10333" name="UserSeqNo" description="User Message Sequence
Number" type="SEQNUM" />
    <field number="10334" name="ValidDays" description="Valid Days" type="NUMBER"

```

```

/>
  <field number="10335" name="ValidUntilDate" description="Valid Until Date"
type="UTCDATEONLY" />
  <field number="10336" name="VersionNo" description="Version No" type="STRING"
/>
  <field number="10337" name="MDSubType" description="" type="INT">
    <value enum="0" description="DEAL_MARKET_STATISTICS" />
    <value enum="1" description="DEAL_MARKET_STATISTICS_FLOATING_VS_FLOATING"
/>
    <value enum="2" description="DEAL_MARKET_STATISTICS_FIXED_VS_FLOATING" />
    <value enum="3" description="BOND_MARKET_STATISTICS" />
    <value enum="4" description="TWO_WAY_QUOTE_MARKET_STATISTICS" />
    <value enum="5"
description="TWO_WAY_QUOTE_MARKET_STATISTICS_FLOATING_VS_FLOATING" />
    <value enum="6"
description="TWO_WAY_QUOTE_MARKET_STATISTICS_FIXED_VS_FLOATING" />
    <value enum="7" description="TRADING_PRODUCT_MARKET_STATISTICS" />
    <value enum="8" description="REPO_RATE_STATISTICS" />
    <value enum="9" description="FIRST_LEG_CLEAN_PRICE_STATISTICS" />
    <value enum="10" description="SECOND_LEG_CLEAN_PRICE_STATISTICS" />
    <value enum="11" description="BOND_INDEX_DATA" />
    <value enum="13" description="DEAL_DATA_SAMPLE_OF_CLOSING_PRICE" />
    <value enum="14"
description="TWO_WAY_QUOTATION_SAMPLE_DATA_OF_CLOSING_PRICE" />
    <value enum="15"
description="REAL_TIME_QUOTATION_SAMPLE_DATA_OF_BENCHMARK_SECURITY" />
    <value enum="16"
description="REAL_TIME_YIELD_CURVE_DATA_OF_BENCHMARK_SECURITY" />
    <value enum="17" description="YIELD_CURVE_DATA_OF_ALL_SAMPLE_DATA" />
    <value enum="18"
description="THE_BEST_TWO_WAY_QUOTATION_DATA_OF_MARKET_MAKING_SECURITIES" />
    <value enum="19" description="BOND_INDEX_INTRA_DAY_DATA" />
    <value enum="20" description="FIXING_CURVE_DATA_OF_BENCHMARK_SECURITY" />
    <value enum="21"
description="THE_BEST_QUOTE_DATA_OF_BENCHMARK_SECURITY_FIXING_CURVE" />
  </field>
  <field number="10338" name="BuyTtlCmltveAmt" description="" type="AMT" />
  <field number="10339" name="SellTtlCmltveAmt" description="" type="AMT" />
  <field number="10340" name="MBRCmltveAmt" description="" type="AMT" />
  <field number="10341" name="OrderCount" description="" type="NUMBER" />
  <field number="10342" name="LastModifyTime" description=""
type="UTCTIMESTAMP" />
  <field number="10343" name="UpdatOperation" description="" type="INT">

```

```

    <value enum="0" description="NEWLY_ADDED" />
    <value enum="1" description="MODIFICATION" />
</field>
<field number="10344" name="CollateralType" description="" type="INT">
    <value enum="0" description="RMB_NEGOTIATION" />
    <value enum="1" description="MARGIN_REQUIRED" />
    <value enum="2" description="WARRANTER_REQUIRED" />
    <value enum="3" description="NON_MARGIN_REQUIRED" />
    <value enum="4" description="SUBORDINATED_DEBT" />
</field>
<field number="10345" name="RICName" description="" type="STRING" />
<field number="10346" name="CalculateAgency" description="Calculate Agency"
type="INT">
    <value enum="0" description="CFETS" />
    <value enum="1" description="SELLER" />
    <value enum="2" description="BUYER" />
    <value enum="3" description="BOTH" />
    <value enum="4" description="OTHER" />
</field>
<field number="10347" name="NoBusinessParams" description=""
type="NUMINGROUP" />
<field number="10348" name="NoSubParams" description="" type="NUMINGROUP" />
<field number="10349" name="BusinessParamType" description="" type="INT">
    <value enum="0" description="LOWEST_DEALT_PRICE" />
    <value enum="1" description="HIGHEST_DEALT_PRICE" />
    <value enum="2" description="HIGHEST_YIELD" />
    <value enum="3" description="LOWEST_YIELD" />
    <value enum="4" description="LOWEST_HAIRCUT_FOR_COLLATERALS" />
    <value enum="5" description="HIGHEST_HAIRCUT_FOR_COLLATERALS" />
    <value enum="6" description="SINGLE_SECURITY_RATIO" />
</field>
<field number="10350" name="BusinessParamValue" description="" type="FLOAT"
/>
<field number="10351" name="CashBondIndicator" description=""
type="BOOLEAN">
    <value enum="Y" description="YES" />
    <value enum="N" description="NO" />
</field>
<field number="10352" name="OptionEligibilityIndicator" description=""
type="BOOLEAN">
    <value enum="Y" description="YES" />
    <value enum="N" description="NO" />
</field>

```



```

    <field number="10353" name="OutrightRepoEligibilityIndicator" description=""
type="BOOLEAN">
    <value enum="Y" description="YES" />
    <value enum="N" description="NO" />
</field>
    <field number="10354" name="CollateralRepoEligibilityIndicator"
description="" type="BOOLEAN">
    <value enum="Y" description="YES" />
    <value enum="N" description="NO" />
</field>
    <field number="10355" name="TradeVolumeFlag"
description="TradeVolumeFlag&#xA;0-1M,1-3M,3-5M,5-10M,10-15M,15-20M,20-30M,30
-40M,40-50M,50M" type="CHAR">
    <value enum="0" description="ZERO_TO_ONE_MILLION" />
    <value enum="1" description="ONE_TO_THREE_MILLION" />
    <value enum="2" description="THREE_TO_FIVE_MILLION" />
    <value enum="3" description="FIVE_TO_TEN_MILLION" />
    <value enum="4" description="TEN_TO_15_MILLION" />
    <value enum="5" description="FIFTEEN_TO_TWENTY_MILLION" />
    <value enum="6" description="TWENTY_TO_THIRTY_MILLION" />
    <value enum="7" description="THIRTY_TO_FORTY_MILLION" />
    <value enum="8" description="FORTY_TO_FIFTY_MILLION" />
    <value enum="9" description="ABOVE_FIFTY_MILLION" />
</field>
    <field number="10356" name="BondForwardIndicator" description=""
type="BOOLEAN">
    <value enum="Y" description="YES" />
    <value enum="N" description="NO" />
</field>
    <field number="10357" name="SBLIndicator" description="" type="BOOLEAN">
    <value enum="Y" description="YES" />
    <value enum="N" description="NO" />
</field>
    <field number="10358" name="NoLiquidProvider" description=""
type="NUMINGROUP" />
    <field number="10359" name="LiquidProvider" description="" type="STRING" />
    <field number="10360" name="LiquidProviderType" description="Liquid Provider
Type &#xA;0-Bid;1-Ask" type="CHAR">
    <value enum="0" description="BID" />
    <value enum="1" description="ASK" />
</field>
    <field number="10361" name="TradeCashSpread" description="Cash Spread"
type="FLOAT" />

```

```

    <field number="10362" name="NoDownloadParam" description=""
type="NUMINGROUP" />
    <field number="10363" name="DownloadParamType" description="1-IRS Type
&#xA;2-Download Quote Type &#xA;3-FX History Data Download Type" type="INT">
    <value enum="1" description="IRS_TYPE" />
    <value enum="2" description="DOWNLOAD_QUOTE_TYPE" />
    <value enum="3" description="FX_HISTORY_DATA_DOWNLOAD_TYPE" />
</field>
    <field number="10364" name="NoDownloadedData" description=""
type="NUMINGROUP" />
    <field number="10365" name="DownloadedDataType" description="" type="INT" />
    <field number="10366" name="DownloadedDataValue" description=""
type="STRING" />
    <field number="10367" name="WhenIssuedIndicator" description=""
type="BOOLEAN">
    <value enum="Y" description="YES" />
    <value enum="N" description="NO" />
</field>
    <field number="10368" name="FundType" description="" type="INT">
    <value enum="0" description="SHORT_TERM_SECURITY_FUND" />
    <value enum="1" description="LONG_TERM_SECURITY_FUND" />
    <value enum="2" description="FUND_BASED_ON_TREASURY_BOND" />
    <value enum="3" description="FUND_BASED_ONCORPORATE_BOND" />
</field>
    <field number="10369" name="FeedBackIndicator" description="" type="INT">
    <value enum="0" description="NONE_FEEDBACK" />
    <value enum="1" description="SIMPLE_FEEDBACK" />
    <value enum="2" description="DETAILED_FEEDBACK" />
</field>
    <field number="10370" name="QueryDataBaseName" description="" type="STRING"
/>
    <field number="10371" name="QueryDBSchemaName" description="" type="STRING"
/>
    <field number="10372" name="QueryDBTableName" description="" type="STRING" />
    <field number="10373" name="QueryDBViewName" description="" type="STRING" />
    <field number="10374" name="QueryDBTableColName" description=""
type="STRING" />
    <field number="10375" name="DBDDLStatement" description="" type="STRING" />
    <field number="10376" name="DBSQLStatement" description="" type="STRING" />
    <field number="10377" name="QueryDBTimeFormat" description="" type="STRING"
/>
    <field number="10378" name="DBTime" description="" type="STRING" />
    <field number="10379" name="QueryRejectReason" description="" type="STRING"

```

```

/>
<field number="10380" name="NoDBNames" description="" type="NUMINGROUP" />
<field number="10381" name="DataBaseName" description="" type="STRING" />
<field number="10382" name="NoDBSchemas" description="" type="NUMINGROUP" />
<field number="10383" name="DBSchemaName" description="" type="STRING" />
<field number="10384" name="NoDBCharacterSets" description=""
type="NUMINGROUP" />
  <field number="10385" name="DBCharacterSetsName" description=""
type="STRING" />
  <field number="10386" name="NoDBTables" description="" type="NUMINGROUP" />
  <field number="10387" name="DBTableName" description="" type="STRING" />
  <field number="10388" name="DBTableComments" description="" type="STRING" />
  <field number="10389" name="NoDBTableColumns" description=""
type="NUMINGROUP" />
    <field number="10390" name="DBTableColName" description="" type="STRING" />
    <field number="10391" name="DBTableColType" description="" type="STRING" />
    <field number="10392" name="DBTableColNull" description="" type="BOOLEAN">
      <value enum="Y" description="YES" />
      <value enum="N" description="NO" />
    </field>
    <field number="10393" name="DBTableColDefault" description="" type="STRING"
/>
  <field number="10394" name="DBTableColPKey" description="" type="BOOLEAN">
    <value enum="Y" description="YES" />
    <value enum="N" description="NO" />
  </field>
  <field number="10395" name="DBTableColComments" description="" type="STRING"
/>
  <field number="10396" name="NoDBViews" description="" type="NUMINGROUP" />
  <field number="10397" name="DBViewName" description="" type="STRING" />
  <field number="10398" name="DBViewComments" description="" type="STRING" />
  <field number="10399" name="DBSQLResultCols" description="" type="STRING" />
  <field number="10400" name="DBCharacterSetsValue" description=""
type="STRING" />
    <field number="10401" name="FeesInfoType" description="" type="INT">
      <value enum="0" description="DETAILS" />
      <value enum="1" description="QUARTERLY" />
      <value enum="2" description="ANNUALLY" />
    </field>
    <field number="10402" name="MarketType" description="" type="INT">
      <value enum="0" description="FINANCE" />
      <value enum="1" description="TRADE" />
      <value enum="2" description="SECURITIES_BORROWING" />

```

```

    <value enum="3" description="DERIVATIVES" />
</field>
<field number="10403" name="TermType" description="" type="INT">
    <value enum="0" description="ONE_DAY_PRODUCT" />
    <value enum="1" description="TWO_DAYS_OR_ABOVE" />
</field>
<field number="10404" name="IncrementalTradeAmt" description="" type="AMT" />
<field number="10405" name="FeeRate" description="" type="PERCENTAGE" />
<field number="10406" name="FeePreferentialAmt" description="" type="AMT" />
<field number="10407" name="FeeActualAmt" description="" type="AMT" />
<field number="10408" name="PreferentialSpread" description=""
type="PERCENTAGE" />
<field number="10409" name="PreferentialType" description="" type="INT">
    <value enum="0" description="CBM_MARKET_MAKER" />
    <value enum="1" description="IBO_SHIBOR_MARKET_MAKER" />
</field>
<field number="10410" name="UpdateTime" description="" type="UTCTIMESTAMP" />
<field number="10411" name="UpdateUser" description="" type="STRING" />
<field number="10412" name="AccumulatedAmt" description="" type="AMT" />
<field number="10413" name="MDEntrySide" description="" type="CHAR">
    <value enum="1" description="BUY_OR_ASK" />
    <value enum="4" description="SELL_OR_BID" />
</field>
<field number="10414" name="DisplayType" description="" type="INT">
    <value enum="0" description="MARKET_BY_ORDER" />
    <value enum="1" description="MARKET_BY_PRICE" />
    <value enum="2" description="REAL_TIME_ORDER" />
    <value enum="3" description="CLICK_AND_DEAL_ORDERS_BOOK" />
    <value enum="4" description="MARKET_MAKER_ORDERS_BOOK" />
</field>
<field number="10415" name="LegTtlClmtveAmt" description="" type="AMT" />
<field number="10416" name="NoLegOrders" description="" type="NUMINGROUP" />
<field number="10417" name="LegOrderCount" description="" type="NUMBER" />
<field number="10418" name="LegClmtveAmt" description="" type="AMT" />
<field number="10419" name="PartyInfoAckStatus" description="" type="INT">
    <value enum="0" description="ACCEPTED" />
    <value enum="1" description="REJECTED" />
</field>
<field number="10420" name="AutoQuoteIndicator" description=""
type="BOOLEAN">
    <value enum="Y" description="YES" />
    <value enum="N" description="NO" />
</field>

```

```

<field number="10421" name="VolumeMax" description="" type="QTY" />
<field number="10422" name="VolumeMin" description="" type="QTY" />
<field number="10423" name="AskPriceMax" description="" type="PRICE" />
<field number="10424" name="AskPriceMin" description="" type="PRICE" />
<field number="10425" name="BidPriceMax" description="" type="PRICE" />
<field number="10426" name="BidPriceMin" description="" type="PRICE" />
<field number="10427" name="IssueTime" description="" type="UTCTIMESTAMP" />
<field number="10428" name="ReasonType" description="" type="CHAR">
  <value enum="1" description="FORMAT_INVALID" />
  <value enum="2" description="MISSING_TIERS" />
  <value enum="3" description="NOT_SUBSCRIBED" />
  <value enum="4" description="PRICE_INCORRECT_DECIMAL_PLACES" />
  <value enum="5" description="PRICE_INVALID" />
  <value enum="6" description="PRICE_INVERTED" />
  <value enum="7" description="PRICE_OUT_OF_BAND" />
  <value enum="8" description="SPOT_VOL_OVERLAP" />
  <value enum="9" description="COUNTERPART_ERROR" />
  <value enum="A" description="CREDIT_ERROR" />
  <value enum="B" description="DEAL_DATA_ERROR" />
  <value enum="C" description="INTERNAL_ERROR" />
  <value enum="D" description="UNKNOWN_DEAL_ERROR" />
  <value enum="E" description="USER_DATA_ERROR" />
</field>
<field number="10429" name="DecimalPlaces" description="" type="INT" />
<field number="10430" name="FWDecimalPlaces" description="" type="INT" />
<field number="10431" name="QuoteRequestType" description="" type="CHAR">
  <value enum="1" description="SUBSCRIPTION" />
  <value enum="2" description="UNSUBSCRIPTION" />
</field>
<field number="10432" name="LogoutStatus" description="" type="INT">
  <value enum="1" description="ACCOUNT_DISABLED" />
  <value enum="2" description="ACCOUNT_IN_USE" />
  <value enum="3" description="ACCOUNT_LOCKED" />
  <value enum="4" description="BAD_LOGIN" />
  <value enum="5" description="CONNECTION_ERROR" />
  <value enum="6" description="DATABASE_ERROR" />
  <value enum="7" description="HARDWARE_TOKEN_FAILED" />
  <value enum="8" description="INVALID_CERTIFICATE" />
  <value enum="9" description="INVALID_CUSTOMER_ID" />
  <value enum="10" description="INVALID_USERSET_MEMBERSHIP" />
  <value enum="11" description="INVALID_VERSION" />
  <value enum="12" description="LICENCE_INVALID" />
  <value enum="13" description="NEW_PASSWORD_ALREADY_USED" />

```

```

    <value enum="14" description="NEW_PASSWORD_INVALID" />
    <value enum="15" description="NO_ERROR" />
    <value enum="16" description="NOT_CONNECTED" />
    <value enum="17" description="PASSWORD_EXPIRED" />
    <value enum="18" description="PASSWORD_RESET_REQUIRED" />
    <value enum="19" description="PASSWORD_UNCONFIRMED" />
    <value enum="20" description="PROCESSING_DATE_ROLLOVER" />
    <value enum="21" description="RESET_BY_PEER" />
    <value enum="22" description="RESOURCE_UNAVAILABLE" />
    <value enum="23" description="UNRECOGNISED_IP_ADDRESS" />
    <value enum="24" description="USER_LICENCE_LIMIT_EXCEEDED" />
</field>
<field number="10433" name="BenchmarkEffectiveDate" description=""
type="UTCDATEONLY" />
<field number="10434" name="Description" description="" type="STRING" />
<field number="10435" name="NoIndexes" description="" type="NUMINGROUP" />
<field number="10436" name="IndexType" description="" type="INT">
    <value enum="0" description="OPENING_PRICE" />
    <value enum="1" description="CLOSING_PRICE" />
    <value enum="2" description="HIGHEST_PRICE" />
    <value enum="3" description="LOWEST_PRICE" />
    <value enum="4" description="TRADE_VOLUME" />
    <value enum="5" description="TRADE_AMOUNT" />
</field>
<field number="10437" name="IndexValue" description="" type="PRICE" />
<field number="10438" name="TermFloorLimit" description="" type="STRING" />
<field number="10439" name="TermUpperLimit" description="" type="STRING" />
<field number="10440" name="RepeatingCaculateIndicator" description=""
type="BOOLEAN">
    <value enum="Y" description="YES" />
    <value enum="N" description="NO" />
</field>
<field number="10441" name="WeightedType" description="weighted type"
type="INT">
    <value enum="0" description="ARITHMETIC_WEIGHTED_AVERAGE" />
    <value enum="1" description="INDEX_WEIGHTED_AVERAGE" />
</field>
<field number="10442" name="NoYields" description="" type="NUMINGROUP" />
<field number="10443" name="YieldTerm" description="" type="FLOAT" />
<field number="10444" name="NoCurves" description="" type="NUMINGROUP" />
<field number="10445" name="CurveType" description="Curve type" type="INT">
    <value enum="0" description="ASK" />
    <value enum="1" description="BID" />

```

```

<value enum="2" description="COMPREHENSIVE_YIELD" />
<value enum="3" description="MIDDLE_PRICE" />
<value enum="4" description="FORWARD_YIELD" />
<value enum="5" description="SPOT_YIELD" />
<value enum="6" description="SPOT_ASK_YIELD" />
<value enum="7" description="SPOT_BID_YIELD" />
<value enum="8" description="SPOT_MIDDLE_YIELD" />
<value enum="9" description="MATURE_ASK_YIELD" />
<value enum="10" description="MATURE_BID_YIELD" />
<value enum="11" description="MATURE_MIDDLE_YIELD" />
<value enum="101" description="DEAL_CURVE_DATA" />
<value enum="102" description="QUOTE_CURVE_DATA" />
<value enum="103" description="BROKER_CURVE_DATA" />
<value enum="104" description="TRADING_PLATFORM_CURVE_DATA" />
<value enum="105" description="CURRENT_QUOTE_CURVE_DATA" />
<value enum="106" description="HISTORY_QUOTE_CURVE_DATA" />
<value enum="1061" description="PREVIOUS_CLOSE_PRICE_CURVE_DATA" />
<value enum="107" description="FIXING_REPO_RATE_DATA" />
<value enum="108" description="SHIBOR_DATA" />
<value enum="109" description="MANUAL_INPUT_DATA" />
<value enum="110" description="SUPPLEMENT_FOR_NEW_TERM_DATA" />
<value enum="111" description="NONE" />
</field>
<field number="10446" name="YieldPx" description="" type="PRICE" />
<field number="10447" name="MDTypeDescription" description="" type="STRING"
/>
<field number="10448" name="BenchmarkState" description="" type="INT">
  <value enum="0" description="ACTIVE" />
  <value enum="1" description="INACTIVE" />
</field>
<field number="10449" name="BenchmarkPublishFlag" description="" type="INT">
  <value enum="0" description="NO" />
  <value enum="1" description="YES" />
</field>
<field number="10450" name="BreakContractRequestID" description="Unique
identifier of BreakContractRequest" type="STRING" />
  <field number="10451" name="CollateralInfoChangeID" description="Unique
identifier of CollateralInfoChange" type="STRING" />
  <field number="10452" name="SignatureMethod" description="" type="STRING" />
  <field number="10453" name="NewMarginSubmitDate" description=""
type="UTCDATEONLY" />
  <field number="10454" name="ExecCxlID" description="" type="STRING" />
  <field number="10455" name="ExecCxlTime" description="" type="UTCTIMESTAMP"

```



```

/>
  <field number="10456" name="LegPrincipal" description="principal" type="AMT"
/>
  <field number="10457" name="LegTotalPrincipal" description="Total Principal"
type="AMT" />
  <field number="10458" name="LegLastQty" description="Traded
Quantity&#xA;(e.g. shares) bought/sold on this (last) fill" type="QTY" />
  <field number="10459" name="LegDeliveryType2" description="2nd leg Settlement
method" type="INT">
    <value enum="0" description="DVP" />
    <value enum="4" description="PUD" />
    <value enum="5" description="DUP" />
    <value enum="6" description="BVB" />
    <value enum="7" description="NONE" />
    <value enum="8" description="BVBF" />
    <value enum="9" description="BVP" />
  </field>
  <field number="10460" name="UnderlyingIssueSize" description="Underlying
issue size" type="AMT" />
  <field number="10461" name="MarginChangeIndicator" description="Margin
change indicator" type="BOOLEAN">
    <value enum="Y" description="YES" />
    <value enum="N" description="NO" />
  </field>
  <field number="10462" name="DelayPeriod" description="" type="STRING" />
  <field number="10463" name="TrdContrRepID" description="Trade Control Report
ID" type="STRING" />
  <field number="10464" name="MarketDataCancel" description="Markert Data
Cancle" type="BOOLEAN">
    <value enum="Y" description="YES" />
    <value enum="N" description="NO" />
  </field>
  <field number="10465" name="DataCategoryIndicator" description="Data
category Indicator" type="INT">
    <value enum="0" description="SELF_DATA" />
    <value enum="1" description="MARKET_DATA" />
    <value enum="2" description="RELATED_INSTITUTION_DATA" />
    <value enum="3" description="BASIC_DATA" />
  </field>
  <field number="10466" name="MMETSId" description="" type="STRING" />
  <field number="10467" name="InCompetition" description="" type="BOOLEAN">
    <value enum="Y" description="YES" />
    <value enum="N" description="NO" />

```



```

</field>
<field number="10468" name="QuoteWindow" description="" type="INT" />
<field number="10469" name="RiskCurrency" description="" type="STRING" />
<field number="10470" name="TimeToLive" description="" type="INT" />
<field number="10471" name="Reference" description="" type="STRING" />
<field number="10472" name="ForwardScaleDecimalPlaces" description=""
type="INT" />
<field number="10473" name="BaseAmountDPS" description="" type="INT" />
<field number="10474" name="TermAmountDPS" description="" type="INT" />
<field number="10475" name="RoundDownCurrencies" description=""
type="STRING" />
<field number="10476" name="AutoTraderPickup" description="" type="BOOLEAN">
  <value enum="Y" description="YES" />
  <value enum="N" description="NO" />
</field>
<field number="10477" name="AutoTradable" description="" type="BOOLEAN">
  <value enum="Y" description="YES" />
  <value enum="N" description="NO" />
</field>
<field number="10478" name="ForwardPoints" description="" type="PRICEOFFSET"
/>
<field number="10479" name="LegForwardPoints" description=""
type="PRICEOFFSET" />
<field number="10480" name="SpotRate" description="" type="PRICE" />
<field number="10481" name="LegSpotRate" description="" type="PRICE" />
<field number="10482" name="MRFQId" description="" type="STRING" />
<field number="10483" name="SnapshotInterval" description="FX Snapshot
interval" type="STRING" />
<field number="10484" name="ShiborAveType" description="Shibor Value Average
Type" type="STRING" />
<field number="10485" name="EntitySerialNum" description="" type="STRING" />
<field number="10486" name="PaySettledCount" description="" type="INT" />
<field number="10487" name="PayTotalSettlAmt" description="" type="AMT" />
<field number="10488" name="RecSettledCount" description="" type="INT" />
<field number="10489" name="RecTotalSettlAmt" description="" type="AMT" />
<field number="10490" name="SettlReportType" description="" type="INT">
  <value enum="0" description="PUSHED_REPORT" />
  <value enum="1" description="RETURNED_REPORT" />
</field>
<field number="10491" name="SettlReportStatus" description="settlement
report status" type="INT">
  <value enum="0" description="NORMAL" />
  <value enum="1" description="NO_RECORD" />

```

```

    <value enum="2" description="WRONG_CLEARING_DATE" />
    <value enum="3" description="OTHER_ERRORS" />
    <value enum="4" description="QUERY_FACTORS_LOST" />
    <value enum="5" description="USER_ID_OR_PASSWORD_ERROR" />
    <value enum="6" description="NO_INSTITUTION_MATCHED" />
</field>
<field number="10492" name="ParentOrderID" description="" type="STRING" />
<field number="10493" name="LimitOrderSubType" description="" type="INT" />
<field number="10494" name="CorrespStrdSecurityTerm"
description="corresponding standard security term" type="STRING" />
    <field number="10495" name="DistrictBelongedTo" description="The district
that member belongs to" type="STRING" />
    <field number="10496" name="NoCurrencies" description="" type="NUMINGROUP" />
    <field number="10497" name="BuyWeightedPX" description="The weight Price of
buy" type="PRICE" />
    <field number="10498" name="SellWeightedPX" description="The weight price of
Sell" type="PRICE" />
    <field number="10499" name="NoCurrPairs" description="The number of currency
pairs" type="NUMINGROUP" />
    <field number="10500" name="NoSettlExecs" description="The number of
execution" type="NUMINGROUP" />
    <field number="10501" name="BuyDealCCYAmt" description="Buy deal currency
amount" type="AMT" />
    <field number="10502" name="SellContraCCYAmt" description="Sell Contra
Currency Amount" type="AMT" />
    <field number="10503" name="SellDealCCYAmt" description="Sell deal currency
amount" type="AMT" />
    <field number="10504" name="BuyContraCCYAmt" description="Buy Contra Currency
Amount" type="AMT" />
    <field number="10505" name="CollDPInquiryType" description="" type="INT">
    <value enum="0" description="DRAW_COLLATERAL_DETAIL_REPORT" />
    <value enum="1" description="PAY_COLLATERAL_DETAIL_REPORT" />
    <value enum="2" description="COLLTERAL_TRANSFER_REPORT" />
</field>
    <field number="10506" name="MarginIndicator" description="" type="INT">
    <value enum="0"
description="THE_LEAST_MARGIN_CASH_DIVIDE_MARGIN_SECURITY_REQUIRED_OR_FIXED_T
ERM_ACCOUNT" />
    <value enum="1"
description="THE_TRANSFORMABLE_MARGIN_CASH_DIVIDE_MARGIN_SECURITY_OR_CURRENT_
ACCOUNT" />
    <value enum="2" description="THE_LEAST_MARGIN_SECURITY" />
</field>

```

```

    <field number="10507" name="SettlLmtAmtCurrency" description="Settlement
limit Amount Currency" type="CURRENCY" />
    <field number="10508" name="SettlLimitAmt" description="Settlement Limit
Amount" type="AMT" />
    <field number="10509" name="CnvtIntoCurrency" description="Convert into
currency" type="CURRENCY" />
    <field number="10510" name="SupplementalDate" description="Supplemental
date" type="UTCDATEONLY" />
    <field number="10511" name="NoConverts" description="The number of convert
information" type="NUMINGROUP" />
    <field number="10512" name="CnvtIntoAmt" description="" type="AMT" />
    <field number="10513" name="LeastLimitReqedAmt" description="the least limit
requested amount" type="AMT" />
    <field number="10514" name="SettlExecStatus" description="Settlement
Confirmation Status" type="INT">
        <value enum="0" description="CORRECT" />
        <value enum="1" description="MORE_THAN_EXECTION_AMOUNT" />
        <value enum="2" description="WRONG_EXECTION_AMOUNT" />
        <value enum="3" description="LESS_THAN_EXECTION_AMOUNT" />
        <value enum="4" description="WRONG_CALCULATION_AMOUNT" />
        <value enum="5" description="OTHER" />
    </field>
    <field number="10515" name="MarginMktValue" description="Market Value"
type="AMT" />
    <field number="10516" name="CurrentFXRate" description="current FX rate"
type="PRICE" />
    <field number="10517" name="CollDPRptStatus" description="" type="INT">
        <value enum="0" description="NORMAL" />
        <value enum="1" description="NO_RECORD" />
        <value enum="2" description="WRONG_CLEARING_DATE" />
        <value enum="3" description="OTHER_ERRORS" />
    </field>
    <field number="10518" name="ChangedAmt" description="Changed amount"
type="AMT" />
    <field number="10519" name="CollDPInquiryID" description="The request ID of
collateral draw or collateral pay report" type="STRING" />
    <field number="10520" name="CollDPDtlRptID" description="The serial number of
Draw collaterals report or Pay collateral report." type="STRING" />
    <field number="10521" name="UpdatedSecurityType" description="The type of
Security Updated" type="INT">
        <value enum="0" description="MARGIN_SECURITY_UPDATE" />
        <value enum="1" description="MARKET_MAKING_SECURITY_UPDATE" />
    </field>

```

```

    <field number="10522" name="PaymentRoute" description="The Payment Route"
type="INT">
    <value enum="0" description="TRANSFER_IN_THE_SAME_BANK" />
    <value enum="1" description="CHINA_FOREIGN_EXCHANGE_PAYMENT_SYSTEM" />
    <value enum="2" description="CORRESPONDENT_BANK" />
    <value enum="3" description="CHINA_RMB_HIGH_VALUE_PAYMENT_SYSTEM" />
</field>
<field number="10523" name="CollDetailRepID" description="" type="STRING" />
<field number="10524" name="NoSecuritiesInsts" description="The number of
securities interest" type="NUMINGROUP" />
    <field number="10525" name="MarginInstAmt" description="" type="AMT" />
    <field number="10526" name="NoCashInsts" description="" type="NUMINGROUP" />
    <field number="10527" name="NoMarginExecs" description="" type="NUMINGROUP"
/>
    <field number="10528" name="MarginDebitAmt" description="The Debit amount"
type="AMT" />
    <field number="10529" name="MarginCreditAmt" description="The credit amount"
type="AMT" />
    <field number="10530" name="MarginDebitTtlAmt" description="" type="AMT" />
    <field number="10531" name="MarginCreditTtlAmt" description="" type="AMT" />
    <field number="10532" name="PartyInfoID" description="" type="STRING" />
    <field number="10533" name="NoMarginDPs" description="the repeating number of
repeating group &lt;span
style="font-size:10pt;line-height:119%;font-family:'Times New
Roman'&gt;&lt;strong&gt;MarginDPDtlGrp.&lt;/strong&gt;&lt;/span&gt;"
type="NUMINGROUP" />
    <field number="10534" name="DPReportType" description="Draw collaterals or Pay
collaterals." type="INT">
    <value enum="0" description="DRAW_COLLATERALS_DATA" />
    <value enum="1" description="PAY_COLLATERALS_DATA" />
    <value enum="2" description="COLLATERAL_TRANSFER_REPORT" />
</field>
<field number="10535" name="RelatedReference" description="" type="STRING" />
<field number="10536" name="InterestRecDate" description=""
type="UTCDATEONLY" />
<field number="10537" name="CnvtIntoAmtType" description="" type="INT">
    <value enum="0" description="SUPPLEMENTAL_MARGIN" />
    <value enum="1" description="MARGIN_CASH_DIVIDE_MARGIN_SECURITY" />
</field>
<field number="10538" name="CurrNumOfTot" description="" type="NUMBER" />
<field number="10539" name="SecurityListReqID" description="the unique ID of
Security List request" type="STRING" />
    <field number="10540" name="CollInquiryType" description="the type of query

```

```

detail" type="INT">
  <value enum="0" description="SETTLEMENT_REPORT_INQUIRY" />
  <value enum="1" description="INTEREST_REPORT_INQUIRY" />
  <value enum="2"
description="MARKET_VALUE_BALANCE_AND_CHANGES_INQUIRY_OF_MARGIN_SECURITY" />
  <value enum="3"
description="MARKET_VALUE_BALANCE_AND_CHANGES_INQUIRY_OF_MARGIN_CASH" />
  <value enum="4" description="MARGIN_CASH_ASSET_DETAIL_INQUIRY" />
  <value enum="6" description="COLLATERAL_DETAIL_INQUIRY" />
  <value enum="7" description="COLLATERAL_SECURITY_INFO_INQUIRY" />
  <value enum="8"
description="COLLATERAL_SECURITY_PRINCIPAL_REDEMPTION_DETAILS" />
  <value enum="9" description="MARGIN_CASH_INTEREST_REPORT_INQUIRY" />
  <value enum="10" description="MARGIN_SECURITY_INTEREST_REPORT_INQUIRY" />
</field>
<field number="10541" name="IssuerCountry" description="The country of
security issuer" type="STRING" />
<field number="10542" name="ForeNoticeIndic" description="" type="BOOLEAN">
  <value enum="Y" description="YES" />
  <value enum="N" description="NO" />
</field>
<field number="10543" name="U35DataType" description="" type="INT">
  <value enum="0" description="SETTLEMENT_REPORT_INQUIRY" />
  <value enum="1" description="INTEREST_REPORT_INQUIRY" />
  <value enum="2"
description="MARKET_VALUE_BALANCE_AND_CHANGES_INQUIRY_OF_MARGIN_SECURITY" />
  <value enum="3"
description="MARKET_VALUE_BALANCE_AND_CHANGES_INQUIRY_OF_MARGIN_CASH" />
  <value enum="4" description="MARGIN_CASH_ASSET_DETAIL_INQUIRY" />
  <value enum="5" description="MARGIN_CASH_SUPPLEMENTAL_DETAILS_INQUIRY" />
  <value enum="6" description="COLLATERAL_DETAIL_INQUIRY" />
  <value enum="7" description="COLLATERAL_SECURITY_INFO_DATA" />
  <value enum="8"
description="COLLATERAL_SECURITY_PRINCIPAL_REDEMPTION_DETAILS" />
  <value enum="9" description="SECURITY_EXPIRATION_REMINDER" />
  <value enum="10" description="MARGIN_CASH_INTEREST_REPORT" />
  <value enum="11" description="MARGIN_SECURITY_INTEREST_REPORT" />
</field>
<field number="10545" name="DrawCancelRespStatus" description="" type="INT">
  <value enum="0" description="CANCEL_REQUEST_SUCCEED" />
  <value enum="1" description="CANCEL_REQUEST_FAILED" />
</field>
<field number="10546" name="DrawCancelRejReason" description="The reject

```

```

reason of Collateral Draw Cancel Request" type="INT">
  <value enum="0" description="THE_REQUEST_ID_HAS_BEEN_CANCELLED_BEFORE" />
  <value enum="1" description="ACCEPTED" />
  <value enum="2" description="THE_REQUEST_ID_HAS_BEEN_REJECTED_BEFORE" />
  <value enum="3" description="THE_REQUEST_ID_IS_NOT_EXISTED" />
</field>
<field number="10547" name="AssignmentRespStatus" description="Collateral
Assignment Response Status" type="INT">
  <value enum="0" description="NORMAL" />
  <value enum="1" description="DUPLICATE_REQUEST_ID" />
  <value enum="2" description="WRONG_USER_ID_OR_INVALID_USER_ID" />
  <value enum="3" description="WRONG_COLLATERAL_TYPE" />
  <value enum="4" description="WRONG_PAYMENT_ROUTE" />
  <value enum="5" description="WRONG_COLLATERAL" />
  <value enum="6" description="WRONG_COLLATERAL_CURRENCY" />
  <value enum="7" description="WRONG_PAYMENT_AMOUNT" />
  <value enum="8" description="WRONG_SETTLEMENT_DATE" />
  <value enum="9" description="OTHERS" />
</field>
<field number="10548" name="CollTransferReqID" description="Collateral
Transfer Request ID" type="STRING" />
<field number="10549" name="TransferDirection" description="Transfer
Direction" type="INT">
  <value enum="1" description="CHANGEDCOLLATERAL_TO_BASECOLLATERAL" />
  <value enum="2" description="BASECOLLATERAL_TO_CHANGEDCOLLATERAL" />
</field>
<field number="10550" name="TransferReqType" description="Transfer Request
Type" type="INT">
  <value enum="0" description="NEW_REQUEST" />
  <value enum="1" description="REQUEST_CACEL" />
</field>
<field number="10551" name="TransferRespStatus" description="Transfer
Response Status" type="INT">
  <value enum="0" description="APPLIED" />
  <value enum="1" description="ACCEPTED" />
  <value enum="2" description="REJECTED" />
  <value enum="3" description="CANCELLED" />
</field>
<field number="10552" name="TransferReqRejReason" description="The reject
reason of Margin Transfer Request" type="INT">
  <value enum="0" description="DUPLICATE_REQUEST_ID" />
  <value enum="1" description="WRONG_USER_ID_OR_INVALID_USER_ID" />
  <value enum="2" description="WRONG_CURRENCY" />

```

```

    <value enum="3" description="INSUFFICIENT_FUND" />
    <value enum="4" description="WRONG_TRANSFER_DIRECTION" />
    <value enum="5" description="OTHER_REASON" />
  </field>
  <field number="10553" name="CollTransferRespID" description="" type="STRING"
/>
  <field number="10554" name="NoMarginBaseInfo" description="The total number
of Margin information" type="NUMINGROUP" />
  <field number="10555" name="NoRateBaseInfo" description="The total number of
Rate information" type="NUMINGROUP" />
  <field number="10556" name="CollBaseInfoReqID" description="Collateral Base
Information Request ID" type="STRING" />
  <field number="10557" name="CollARInquiryID" description="Collateral
Assignment and Receive Inquiry ID" type="STRING" />
  <field number="10558" name="ARReportType" description="Assignment and Receive
Report Type" type="INT">
    <value enum="0" description="ASSIGNMENT_COLLATERAL_DETAIL_REPORT" />
    <value enum="1" description="RECEIVE_COLLATERAL_DETAIL_REPORT" />
    <value enum="2" description="RECEIVED_MARGIN_SECURITIES_DETAIL_REPORT" />
  </field>
  <field number="10559" name="CollARDtlRptID" description="Collateral
Assignment and Receive Detail Report ID" type="STRING" />
  <field number="10560" name="CollARRptStatus" description="Collateral
Assignment and Receive Report Status" type="INT">
    <value enum="0" description="NORMAL" />
    <value enum="1" description="NO_RECORD" />
    <value enum="2" description="WRONG_CLEARING_DATE" />
    <value enum="3" description="OTHER_ERRORS" />
  </field>
  <field number="10561" name="NoMarginARs" description="The total number of
Collateral Assignment and Receive Details" type="NUMINGROUP" />
  <field number="10562" name="SettRepConInquiryID" description="Settlement
Report Confirmed Inquiry ID" type="STRING" />
  <field number="10563" name="SettRepConDtlID" description="Settlement Report
COnfirmed Detail ID" type="STRING" />
  <field number="10564" name="BulletinInqID" description="Bulletin Inquiry ID"
type="STRING" />
  <field number="10565" name="SelfConfStatus" description="" type="INT">
    <value enum="0" description="DEFAULT_UNCONFIRMED" />
    <value enum="1" description="CONFIRMED" />
    <value enum="2" description="DO_NOT_CONFIRMED" />
    <value enum="3" description="CONTINGENCY_CONFIRMED" />
    <value enum="4" description="CONTINGENCY_CANCELLED" />
  </field>

```



```

</field>
<field number="10566" name="CPConfStatus" description="Counterparty
Confirmed Status" type="INT">
  <value enum="0" description="DEFAULT_UNCONFIRMED" />
  <value enum="1" description="CONFIRMED" />
  <value enum="2" description="DO_NOT_CONFIRMED" />
  <value enum="3" description="CONTINGENCY_CONFIRMED" />
  <value enum="4" description="CONTINGENCY_CANCELLED" />
</field>
<field number="10567" name="SettlInstReqType" description="settlement
instruction request type" type="INT">
  <value enum="0" description="SETTLEMENT_REPORT_INQUIRY_BY_SETTLEMENT_BANK"
/>
  <value enum="1" description="SETTLEMENT_REPORT_INQUIRY_BY_CLEARING_MEMBER"
/>
  <value enum="2" description="SETTLEMENT_REPORT_INQUIRY_BY_TRADING_MEMBER"
/>
  <value enum="3"
description="SETTLEMENT_TRACKING_INQUIRY_BY_TRADING_MEMBER" />
  <value enum="4" description="LEG_INFORMATION_INQUIRY" />
</field>
<field number="10568" name="SettRepCnfID" description="Settlement Report
Confirmed Message ID" type="STRING" />
  <field number="10569" name="BulletinCaption" description="Bulletin Caption"
type="STRING" />
  <field number="10570" name="BulletinID" description="Bulletin ID"
type="STRING" />
  <field number="10571" name="BulletinStatus" description="" type="INT">
  <value enum="0" description="NORMAL" />
  <value enum="1" description="NO_RECORD" />
  <value enum="2" description="WRONG_CLEARING_DATE" />
  <value enum="3" description="OTHER_ERRORS" />
</field>
<field number="10572" name="BulletinRptID" description="Bulletin Report ID"
type="STRING" />
  <field number="10573" name="DrawRespID" description="Collateral Draw Response
ID" type="STRING" />
  <field number="10574" name="NoBulletins" description="The total number of
Bulletins" type="NUMINGROUP" />
  <field number="10575" name="DrawCancelRespID" description="Collateral Draw
Cancel Response ID" type="STRING" />
  <field number="10576" name="CollBaseInfoID" description="Collateral Base
Information ID" type="STRING" />

```



```

<field number="10577" name="CollTransferCnclID" description="Collateral
Transfer Request Cancel ID" type="STRING" />
<field number="10578" name="OrdStatusReqType" description="" type="INT">
  <value enum="0" description="EXEC_STATUS" />
  <value enum="1" description="STATUS" />
  <value enum="2" description="REQUEST_RECOVERY" />
  <value enum="3" description="SUBMIT_STATUS" />
</field>
<field number="10579" name="HoldRequestID" description="" type="STRING" />
<field number="10580" name="CCYSettlBank" description="The english short name
of settlement bank" type="STRING" />
<field number="10581" name="MarginMinTickSize" description="Margin Cash
Minimum Ticket Size" type="AMT" />
<field number="10582" name="CollAsgnRespID" description="Collateral
Assignment Response ID" type="STRING" />
<field number="10583" name="DrawReqRejReason" description="Draw Request
Reject Reason" type="INT">
  <value enum="0" description="DUPLICATE_REQUEST_ID" />
  <value enum="1" description="WRONG_USER_ID_OR_INVALID_USER" />
  <value enum="2" description="WRONG_COLLATERAL_TYPE" />
  <value enum="3" description="WRONG_COLLATERAL" />
  <value enum="4" description="WRONG_COLLATERAL_CURRENCY" />
  <value enum="5" description="WRONG_DRAW_AMOUNT" />
  <value enum="6" description="OTHER" />
</field>
<field number="10584" name="DrawCancelRequestID" description="Draw Cancel
Request ID" type="STRING" />
<field number="10585" name="SecurityAttribute" description="" type="INT">
  <value enum="0" description="BENCHMARK_SECURITY" />
  <value enum="1" description="SAMPLE_SECURITY" />
  <value enum="2" description="COMMON_SECURITY" />
</field>
<field number="10586" name="LegQuotetime" description="Quote time"
type="UTCTIMESTAMP" />
<field number="10587" name="KCurveType" description="" type="INT">
  <value enum="0" description="K_CURVE_BY_DAILY" />
  <value enum="1" description="K_CURVE_BY_WEEKLY" />
  <value enum="2" description="K_CURVE_BY_MONTHLY" />
</field>
<field number="10588" name="LegInterestAccuralDaysAdjustment"
description="Interest Accural Days Adjustment" type="CHAR">
  <value enum="0" description="NO_ADJUSTMENT" />
  <value enum="1" description="ACTUAL_DAYS" />

```

```

</field>
<field number="10589" name="SWIFTType" description="" type="STRING" />
<field number="10590" name="QuoteSN" description="Quote serial number used in
database. It will change if the initial quote is modified." type="STRING" />
<field number="10591" name="SecSettleLocation" description="" type="STRING"
/>
<field number="10592" name="LimitSubType" description="sub type of limit data"
type="INT">
<value enum="0" description="BORROW_BUY_REPO_LIMIT_OR_MAXIMUM_NET_LIMIT"
/>
<value enum="1"
description="LEND_SELL_REVERSE_REPO_LIMIT_OR_MINIMUM_NET_LIMIT" />
<value enum="2" description="UTILIZED_BORROW_BUY_REPO_LIMIT" />
<value enum="3" description="UTILIZED_LEND_SELL_REVERSE_REPO_LIMIT" />
<value enum="4"
description="AVAILABLE_BORROW_BUY_REPO_LIMIT_OR_AVAILABLE_NET_BORROW_BUY_REPO
_LIMIT" />
<value enum="5"
description="AVAILABLE_LEND_SELL_REVERSE_REPO_LIMIT_OR_AVAILABLE_NET_LEND_SEL
L_REVERSE_REPO_LIMIT" />
<value enum="6" description="UTILIZED_NET_LIMIT" />
</field>
<field number="10593" name="LegDataSource" description="&lt;span
style=&quot;font-size:10pt;background:lime;font-family:'Times New
Roman'&gt;&lt;/span&gt;" type="STRING">
<value enum="0" description="REAL_TIME_QUOTE_DATA" />
<value enum="1" description="CURRENT_DAY_QUOTE_DATA" />
<value enum="2" description="CURRENCY_BROKER_QUOTE_DATA" />
<value enum="3" description="HISTORY_QUOTE_DATA" />
<value enum="4" description="FITTING_DATA" />
</field>
<field number="10594" name="AbnorExecDesc" description="" type="STRING" />
<field number="10595" name="InquiryLayer" description="inquiry layer"
type="INT">
<value enum="0" description="INSTITUTION" />
<value enum="1" description="TRADER" />
</field>
<field number="10596" name="NoLimitSubInfo" description="number of
LimitInfoSubGrp" type="NUMINGROUP" />
<field number="10597" name="LimitTransType" description="" type="INT">
<value enum="0" description="RESULT_OF_LIMIT_INQUERY" />
<value enum="1" description="ADD_NEW_LIMIT_DATA" />
<value enum="2" description="MODIFY_LIMIT_DATA" />

```

```

    <value enum="3" description="DELETE_LIMIT_DATA" />
  </field>
  <field number="10598" name="LegDisplayQty" description="The quantity to be
  displayed . Required for reserve orders . On orders specifies the qty to be displayed,
  on execution reports the currently displayed quantity." type="QTY" />
  <field number="10599" name="LimitInfoID" description="The ID of LimitInfo(U26) .
  It is used in U26 and U70(LimitInfoAck)." type="STRING" />
  <field number="10600" name="LimitInfoStatus" description="The status of Limit
  Info Data." type="INT">
    <value enum="0" description="ACCEPTED" />
    <value enum="1" description="REJECTED" />
  </field>
  <field number="10601" name="NoContactInfos" description="number of
  ContactInfoGrp." type="NUMINGROUP" />
  <field number="10602" name="ContactInfoID" description="ContactInfoID"
  type="STRING" />
  <field number="10603" name="ContactInfoIDType" description="Type of detailed
  contact info." type="INT">
    <value enum="0" description="ADDRESS_LINE_1" />
    <value enum="1" description="ADDRESS_LINE_2" />
    <value enum="2" description="ADDRESS_COUNTRY" />
    <value enum="3" description="ADDRESS_STATE" />
    <value enum="4" description="ADDRESS_CITY" />
    <value enum="5" description="ZIP_CODE" />
    <value enum="6" description="PHONE_NO_1" />
    <value enum="7" description="PHONE_NO_2" />
    <value enum="8" description="FAX_NO_1" />
    <value enum="9" description="FAX_NO_2" />
    <value enum="10" description="E_MAIL_ID" />
    <value enum="11" description="MSN" />
    <value enum="12" description="ENTERPRISE_LEGAL_PERSON" />
    <value enum="13" description="WEB_SITE" />
  </field>
  <field number="10604" name="PartyInfoStatus" description="The status of party
  info." type="INT">
    <value enum="0" description="ACCEPTED" />
    <value enum="1" description="REJECTED" />
  </field>
  <field number="10605" name="BusinessDtldataID" description="data record ID."
  type="STRING" />
  <field number="10606" name="LastRptCurrPage" description="indicate whether
  the current message is the last one of the current page or not." type="BOOLEAN">
    <value enum="Y" description="YES" />

```

```

    <value enum="N" description="NO" />
</field>
<field number="10607" name="MsgNumofCurrPage" description="The message number
of the current page." type="INT" />
<field number="10608" name="BulletinTransType" description="action type of
bulletin message." type="INT">
    <value enum="0" description="RESULT_OF_BULLETIN_INQUERY" />
    <value enum="1" description="ADD_NEW_BULLETIN_DATA" />
    <value enum="2" description="MODIFY_BULLETIN_DATA" />
    <value enum="3" description="DELETE_BULLETIN_DATA" />
</field>
<field number="10609" name="BulletinInfoStatus" description="" type="INT">
    <value enum="0" description="ACCEPTED" />
    <value enum="1" description="REJECT" />
</field>
<field number="10610" name="SentOrReceived" description="" type="INT">
    <value enum="0" description="SENT" />
    <value enum="1" description="RECEIVED" />
</field>
<field number="10611" name="BulletinByIndc" description="Bulletin set by
indicator." type="INT">
    <value enum="0" description="BULLETIN_SET_BY_MSC_USER" />
    <value enum="1" description="BULLETIN_SET_BY_MBO_USER" />
    <value enum="2" description="BULLETIN_SET_AUTOMATICALLY" />
    <value enum="3" description="ALL" />
</field>
<field number="10612" name="PreferIndicator" description="Preferred
Indicator" type="BOOLEAN">
    <value enum="Y" description="YES" />
    <value enum="N" description="NO" />
</field>
<field number="10613" name="PartyTransType" description="action type of
PartyInfo" type="INT">
    <value enum="0" description="ADD" />
    <value enum="1" description="MODIFY" />
    <value enum="2" description="DELETE" />
</field>
<field number="10614" name="SettlementStatus" description="Settlement
Status" type="INT">
    <value enum="0" description="SETTLED" />
    <value enum="1" description="UNSETTLED" />
</field>
<field number="10615" name="LegInfrmnIndicator" description="Leg Information

```

```

Indicator" type="INT" />
  <field number="10616" name="RatioType" description="比率类型" type="INT">
    <value enum="0" description="SINGLE_BOND_OUTRIGHT_REPO_RATIO" />
    <value enum="1" description="MULTIPLE_BOND_OUTRIGHT_REPO_RATIO" />
    <value enum="2" description="UNILATERAL_BUY_RATIO" />
    <value enum="3" description="UNILATERAL_SELL_RATIO" />
    <value enum="4" description="NET_BUYING_RATIO" />
    <value enum="5" description="GROSS_SELLING_RATIO" />
  </field>
  <field number="10617" name="SetRatio" description="ratio set by market
server." type="FLOAT" />
  <field number="10618" name="UtilizedRatio" description="utilized ratio"
type="FLOAT" />
  <field number="10619" name="NoRatioData" description="Number of RatioDataGrp"
type="NUMINGROUP" />
  <field number="10620" name="AvailableRatio" description="Available Ratio"
type="FLOAT" />
  <field number="10621" name="NoTradeFees" description="" type="NUMINGROUP" />
  <field number="10622" name="NetCashFlowPV" description="PV of Net Cash Flow"
type="AMT" />
  <field number="10623" name="DV01" description="DV01" type="FLOAT" />
  <field number="10624" name="BenchmarkResetFrequency" description="Benchmark
Curve Reset Frequency" type="STRING">
    <value enum="0" description="SEMI_ANNUALLY" />
    <value enum="1" description="ANNUALLY" />
    <value enum="2" description="MATURITY" />
    <value enum="3" description="MONTHLY" />
    <value enum="4" description="QUARTERLY" />
    <value enum="5" description="BIWEEKLY" />
    <value enum="6" description="WEEKLY" />
    <value enum="7" description="DAILY" />
    <value enum="1D" description="LEGSETTLTYPE_VALUE_1D" />
    <value enum="7D" description="LEGSETTLTYPE_VALUE_7D" />
    <value enum="10D" description="LEGSETTLTYPE_VALUE_10D" />
    <value enum="1W" description="LEGSETTLTYPE_VALUE_1W" />
    <value enum="2W" description="LEGSETTLTYPE_VALUE_2W" />
    <value enum="3W" description="LEGSETTLTYPE_VALUE_3W" />
    <value enum="1M" description="LEGSETTLTYPE_VALUE_1M" />
    <value enum="2M" description="LEGSETTLTYPE_VALUE_2M" />
    <value enum="3M" description="LEGSETTLTYPE_VALUE_3M" />
    <value enum="4M" description="LEGSETTLTYPE_VALUE_4M" />
    <value enum="5M" description="LEGSETTLTYPE_VALUE_5M" />
    <value enum="6M" description="LEGSETTLTYPE_VALUE_6M" />

```

```

<value enum="7M" description="LEGSETTLTYPE_VALUE_7M" />
<value enum="8M" description="LEGSETTLTYPE_VALUE_8M" />
<value enum="9M" description="LEGSETTLTYPE_VALUE_9M" />
<value enum="10M" description="LEGSETTLTYPE_VALUE_10M" />
<value enum="11M" description="LEGSETTLTYPE_VALUE_11M" />
<value enum="1Y" description="LEGSETTLTYPE_VALUE_1Y" />
<value enum="2Y" description="LEGSETTLTYPE_VALUE_2Y" />
<value enum="3Y" description="LEGSETTLTYPE_VALUE_3Y" />
<value enum="4Y" description="LEGSETTLTYPE_VALUE_4Y" />
<value enum="5Y" description="LEGSETTLTYPE_VALUE_5Y" />
<value enum="6Y" description="LEGSETTLTYPE_VALUE_6Y" />
<value enum="7Y" description="LEGSETTLTYPE_VALUE_7Y" />
<value enum="8Y" description="LEGSETTLTYPE_VALUE_8Y" />
<value enum="9Y" description="LEGSETTLTYPE_VALUE_9Y" />
<value enum="10Y" description="LEGSETTLTYPE_VALUE_10Y" />
<value enum="11Y" description="LEGSETTLTYPE_VALUE_11Y" />
<value enum="12Y" description="LEGSETTLTYPE_VALUE_12Y" />
<value enum="13Y" description="LEGSETTLTYPE_VALUE_13Y" />
<value enum="14Y" description="LEGSETTLTYPE_VALUE_14Y" />
<value enum="15Y" description="LEGSETTLTYPE_VALUE_15Y" />
<value enum="20Y" description="LEGSETTLTYPE_VALUE_20Y" />
</field>
<field number="10625" name="ExecRptDataIndic" description="Data indicator of
Excution Report" type="INT">
  <value enum="0" description="EXECUTION_REPORT" />
  <value enum="1" description="OPEN_CONTRACT_AGENT_DATA" />
  <value enum="2" description="CALCULATION_AGENT_DATA" />
</field>
<field number="10626" name="SecLstUptRptStatus" description="" type="INT">
  <value enum="0" description="ACCEPTED" />
  <value enum="1" description="REJECT" />
</field>
<field number="10627" name="NoPrvlges" description="used in repeating group
PrvlgeGrp." type="NUMINGROUP" />
  <field number="10628" name="PrvlgeCategory" description="Privilege
Category." type="INT">
    <value enum="0" description="TRADING_PRIVILEGE" />
    <value enum="1" description="MONITOR_PRIVILEGE" />
  </field>
  <field number="10629" name="PrvlgeIndicator" description="whether privilege
is selected." type="INT">
    <value enum="0" description="PRIVILEGE_IS_SELECTED" />
    <value enum="1" description="PRIVILEGE_IS_NOT_SELECTED" />
  </field>

```

```

</field>
<field number="10630" name="NoFundValues" description="" type="NUMINGROUP" />
<field number="10631" name="NetTotalIndicator" description="" type="INT">
  <value enum="0" description="NET_FUND_VALUE" />
  <value enum="1" description="TOTAL_NET_FUND_VALUE" />
</field>
<field number="10632" name="FundValue" description="" type="AMT" />
<field number="10633" name="FundValueRptID" description="" type="STRING" />
<field number="10634" name="FundValueRptType" description="" type="INT">
  <value enum="0" description="NEW" />
</field>
<field number="10635" name="FundValueRptStatus" description="" type="INT">
  <value enum="0" description="SUCCEED" />
  <value enum="1" description="FAILED" />
</field>
<field number="10636" name="CNYTradedIndic" description="" type="STRING">
  <value enum="Y" description="RMB_TRADING" />
  <value enum="N" description="FOREIGN_CURRENCY_TRADING" />
</field>
<field number="10637" name="CaculateSign" description="3-multiply;4-divide;"
type="STRING">
  <value enum="3" description="LEGSETTLTYPE_VALUE_3" />
  <value enum="4" description="LEGSETTLTYPE_VALUE_4" />
</field>
<field number="10638" name="PartyStatus" description="Party Status"
type="INT">
  <value enum="0" description="ACTIVITY" />
  <value enum="1" description="OUT_OF_MARKET" />
  <value enum="2" description="STOP_TRADING" />
</field>
<field number="10639" name="SubmitTime" description="submit time"
type="UTCTIMESTAMP" />
<field number="10640" name="ReceivingDate" description="Receiving Date"
type="LOCALMKTDATE" />
<field number="10641" name="LegQuoteID" description="QuoteID" type="STRING"
/>
<field number="10642" name="LegOrdSeqNo" description="Order sequence number."
type="SEQNUM" />
<field number="10643" name="NoLegPartyIDs" description="" type="NUMINGROUP"
/>
<field number="10644" name="LegPartyID" description="member id" type="STRING"
/>
<field number="10645" name="LegPartyRole" description="party role"

```

```

type="INT">
    <value enum="101" description="INITIATOR" />
    <value enum="102" description="COUNTERPARTY" />
</field>
<field number="10646" name="NoLegPartySubIDs" description=""
type="NUMINGROUP" />
<field number="10647" name="LegPartySubID" description="member sub id"
type="STRING" />
<field number="10648" name="LegPartySubIDType" description="party sub id type"
type="INT">
    <value enum="124" description="FULL_LEGAL_CHINESE_NAME_OF_FIRM" />
    <value enum="125" description="SHORT_LEGAL_CHINESE_NAME_OF_FIRM" />
</field>
<field number="10649" name="NoMMsets" description="" type="NUMINGROUP" />
<field number="10650" name="NoMMLegs" description="" type="NUMINGROUP" />
<field number="10651" name="FreeMsgID" description="" type="STRING" />
<field number="10652" name="FreeMsgType" description="" type="STRING" />
<field number="10653" name="FullSymbol" description="" type="STRING" />
<field number="10654" name="CreditRatingType" description="" type="INT">
    <value enum="0" description="CREDIT_RATING_FOR_ISSUER" />
    <value enum="1" description="CREDIT_RATING_FOR_UNDERLYINGISSUER" />
    <value enum="2" description="CREDIT_RATING_FOR_UNDERLYINGLOAN" />
    <value enum="3" description="CREDIT_RATING_FOR_COLLATERAL_INSTITUTION" />
    <value enum="4" description="CREDIT_RATING_FOR_SUBSIDIARY_INSTITUTION" />
    <value enum="5" description="CREDIT_RATING_FOR_SECURITY" />
</field>
<field number="10655" name="DeliveryDesc" description="" type="STRING" />
<field number="10656" name="FeeMethod" description="" type="STRING">
    <value enum="1" description="PIPS" />
    <value enum="2" description="TERM" />
</field>
<field number="10657" name="WithdrawIndic" description="" type="BOOLEAN">
    <value enum="Y" description="WITHDRAW" />
    <value enum="N" description="CAN_NOT_WITHDRAW" />
</field>
<field number="10658" name="SecurityDefinitionStatus" description=""
type="INT">
    <value enum="0" description="SUCCESSFUL" />
    <value enum="1" description="FAILED" />
</field>
<field number="10659" name="CalculateAgencyDesc" description=""
type="STRING" />
<field number="10660" name="SettlTime" description="settlement time"

```



```

type="UTCTIMEONLY" />
  <field number="10661" name="SingleDataIndic" description="Single Data
Indicator" type="BOOLEAN">
    <value enum="Y" description="YES" />
    <value enum="N" description="NO" />
  </field>
  <field number="10662" name="JournalEntryReqID" description="journal entry
request ID." type="STRING" />
  <field number="10663" name="BatchCode" description="batch code, in the trading
time or out of the trading time." type="STRING" />
  <field number="10664" name="KeepFolder" description="keepfolder."
type="STRING" />
  <field number="10665" name="Account" description="Account." type="STRING" />
  <field number="10666" name="AccountCode" description="type of account."
type="STRING" />
  <field number="10667" name="AccountDesc" description="account name."
type="STRING" />
  <field number="10668" name="InBalShtIndic" description="in or out of balance
sheet." type="BOOLEAN">
    <value enum="Y" description="YES" />
    <value enum="N" description="NO" />
  </field>
  <field number="10669" name="AccountAmount" description="account amount."
type="AMT" />
  <field number="10670" name="JournalEntryStatus" description="the return type
of journal entry request. " type="INT">
    <value enum="0" description="NORMAL" />
    <value enum="1" description="NO_DATA_MATCHED" />
    <value enum="2" description="DO_NOT_ENTRY_A_QUERY" />
    <value enum="3" description="ACCOUNT_OR_PASSWORD_ERROR" />
    <value enum="4" description="NO_MEMBER_MATCHED" />
    <value enum="5" description="CONNECTION_FAILED" />
    <value enum="6" description="INTERFACE_DOES_NOT_START" />
    <value enum="7" description="MANDATORY_FIELD_MISSED" />
    <value enum="8" description="CONTAIN_AN_UNDEFINED_STRING" />
    <value enum="9" description="NO_DATA_TYPE_MATCHED" />
    <value enum="10" description="QUERY_OVERFLOW" />
    <value enum="11" description="MESSAGE_ACTION_ERROR" />
    <value enum="12" description="DATA_IS_ADDING" />
    <value enum="13" description="DATA_IS_DELETING" />
    <value enum="14" description="CAN_NOT_FIND_ORIGINAL_ACTUAL_P_OR_R_DATA" />
    <value enum="15" description="CAN_NOT_FIND_ORIGINAL_ACCRUED_P_OR_R_DATA"
/>
/>

```

```

    <value enum="16" description="USELESS_INTERFACE" />
    <value enum="17"
description="CAN_NOT_UPLOAD_BECAUSE_IT_HAS_BEEN_PROCESSED" />
    <value enum="18"
description="CAN_NOT_DELETE_BECAUSE_IT_HAS_NOT_BEEN_PROCESSED" />
    <value enum="19" description="CAN_NOT_BE_DELETED_REPEATLY" />
    <value enum="20"
description="CAN_NOT_BE_DELETED_BECAUSE_THE_SETTLEMENT_DATE_HAS_BEEN_PASSED"
/>
    <value enum="21" description="PROCESS_FAILED" />
    <value enum="22" description="NO_DATA_RETURN_BECAUSE_NO_QUERY_ENTER" />
</field>
<field number="10671" name="ProcessStatus" description="processing feedback
from message receiver." type="INT">
    <value enum="0" description="SUCCEED" />
    <value enum="1" description="FAILED" />
</field>
<field number="10672" name="MessageID" description="Message ID."
type="STRING" />
<field number="10673" name="JournalEntryID" description="Journal Entry ID."
type="STRING" />
<field number="10674" name="BundleCode" description="Bundle Code"
type="STRING" />
<field number="10675" name="LegNetGrossInd" description="Clearing Method."
type="INT">
    <value enum="1" description="NET_NEGOTIATION" />
    <value enum="2" description="GROSS" />
    <value enum="3" description="NET_MATCH" />
</field>
<field number="10676" name="PortfolioName" description="" type="STRING" />
<field number="10677" name="PortfolioID" description="" type="STRING" />
<field number="10678" name="InterestAccrualResetFrequency" description=""
type="STRING">
    <value enum="1Y" description="LEGSETTLTYPE_VALUE_1Y" />
    <value enum="6M" description="LEGSETTLTYPE_VALUE_6M" />
    <value enum="3M" description="LEGSETTLTYPE_VALUE_3M" />
    <value enum="1M" description="LEGSETTLTYPE_VALUE_1M" />
</field>
<field number="10679" name="InterestCurrency" description="" type="CURRENCY"
/>
<field number="10680" name="Industry" description="" type="STRING" />
<field number="10681" name="FloatRateInd" description="" type="INT">
    <value enum="1" description="POSITIVE" />

```

```

    <value enum="2" description="NEGATIVE" />
</field>
<field number="10682" name="UnderlyingDiscountAmt" description="" type="AMT"
/>
<field number="10683" name="TotalDiscountAmt" description="" type="AMT" />
<field number="10684" name="QueryResultStatus" description="Query Result
Status." type="INT">
    <value enum="0" description="QUERY_SUCCESS" />
    <value enum="1" description="QUERY_FAILED" />
</field>
<field number="10685" name="SubscriptionRequestID" description="Subscription
Request ID" type="STRING" />
<field number="10686" name="SubscriptionStatus" description="Subscription
Status" type="INT">
    <value enum="0" description="ACCEPTED" />
    <value enum="1" description="REJECTED" />
</field>
<field number="10687" name="DataSourceString" description="Data Source."
type="STRING" />
<field number="10688" name="QuoteMode" description="" type="INT">
    <value enum="0" description="API_QUOTATION" />
    <value enum="1" description="PRICE_ENGINE_QUOTATION" />
    <value enum="2" description="TRANSACTION_QUOTATION" />
</field>
<field number="10689" name="SubscriptionTransType" description="Subscription
Message Type" type="INT">
    <value enum="0" description="SUBSCRIPTION" />
    <value enum="1" description="CANCEL_SUBSCRIPTION" />
</field>
<field number="10690" name="RatedObjectName" description="" type="STRING" />
<field number="10691" name="RatedExpect" description="" type="STRING">
    <value enum="0" description="POSITIVE" />
    <value enum="1" description="STABLE" />
    <value enum="2" description="NEGATIVE" />
    <value enum="3" description="POSSIBLY_INCREASED" />
    <value enum="4" description="POSSIBLY_REDUCED" />
    <value enum="5" description="UNKNOWN_TREND" />
</field>
<field number="10692" name="RatedObjectID" description="" type="STRING" />
<field number="10693" name="ReminderDate" description="" type="UTCDATEONLY"
/>
<field number="10694" name="ReminderEvent" description="" type="STRING">
    <value enum="0" description="ISSUE" />

```

```

    <value enum="1" description="PAYMENT" />
    <value enum="2" description="LISTING" />
    <value enum="3" description="DELISTING" />
    <value enum="4" description="CALL" />
    <value enum="5" description="INTEREST_PAYMENT" />
    <value enum="6" description="REGISTRATION_OF_NEW_SECURITY" />
    <value enum="7" description="ISSUE_OF_ANNOUNCEMENTS" />
    <value enum="8" description="SECURITY_CIRCULATION_ANNOUNCEMENTS" />
    <value enum="9" description="SECURITY_INTEREST_PAYMENT_ANNOUNCEMENTS" />
    <value enum="10" description="SECURITY_RATING_UPDATE_ANNOUNCEMENTS" />
    <value enum="11" description="INSTITUTION_RATING_UPDATE_ANNOUNCEMENTS" />
    <value enum="12" description="BIG_NEWS" />
    <value enum="13" description="INTEREST_RATE_ADJUSTMENT" />
    <value enum="14" description="ISSUER_INFORMATION_UPDATE" />
</field>
<field number="10695" name="ReminderType" description="" type="STRING">
    <value enum="0" description="SECURITY" />
    <value enum="1" description="INSTITUTION" />
</field>
<field number="10696" name="ReminderObjectName" description="" type="STRING"
/>
<field number="10697" name="ReminderObjectID" description="" type="STRING" />
<field number="10698" name="SecurityISINID" description="" type="STRING" />
<field number="10699" name="IssuerProperty" description="" type="STRING">
    <value enum="0" description="LIMITED_LIABILITY_COMPANY" />
    <value enum="1" description="CO_LTD" />
    <value enum="2" description="STATE_OWNED_COMPANY" />
    <value enum="3" description="SOLE_PROPRIETORSHIP_ENTERPRISE" />
    <value enum="4" description="PARTNERSHIP_ENTERPRISE" />
    <value enum="5" description="INDIVIDUAL_BUSINESSES" />
    <value enum="6" description="FOREIGN_INVESTED_ENTERPRISES" />
    <value enum="7" description="PRIVATE_OWNED_COMPANY" />
    <value enum="8" description="THE_WHOLE_PEOPLE_ENTERPRISE" />
    <value enum="9" description="COLLECTIVELY_OWNED_ENTERPRISES" />
    <value enum="99" description="OTHER" />
</field>
<field number="10700" name="EstablishDate" description="" type="UTCDATEONLY"
/>
<field number="10701" name="RegisteredCapital" description="" type="QTY" />
<field number="10702" name="ListedIndicator" description="" type="BOOLEAN">
    <value enum="Y" description="Y" />
    <value enum="N" description="N" />
</field>

```

```

<field number="10703" name="NoUnderwriter" description="" type="NUMINGROUP"
/>
<field number="10704" name="UnderwriterType" description="" type="STRING">
  <value enum="0" description="PRIMER_UNDERWRITER" />
  <value enum="1" description="CO_PRIMER_UNDERWRITER" />
  <value enum="2" description="SUBSIDIARY_UNDERWRITER" />
</field>
<field number="10705" name="UnderwriterName" description="" type="STRING" />
<field number="10706" name="IssueMethod" description="" type="STRING">
  <value enum="0" description="PRICE_OFFERING" />
  <value enum="1" description="INTEREST_RATE_OFFERING" />
  <value enum="2" description="SPREAD_OFFERING" />
  <value enum="3" description="BOOKKEEPING" />
  <value enum="4" description="PRIVATE_EQUITY" />
</field>
<field number="10707" name="OfferMethod" description="" type="STRING">
  <value enum="0" description="HOLLAND" />
  <value enum="1" description="AMERICAN" />
  <value enum="2" description="HYBRID" />
</field>
<field number="10708" name="UnderWriteMethod" description="" type="STRING">
  <value enum="0" description="UNDERWRITING_COMMISSION" />
  <value enum="1" description="BALANCE_OF_UNDERWRITING" />
  <value enum="2" description="FULL_UNDERWRITING" />
</field>
<field number="10709" name="IssueSizeForPlan" description="" type="AMT" />
<field number="10710" name="MarketRangeType" description="" type="INT">
  <value enum="0" description="ISSUEMARKET" />
  <value enum="1" description="DEALMARKET" />
</field>
<field number="10711" name="NoMarketRange" description="" type="NUMINGROUP"
/>
<field number="10712" name="InterstAllocationMethod" description=""
type="STRING">
  <value enum="0" description="AVERAGE_ALLOCATION" />
  <value enum="1" description="BY_ACTUAL_DAYS" />
</field>
<field number="10713" name="RoundOffType" description="" type="STRING">
  <value enum="0" description="NORMAL" />
  <value enum="1" description="REMOVE_PLACES" />
</field>
<field number="10714" name="CollRatio" description="" type="PERCENTAGE" />
<field number="10715" name="NoCollAppl" description="" type="NUMINGROUP" />

```

```

    <field number="10716" name="NoMarginPartyIDs" description=""
type="NUMINGROUP" />
    <field number="10717" name="MarginPartyID" description="" type="STRING" />
    <field number="10718" name="NoMarginPartySubIDs" description="" type="INT" />
    <field number="10719" name="MarginPartySubID" description="" type="STRING" />
    <field number="10720" name="MarginPartySubIDType" description="" type="INT">
    <value enum="0" description="COLLATERAL_INSTITUTION_NAME" />
    </field>
    <field number="10722" name="ComplexEventUnstrikeSpread" description=""
type="PRICEOFFSET" />
    <field number="10723" name="ComplexEventUnstrikeCouponRate" description=""
type="PERCENTAGE" />
    <field number="10724" name="ComplexEventDateType" description=""
type="STRING">
    <value enum="0" description="ANNOUNCEMENT_DATE" />
    <value enum="1" description="OPTION_EXERCISE_DATE" />
    <value enum="2" description="REGISTRATION_DATE" />
    </field>
    <field number="10725" name="ComplexEventSequence" description=""
type="NUMBER" />
    <field number="10726" name="RedemptionSequence" description="" type="NUMBER"
/>
    <field number="10727" name="RedemptionRatio" description=""
type="PERCENTAGE" />
    <field number="10728" name="NoSwapBonds" description="" type="NUMINGROUP" />
    <field number="10729" name="SwapBondSymbol" description="" type="STRING" />
    <field number="10730" name="SwapBondID" description="" type="STRING" />
    <field number="10731" name="SwapBondRatio" description="" type="STRING" />
    <field number="10732" name="NoSwapBondDates" description=""
type="NUMINGROUP" />
    <field number="10733" name="SwapBondOperDate" description=""
type="UTCDATEONLY" />
    <field number="10734" name="SwapBondAppFrom" description=""
type="UTCDATEONLY" />
    <field number="10735" name="SwapBondAppTo" description="" type="UTCDATEONLY"
/>
    <field number="10736" name="NoIssuer" description="" type="NUMINGROUP" />
    <field number="10737" name="IssuerLimit" description="" type="AMT" />
    <field number="10738" name="OPTDataType" description="" type="STRING">
    <value enum="1" description="OPTION_TRADING_DATA" />
    <value enum="2" description="OPTION_EXERCISE_DATA" />
    </field>
    <field number="10739" name="DerivativeExerciseStatus" description=""

```

```

type="INT">
  <value enum="1" description="VAILD" />
  <value enum="2" description="EXERCISED" />
  <value enum="3" description="EXPIRED" />
</field>
<field number="10740" name="MiscFeeDate" description="" type="UTCDATEONLY" />
<field number="10741" name="ExpireTimeZone" description="" type="STRING" />
<field number="10742" name="StrikeDayPrice" description="" type="PRICE" />
<field number="10743" name="StrikeUser" description="" type="STRING" />
<field number="10744" name="NoInheritInfo" description="" type="NUMINGROUP"
/>
  <field number="10745" name="InheritInstitutionName" description=""
type="STRING" />
  <field number="10746" name="InheritDesc" description="" type="STRING" />
  <field number="10747" name="InheritDate" description="" type="UTCDATEONLY" />
  <field number="10748" name="TradeSubType" description="" type="CHAR">
    <value enum="0" description="NORMAL_DEAL" />
    <value enum="9" description="DEAL_AFTER_MATCH" />
    <value enum="2" description="DERIVATIVE_OF_BOND_REDEMPTION" />
    <value enum="3" description="DERIVATIVE_OF_ROLLOVER_TRANSACTION" />
    <value enum="4" description="DERIVATIVE_OF_SPLIT" />
    <value enum="6" description="DERIVATIVE_OF_FINANCIAL_PRODUCTS_EXPIRATION"
/>
    <value enum="7" description="MATURITY_REDEMPTION_OF_NOTES_PACKAGE" />
    <value enum="8" description="DEAL_AFTER_DOUBLE_CHECK" />
    <value enum="A" description="DEAL_FROM_ORIGINAL" />
    <value enum="C" description="DERIVATIVE_OF_BUY_DISTRIBUTION" />
  </field>
  <field number="10749" name="TriggerIndicator" description="" type="BOOLEAN">
    <value enum="Y" description="LEGSETTLTYPE_VALUE_Y" />
    <value enum="N" description="LEGSETTLTYPE_VALUE_N" />
  </field>
  <field number="10750" name="TriggerDesc" description="" type="STRING" />
  <field number="10751" name="SecurityTermString" description="" type="STRING"
/>
  <field number="10752" name="IssuerAltName" description="" type="STRING" />
  <field number="10753" name="CpnPmtFreqDesc" description="" type="STRING" />
  <field number="10754" name="IntFixRtAdjmtDesc" description="" type="STRING"
/>
  <field number="10755" name="ReissueMethod" description="" type="STRING">
    <value enum="0" description="PRICE_OFFERING" />
    <value enum="1" description="INTEREST_RATE_OFFERING" />
    <value enum="2" description="SPREAD_OFFERING" />

```

```

    <value enum="3" description="BOOKKEEPING" />
    <value enum="4" description="PRIVATE_EQUITY" />
</field>
<field number="10756" name="ReissueOfferMethod" description=""
type="STRING" >
    <value enum="0" description="HOLLAND" />
    <value enum="1" description="AMERICAN" />
    <value enum="2" description="HYBRID" />
</field>
<field number="10757" name="ReissueSizeForPlan" description="" type="AMT" />
<field number="10758" name="ReissuePx" description="" type="PRICE" />
<field number="10759" name="NoReissueEvents" description=""
type="NUMINGROUP" />
<field number="10760" name="ReissueEventType" description="" type="INT">
    <value enum="1" description="ISSUE_END_DATE" />
    <value enum="2" description="BOOK_KEEPING_DATE" />
    <value enum="3" description="DISTRIBUTION_START_DATE" />
    <value enum="4" description="DISTRIBUTION_END_DATE" />
    <value enum="5" description="UNDERWRITER_PAYMENT_DATE" />
    <value enum="6" description="REGISTRATION_DATE_ON_CREDIT_AND_DEBT" />
    <value enum="7" description="TRADING_DATE_IN_INTER_BANK" />
</field>
<field number="10761" name="ReissueEventDate" description=""
type="UTCDATEONLY" />
<field number="10762" name="ExpectedMaturityDate" description="ABS"
type="UTCDATEONLY" />
<field number="10763" name="LegalMaturityDate" description="ABS"
type="UTCDATEONLY" />
</fields>
</imix>

```

附 录 B
 (资料性附录)
 IMIX 协议元数据模板结构定义

```

<?xml version="1.0" encoding="UTF-8"?>
<xs:schema xmlns:xs="http://www.w3.org/2001/XMLSchema" elementFormDefault="qualified">
  <xs:element name="imix">
    <xs:complexType>
      <xs:sequence>
        <xs:element ref="header"/>
        <xs:element ref="trailer"/>
        <xs:element ref="messages"/>
        <xs:element ref="components"/>
        <xs:element ref="fields"/>
      </xs:sequence>
      <xs:attribute name="major" use="required" type="xs:integer"/>
      <xs:attribute name="minor" use="required" type="xs:integer"/>
      <xs:attribute name="version" use="required" type="xs:decimal"/>
    </xs:complexType>
  </xs:element>
  <xs:element name="header">
    <xs:complexType>
      <xs:sequence>
        <xs:element maxOccurs="unbounded" ref="field"/>
        <xs:element ref="component"/>
      </xs:sequence>
    </xs:complexType>
  </xs:element>
  <xs:element name="trailer">
    <xs:complexType>
      <xs:sequence>
        <xs:element maxOccurs="unbounded" ref="field"/>
      </xs:sequence>
    </xs:complexType>
  </xs:element>
  <xs:element name="messages">
    <xs:complexType>
      <xs:sequence>
        <xs:element maxOccurs="unbounded" ref="message"/>
      </xs:sequence>
    </xs:complexType>
  </xs:element>

```

```

</xs:element>
<xs:element name="message">
  <xs:complexType>
    <xs:sequence>
      <xs:element maxOccurs="unbounded" ref="field"/>
      <xs:element minOccurs="0" maxOccurs="unbounded" ref="component"/>
    </xs:sequence>
    <xs:attribute name="description" use="required"/>
    <xs:attribute name="msgcat" use="required" type="xs:NCName"/>
    <xs:attribute name="msgtype" use="required" type="xs:NMTOKEN"/>
    <xs:attribute name="name" use="required" type="xs:NCName"/>
  </xs:complexType>
</xs:element>
<xs:element name="components">
  <xs:complexType>
    <xs:sequence>
      <xs:element maxOccurs="unbounded" ref="component"/>
    </xs:sequence>
  </xs:complexType>
</xs:element>
<xs:element name="fields">
  <xs:complexType>
    <xs:sequence>
      <xs:element maxOccurs="unbounded" ref="field"/>
    </xs:sequence>
  </xs:complexType>
</xs:element>
<xs:element name="field">
  <xs:complexType>
    <xs:sequence>
      <xs:element minOccurs="0" maxOccurs="unbounded" ref="value"/>
    </xs:sequence>
    <xs:attribute name="description"/>
    <xs:attribute name="name" use="required" type="xs:NCName"/>
    <xs:attribute name="number" type="xs:integer"/>
    <xs:attribute name="required" type="xs:NCName"/>
    <xs:attribute name="type" type="xs:NCName"/>
  </xs:complexType>
</xs:element>
<xs:element name="value">
  <xs:complexType>
    <xs:attribute name="description" use="required" type="xs:NCName"/>
    <xs:attribute name="enum" use="required" type="xs:NMTOKEN"/>

```

```
</xs:complexType>
</xs:element>
<xs:element name="component">
  <xs:complexType>
    <xs:sequence>
      <xs:element minOccurs="0" maxOccurs="unbounded" ref="field"/>
      <xs:choice minOccurs="0">
        <xs:element ref="component"/>
        <xs:element ref="group"/>
      </xs:choice>
    </xs:sequence>
    <xs:attribute name="description"/>
    <xs:attribute name="name" use="required" type="xs:NCName"/>
    <xs:attribute name="required" type="xs:NCName"/>
  </xs:complexType>
</xs:element>
<xs:element name="group">
  <xs:complexType>
    <xs:choice maxOccurs="unbounded">
      <xs:element ref="component"/>
      <xs:element ref="field"/>
    </xs:choice>
    <xs:attribute name="name" use="required" type="xs:NCName"/>
    <xs:attribute name="required" use="required" type="xs:NCName"/>
  </xs:complexType>
</xs:element>
</xs:schema>
```

参 考 文 献

- [1] GB/T 1988-1998 信息技术 信息交换用七位编码字符集
 - [2] GB 2312-1980 信息交换用汉字编码字符集 基本集
 - [3] GB/T 2659-2000 世界各国和地区名称代码
 - [4] GB/T 10113-2003 分类编码通用术语
 - [5] GB 11714-1997 全国组织机构代码编制规则
 - [6] GB/T 12402-2000 经济类型分类与代码
 - [7] GB/T 12406-1996 表示货币和资金的代码
 - [8] FIX4.4 金融信息交换协议4.4版
 - [9] ISO 10962-2001 Securities and Related Financial Instruments-Classification of Financial Instruments (CFI Code)-Second Edition
-